



buffet | tabletop | bar

GASTRONOMIE- UND SERVIERARTIKEL

FOOD SERVICE EQUIPMENT
EQUIPAMIENTOS PROFESIONALES
EQUIPEMENT PROFESSIONNEL



2019

SINCE 1933

Welcome

Gastronomie- und Servierartikel

food service equipment

equipamientos profesionales

équipement professionnel



Reinhold Pott

Johannes Becker



Familienunternehmen seit 1933

Als inhabergeführtes Unternehmen in der 4. Generation legt APS viel Wert auf Kontinuität, Innovation und Vertrauen.

As a family-run company in the 4th generation, we value continuity, innovation and trust

Como empresa familiar administrada por la 4ª generación ponemos mucho énfasis en la continuidad, la innovación y la confianza.

En tant qu'entreprise familiale gérée par la 4ème génération, nous partageons nos valeurs en termes de continuité, d'innovation et de confiance.

APS-Quality

Your partner for buffet, serving and bar items



APS | headoffice



storage | 30.000 storage bins



production | stainless steel trays



Assheuer + Pott GmbH & Co. KG

Talweg 11, 59846 Sundern, Germany
Telefon +49 (0) 29 33 / 97 35 - 0
Telefax +49 (0) 29 33 / 97 35 - 35 (Zentrale)
Telefax +49 (0) 29 33 / 97 35 - 34 (Export)

info@aps-germany.de | aps-germany.de



buffet | tabletop | bar



66



101



126

Buffet & Display



204



236



250

Buffet & Tableware Melamin



256



290



315

Tableware Tablepresentation



342



344

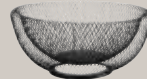

345

Körbe baskets cestas corbeilles



375



388



390

Chafing Dish, GN Container & Transport



408



414



452

Bar Café Drinkware



488



500



502

Servier- & Küchenhelfer kitchen & serving tools herramientas de cocina outils de cuisine



510



512



513

Hauben & Zubehör covers & accessories

NEUHEITEN 2019

NOVELTIES | NOVEDADES | NOUVEAUTÉS



Alle Neuheiten haben wir im Katalog mit dem „NEW“-Logo gekennzeichnet.



We have marked all novelties in the catalogue with the logo „NEW“.



Hemos marcado todas las novedades en este catálogo con el logotipo „NEW“.



Nous avons marqué tous les nouveautés dans le catalogue avec le logo „NEW“.



FRIDA | S. 190



COCONUT | S. 23



Getränkespender | S. 88



Glaskaraffen | S. 79



Buffetgestelle | S. 106

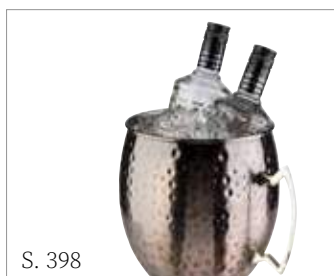

S. 398



S. 409



PINEAPPLE | S. 413



S. 401



IRON | S. 177



ARABESQUE | S. 168



GREEN BAMBOO | S. 172



Barartikel | ab S. 409



S. 309



S. 183



S. 345



BAMBOO | S. 170



DARK WAVE | S. 210



CIRCLE | S. 209



CRYSTAL | S. 408



BLUE OCEAN | S. 166



S. 298

DEUTSCH

Artikel	Seite
A	
Abfalleimer	456, 457
Abräumwagen	389
Abtropfmatte	430
Adapter / Zwischensteg	377
Allzweckgießer	305, 440, 441
Antirutschmatte	158
Apfel- / Zwiebelteiler	483
Aschenbecher	453-457
Aufstrichmesser	486
Ausgießer	303, 304, 434-436
Ausstellblech	493
Austernmesser	481
B	
Backblech	380
Backform	492
Backhandschuhe	373
Bain-Marie	359-362, 368
Bar-Caddy	431
Barlöffel	419
Barmaß	416-418
Barmatte	430
Becher	409-413
Becher Emaille	261
Behälter	85, 94, 141, 445
Bento Box	163
Beschriftungsetiketten	287
Beschriftungskarten	281
Besteckablage	252, 372
Besteckbehälter	28-29, 138-139, 142-143, 266, 277, 279-280, 333, 390-392, 394
Besteckständer	122, 142-143
Besteckständer Melamin	279, 391
Bestecktaschen	323
Beton	14, 139, 144, 182, 298, 313, 316-318, 405, 455
Bierglasträger	56, 407, 448
Blattschale Melamin	189, 212, 240-241
Bonleiste	498
Bonspieß	498
Bratenplatte	60
Brennflüssigkeit	373
Brennpastenbehälter Edelstahl	373
Brezel- oder Wurstständer	52, 114
Brotbox	124, 349
Brotkorb	326-349
Brotschneidebrett	124, 125
Brötchenschütze	329
Brötchenspender Edelstahl	136
Brottasche	342-343
Buffet Kühlset	26
Buffet Kühlset Edelstahl	73-74
Buffet-Set	18-19, 35, 39, 68
Buffetbrett	52
Buffetgestell	30, 106-109, 117, 338
Buffetleiter	22, 118-121
Buffetleiter Melamin	22
Buffetschilder	281, 285, 287
Buffetständer	15, 60, 102-104, 122, 127, 157, 165, 190, 347
Buffetständer Edelstahl	104, 165, 190, 347
Buffetständer Holz	15, 103
Buffetständer Metall	30, 60, 102-104, 157, 165, 190
Buffetvitrine	66-67, 69-72
Buffetvitrine Edelstahl	69-72
Butter- und Saucenwärmer	363
Butterdose	307
Butterservierer	271, 307
Bürste Bar	435

C	
Caddy	308-313
Cerealenspender	28, 29, 126, 127, 128
Cerealenspender Edelstahl	127, 128
Chafing Dish	352-365
Chafing Dish Rolltop	359-361, 364
Champagnerkühler	402, 403
Cocktailmesser	421, 480
D	
Dariorform	493
Deckel	19, 27, 76, 77, 121, 150, 160, 177, 187, 193, 194, 196, 205, 230, 233, 237, 243, 265, 270, 365, 366, 367, 376, 377, 378, 379, 382, 383, 511, 512
Deckel Edelstahl	356, 358
Dekoriermesser	482
Dip-Schälchen	243, 244
Dispenser	95
Dispenser Saft	28, 29, 31, 93, 95, 96, 97, 99
Dispenser Saft / Milch	31, 93, 95, 96
Display	105
Dosier- & Vorratsflasche	434
Dosierer Zucker	304-306, 440-442
Dosierpumpe	501
Dosierspender	501
Dressingtopf Edelstahl	64, 65
Dressingtopf Melamin	64, 65, 173
E	
Eier-Box	394
Eierbecher	253, 307
Eierkorb	343
Eierschneider	475
Eis-Kugel-Former	426
Eisbox	20, 425
Eiseimer	398, 424
Eisportionierer	474
Eisschaufel	427
Eiswaffel-Ständer	499
Eiszerkleinerer	426, 427
Emaille-Artikel	260-261, 307
Entkerner	481
Etagère	49, 110, 112-114, 228, 346
F	
Fadenschneider	479
Fast-Food Tablett	58, 395, 450
Fingerfood-Löffel	246-247
Flambierbrenner	483
Flaschenhalter Wein	407
Flaschenkühler	398, 401-402, 404-406, 409, 429
Flaschenöffner	429, 432, 433
Flaschenträger	407
Fleisch- / Gemüseplatte	32, 36
Folien-Abreibvorrichtung	498
Frischhaltedeckel	19, 27, 128, 129, 265, 512
G	
Gabel Fleisch	384, 385, 387, 463, 464, 467
Gabel Salat	387, 466, 469
Gebäckpalette	484
Gemüsemesser	482
Genusspalette	50
Getränkspender	84-91, 95, 431
Gewürzkasten	495
Gewürzmühle	288-293
Gewürzständer	303
Gläserschiene	407
Glasplatte	39, 55, 106
Glasumrand	427
Glocke	274, 455
Gourmetlöffel	273
GN Abtropfgitter	377, 378

GN Behälter	375-376, 378-379, 381-383
GN Besteckbehälter	138, 333, 390
GN Buffet Kühlset Edelstahl	37
GN Buffet-Set	35
GN Buffetgestell	24-25, 106, 338
GN Buffetleiter	118-119
GN Buffetplatte	53, 381
GN Buffetständer	190
GN Buffetvitrine Edelstahl	69, 71
GN Chafing Dish	352, 353, 355, 356, 359-362, 364, 365
GN Deckel	376, 378, 379, 382
GN Haube	16, 21, 26, 35, 69, 71, 73, 180, 326, 336, 337, 344, 368, 506-508
GN Konvektomatenblech	380
GN Korb	20, 344
GN Korb Metall	344
GN Korb Polypropylen	20, 326, 328, 333-334, 335, 336
GN Naturschieferplatte	25, 46, 47
GN Partyplatte	42, 43, 449
GN Rost	380
GN Schale Melamin	148, 149, 192, 195, 225, 230, 231
GN Servierbrett	50
GN Serviergestell	116
GN Servierplatte	53, 381
GN Tablett	17, 25, 30, 34, 53, 54, 55, 153, 158, 159, 166, 168, 171, 175, 176, 177, 180, 183, 190, 197, 199, 202, 203, 205, 210, 221, 225, 229, 233, 238, 239, 381
GN Tablett Edelstahl	30, 34
GN Tablett Melamin	17, 55, 153, 158, 159, 166, 168, 171, 175, 176, 177, 180, 183, 190, 197, 199, 202, 203, 205, 210, 221, 225, 229, 233, 238, 239
Gourmetgläser	263
Grapefruitmesser	482
H	
Haube	35, 37, 40, 41, 49, 155, 180, 206, 208, 245, 267, 268, 270, 236, 336, 337, 334, 506, 507-511
Haube Rolltop	20, 21, 39, 40, 48, 52, 66-74, 155, 245, 336, 337, 507, 509
Haube Rolltop Edelstahl	368
Heizelement	92, 360, 369, 371
Hobel	52
Holzbox	137, 310, 312
Hot Plate	370
Hummerbrecher	475
Hygieneschutz	52, 114, 136
I	
Induktionskochplatte	353-354, 356-358, 370
Isolierkanne	100-101
K	
Kaffeebecher	253
Kaffeedispenser Edelstahl	92, 369
Kaffeekanne	444
Kanne	80-82
Kanne Saft	81, 82
Karaffe Glas	78-82
Kartenhalter	281-285, 287
Kartoffelstampfer	477
Käsehobel	483
Käseglocken-Set	39, 40, 48, 52
Kaviarkühler	63, 270
Kellnermesser	433
Kerzenleuchter	314-316
Kesselbesen	477
Konditorplatte	63, 245, 270
Konferenzkühler	429

Korb	20, 327-337
Korb Edelstahl	165, 345, 346, 347
Korb Metall	344, 348, 349
Korb Polypropylen	20, 326-337
Korkenzieher	433
Kronkorkenschale	429
Küchentuchständer	499
Kugelausstecher	478
Kühlakku	18, 27, 66-77, 80, 85, 94, 429, 513
Kühlbox	16, 20, 25, 26, 53, 68, 69, 74
Kühlkaraffe	80
Kühlmanschette	406
Kühlschale	27, 75-77, 270
Kühltablett	16, 70, 72
L	
Likör- und Fondantrichter	490
Limettenpresse	422, 495
Löffel	173, 252, 384-387
Löffel Backen	489
Löffel Feinkost	475, 476
Löffel Fingerfood	222, 246-247
Löffel Frittieren	489
Löffel Gourmet	273
Löffel Salat	252, 387, 466, 469, 476
Löffel Saucen, Dressing	387, 470, 476
Löffel Spaghetti	386, 462, 465, 470
M	
Magnet-Messerhalter	498
Mandoline	490
Menage	238, 297-303
Messbecher	491
Messlöffelsatz	474
Metallrahmen für Induktionskochplatte	356-358, 370
Milchgießer/-kännchen	306, 442-444
Milchkännchen	443, 444
Milchkanne	97, 98
Minis	248-251
Moscow Mule Becher	398, 409-411
Mühle Pfeffer	288-293
Mühle Salz	288-293
Multi Rack Edelstahl	131-132
Multibox	137
Muscheltopf	265
Müslispender	28, 29, 126-129
N	
Naturschiefer	25, 46, 47, 48, 49, 51, 113, 114, 266, 267, 293
Naturschieferplatte	25, 46-49, 266-267, 293
O	
Orangenschäler	479
P	
Palmbattschale Melamin	240, 241
Parmesan Menage	302
Partyplatte	42-43
Passiermühle	488
Pastateller Melamin	239
Pendelschäler	480
Permanent-Ausgießer	435, 436
Pfanne	502, 503
Pfannenwender	387, 460, 466, 468
Pfeffermühle	288-293
Pinsel	495
Pitcher	82, 428
Pizzaform	503
Pizzaschaufel	494
Pizzaschneider	487
Platzsets	319-323
Platzteller	274
Pommes-Frites-Seiher	489
Portionsspender	443
Porzellan	353, 358

Q	
Quetschflasche	500, 501
R	
Rechnungstablett	59, 451
Reinigungsbürste für Ausgießer	435
Rezeptionsglocke	455
Rolltop-Set	39, 48
Rührglas	428
S	
Saftdispenser	28-29, 31, 93-97, 99
Saftkanne	80-82
Salzmühle	288-293
Sauciere	272
Schälchenspende	132, 133
Schale Beton	15, 23
Schale Edelstahl	37, 63, 270, 271, 346
Schale Emaille	260, 261, 307
Schale Melamin	27, 77, 83, 115, 122, 133, 148-151, 160, 167, 169, 170, 172, 174, 176, 177, 179, 181-184, 187, 189, 191-197, 208, 211 -218, 220, 223-233, 236, 237, 238, 240, 241-244, 248-251
Schaufel Eis	427
Schaufel Mehl	494
Schaufel Pommes	489
Schaumlöffel	386, 461, 465, 468
Schaumspesering	492
Schiefer	25, 46, 47, 48, 49, 51, 113, 114, 266, 267, 293
Schilder	283, 284, 512
Schlüsselschnur	438
Schneebesen	477
Schneidebrettständer	499
Schneidebrett	17, 124-125, 349, 421
Schöpflöffel	384-387, 461-465, 467
Sektkühler	398-403
Senftöpfchen	299
Service Tower	130
Servier- / Tortenplatte Edelstahl	41, 62, 268, 269
Servier- / Tortenplatte Melamin	245
Servierbrett	50-51
Serviergabel	387, 467
Serviergestell	111-113, 114-116, 264
Servierlöffel	252, 384-387, 461-466, 468
Servierpfanne	60, 502
Servierpfanne Schmiedeeisen	502
Serviertablett	41, 44 -45, 56, 57, 61, 268, 395, 446-449
Servierwagen	388, 389
Serviettenhalter	144-145
Serviettenringe	275
Serviettentaschen	323
Shaker	414, 415
Sieb	420, 421, 445, 488, 490
Snackholder	256-259
Snackpresenter	123
Sortierbox	393
Spachtel	486
Spargelschäler	478
Sparschäler	479
Speisenwärmer	363
Spießständer / Spieße	271
Spritzflasche	304, 435
Standascher	456, 457
Ständer	303, 400, 499
Ständer Wein- / Sektkühler	400
Staubkappen	438
Stielkasserolle	273
Stift	287
Stößel	423
Streichpalette	484
Streuer	294-296, 439, 489

Streuer Pfeffer	288-293, 296
Streuer Salz	288-293, 296
Superbox	24-25
Suppenkelle	469
Suppentopf	362, 366-367
Sushiboard Melamin	171, 172, 175, 176, 182, 185, 211, 212, 214, 219
System-Theke	383
T	
Table Caddy	141, 276, 308, 309, 311, 313, 391
Tablett	56-58, 60, 61, 115, 448-450
Tablett Edelstahl	17, 30, 32, 34, 36-38, 40, 43-45, 115, 239, 268, 446-447, 449
Tablett Fast Food	58, 395, 450
Tablett Holz	57-58, 154, 157, 309, 449, 450
Tablett Melamin	17, 55, 56, 61, 124, 152-153, 157-159, 166, 167, 168, 171, 175, 176, 177, 180, 182, 183, 185, 187, 190, 191, 193, 194, 197-214, 219-222, 225, 227, 229-231, 233-235, 239, 241, 251
Tasse Melamin	187, 253
Teebox	137
Teebrühsieb	83, 445
Teekanne ASIA	83, 442
Teigschaber / Abstecher	487
Teller Emaille	260
Teller Fingerfood	229, 253, 438
Teller Melamin	57, 161, 167, 169, 170, 175, 178, 186, 188, 211, 213, 219, 235, 250, 253
Thermo Tablett-Set	66-67
Thermo-Set	74
Tischrestebehälter	140-143, 277-279
Tischaufsteller	282, 286
Tischcaddy	308-313, 391
Tischkartenhalter	282-283, 285
Tischkrümelentferner	142, 275
Tischsets	319-322
Tortenheber	467, 470, 493
Tortenmesser	470
Tortenplatte	41, 48, 62, 63, 245, 268-269
Tortenring	492
Tortenteiler	493
Tourniermesser	482
Transportwagen	388, 389
Trenner	330
Tretbeutelhalter	457
Trinkbecher	87-91, 408
Trinkhalme	428, 431
Tropfenschale Melamin	88-89, 91
U	
Universalbox	136
Universalkanne	444, 491
Untersetzer Edelstahl	59, 275, 451
Untersetzer Kork, Holz	108, 502
Untersetzer Naturschiefer	48, 267, 293
Untertasse Melamin	187
V	
Vase	318
Verschluss	14, 79, 134 -135, 272, 277, 297-303, 306, 373, 437, 442, 452-453, 496
Verschluss Wein / Champagner	437
Vorratsglas	134-135, 496-497
W	
Wachspapier	50, 259
Wanne	18, 395, 401
Warenträger	42, 319
Wärme-Kies	373
Warnschild	513

Wasserbadschüssel	491
Wasserspender	91, 95
Weck Gläser	262-265, 267
Wein-Vakuum-Pumpe	438
Weinkühler	399-401, 403
Weinkühlerständer	400
Weinpumpe-Ersatzstopfen	438
Wender	385-387, 460, 462, 464-468, 484-487
Windascher	452-455
Windlicht	317
Z	
Zange	424, 426, 461, 471-474
Ziseliermesser	478, 479
Zitronenschnitzelpresse	83, 445
Zitruspresse	42, 495
Zitrusteiler	422
Zuckerdosierer	304-306, 440-442
Zuckerkugel	306, 443
Zuckerspender	306, 442
Zuckertüten-Box Edelstahl	443
Zutatenbehälter	431

buffet ladder melamine	22
buffet set	35, 39, 68
buffet signs	283
buffet stand 15, 30, 60, 102-104, 117, 122, 127, 157, 165, 190, 338, 347	
buffet stand stainless steel	104, 165, 190, 347
buffet stand wood	15, 103
buffet-board	52
burner holder stainless	373
butter and sauce pan warmer	363
butter dish	271, 307
C	
caddy	308-313
cake lifter	467, 470, 493
cake marker	493
cake plate melamine	245
cake plate stainless steel	41, 62, 268, 269
cake setting ring	492
cake slice	470
cake stand	41, 48, 62, 63, 245, 268-270
candle holder	314-316
canister with lid	134-135, 496-497
cap bowl	429
caviar cooler	63, 270
cereal dispenser	28, 29, 126-129
cereal dispenser stainless steel	127, 128
chafing dish	352-365
chafing dish rolltop	359-361, 364
champagne bowl	398-403
champagne saver	437
cheese dish	39, 40, 48, 52, 302
cheese slicer	483
chefs blow torch	483
chip bagger	489
chopping board	17, 124-125, 349, 421
clingfilm tear-off dispenser	498
cloche / dome cover	274, 455
coaster cork, wood	108, 502
coaster stainless steel	59, 275, 451
coffee cup	253
coffee dispenser stainless steel	92, 369
coffee pot	444
condiment container	495
confectionery funnel	490
conference bottle cooler	429
container	18, 94, 141, 389, 395, 401, 445
cool collar	406
cooler	18, 27, 66-77, 80, 85, 94, 429, 513
cooling bowl	27, 75-77, 270
cooling box	16, 20, 25, 26, 53, 68, 69, 73, 74
cooling carafe	80
cooling plates	16, 70, 72
corer	481
corkscrew	433
cornet stand	499
cover	19, 27, 76, 77, 121, 150, 160, 177, 187, 193, 194, 196, 205, 230, 233, 237, 243, 265, 270, 365, 366, 367, 376, 377, 378, 379, 382, 383, 511, 512
cover stainless steel	356, 358
crumber	142, 275
cup melamine	187, 253
curler	52
cutlery holder	14, 139, 144, 182, 298, 313, 316-318, 405, 455
cutlery bag	323
cutlery basket	122, 142-143

ENGLISH

item	page
A	
adapter	377
airtight cover	19, 27, 128, 129, 265, 512
apple/onion divider	483
ashtray	453-457
asparagus knife/peeler	478
B	
baking mittens	373
baking pan	492
baking sheet	380
bar caddy	431
bar knife	421, 480
bar spoon	419
barrel mug	409-413,
basket metal	344, 348, 349
basket polypropylene	20, 326-337
basket stainless steel	165, 345, 346, 347
beaker	261
beer rack	56, 407, 448
Bento Box	163
bill presenter	59, 451
bill rail	498
bill spike	498
bottle cooler	398, 401-402, 404-406, 409, 429
bottle fuel	373
bottle opener	429, 432, 433
bottle rack	407
bowl concrete	15, 23
bowl enamel	260, 261, 307
bowl holder	132, 133
bowl melamine	27, 77, 83, 115, 122, 133, 148-151, 160-251
bowl stainless steel	37, 63, 270, 271, 346
bread basket	342-343
bread cutting board	124, 125
breadbox	124, 349
buffet ladder	22, 118-121

cutlery basket melamine	391	GN tray stainless steel	30, 34,	oyster knife	481	squeeze bottle	304, 435, 500, 501
cutlery organizer	28-29, 138-139, 142-143, 266, 277, 279-280, 333, 390-392, 394	GN-container	375-376, 378-379, 381-383	P		stand for wine/champagne bowl	400
cutlery rest	252, 372	GN-convection oven trays	380	palm leaf melamine	240, 241	standing ashtray	456, 457
cutting board	124, 125	GN-drainer	377, 378	pan	60, 502, 503	strainer	420, 421, 445, 488, 490
cutting board rack	499	GN-lid	376, 378, 379, 382	paring knife	482	straws	428, 431
D		gourmet glasses	263	party spoon	222, 246-247, 273	sushiboard melamine	171, 172, 175, 176, 182, 185, 211, 219, 212, 214
dariol moulds	493	graduated jug	491	partytray	42-43	swivel peeler	480
decorating knife	482	grapefruit knife	482	pasta plate melamine	239	system-counter	383
decorator / zester	479	gravy boat	272	pastry spatula	484	T	
delicatessen spoon	475, 476	greaseproof paper squares	50, 259	pedal bin	457	table caddy	141, 276, 308, 309, 311, 313, 391
designation cards	281	H		peeler	479	table garbage bin	140-143, 277-279
dip bowl	243, 244	heating unit	92, 360, 369, 371	pepper mill	288-293	table stands	281-285, 287
dispenser	95	hot plate	370	pitcher	80-82, 428	tea-box	137
dispenser dosing	501	hygienic cover	52, 114, 136	pizza cutter	487	teapot ASIA	83, 442
dispenser service	443	I		pizza dish	503	thermo set	66, 67, 74
dispenser sugar	304-306, 440-442	ice ball former	426	pizza peel	494	tray	56-58, 60, 61, 115, 448-450
display	105	ice box	20, 425	placemat	319-323	tray melamine	17, 55, 56, 61, 124, 152-251
display tray	493	ice bucket	398, 424	plate enamel	260	tray stainless steel	17, 30, 32, 34, 36-38, 40, 43-45, 115, 239, 268, 446-447, 449
dosing pump	501	ice cream scoop	474	plate melamine	57, 161-253	tray wood	57-58, 154, 157, 309, 449, 450
dough scraper	487	ice crusher	426, 427	plate tray	274	turner	387, 460, 466, 468
dressing pot melamine	64, 65	ice scoop	427	plate warmer	363	U	
dressing pot stainless steel	64, 65	induction plate	353-354, 356-358, 370	porcelain plates	353, 358	universal box	136
dressing/sauce spoon	470, 476	J		pourer	305, 440, 441	V	
drinking cups	87-91, 408	jigger	416-418	pourer cleaning brush	435	vacuum jug	100-101
drinks dispenser	84-91, 95, 431	juice and milk dispenser	31, 93, 95, 96	pourers	303, 304, 434-436	W	
drip mat	430	juice dispenser	28-29, 31, 93, 95-97, 99	pouring container	434	waiter's corkscrew	433
drip tray	88-89, 91	Juice dispenser	28, 29, 31, 93, 95, 96, 97, 99	pretzel-/ sausage stand	52, 114	Weck glasses	262-265, 267
dust & fly cap	438	juice pitcher	81, 82	R		whisk	477
E		K		refrigerated buffet display	26	winebottle-stand	407
egg basket	343	key cord	438	refrigerator butter dish	307	woodbox	137, 310, 312
egg cutter	475	kitchen roll holder	499	ring bell	455	wrought-iron pan	502
egg holder	253, 307	L		roll / bun basket	329		
eggs box	394	labeling labels	287	roll dispenser stainless	136		
enamel	260-261, 307	labels	283, 284, 512	rolltop cover	20, 21, 39, 40, 48, 52, 66-74, 155, 245, 336, 337, 507, 509		
F		ladle	384-387, 461-465, 467	rolltop set	39, 40, 48, 52		
fingerfood plate	229, 253, 438	large whisk	477	rolltop-cover stainless steel	368		
flower vase	318	leaf melamine	189, 212, 240-241	S			
fork	387, 467	lime press	422, 495	salad fork	387, 466, 469		
frame for induction plate	356-358, 370	lobster cracker	475	salad spoon	252, 387, 466, 469, 476		
free flow pourer	435, 436	M		salt mill	288-293		
fry dripping tray	489	magnetic knife rack	498	sandwich knife	486		
G		mandolin	490	sauté pan / mini sauce pan	273		
glass carafe	78-82	masher	477	scoop	494		
glass plate	39, 55, 106	meat platter	60	scraper	486		
glass rack	407	meatfork	384, 385, 387, 463, 464, 467	service trower	130		
glass rimmer	427	melon baller	478	service trolley	388, 389		
GN 1/1 buffet set	35	menage	238, 297-303	servicing board	50-51		
GN 1/1 dispenser GN	138, 333, 390	milk dispenser	97, 98	servicing cup	256-259		
GN basket	20, 344	milk jug	306, 442-444	servicing spoon	252, 384-387, 461-466, 468		
GN basket metall	344	milk jung	443, 444	servicing stand	111-113, 114-116, 264, 303, 400, 499		
GN bowl, square melamine	148, 149, 192, 195, 225, 230, 231	mini bowl	248-251	servicing stand/rack	303		
GN buffet ladder	118-119	mixing glass	428	servicing trolley	388, 389		
GN buffet stand	24-25, 106, 190, 338	moscow mule barrel mug	398, 409-411	set measuring spoon	474		
GN Chafing Dish	352, 353, 355, 356, 359-362, 364, 365	moulin / sieve	488	shaker	414, 415		
GN cover	16, 21, 26, 35, 69, 71, 73, 180, 326, 336, 337, 344, 368, 506-508	mousse ring	492	shape sorter	393		
GN dish	53, 381	muddler	423	showcase	66-67, 69-72		
GN grid	380	multi rack stainless steel	131-132	showcase stainless steel	69-72		
GN basket polypropylene	20, 326 328, 333-336	multibox	137	skewer rack/skewer	271		
GN natural slate tray	25, 46, 47	mussel pot	265	skimmer	386, 461, 465, 468		
GN partytray	42, 43, 449	mustard glass	299	skimmer spoon	489		
GN refrigerated buffet display	69, 71	N		slate	25, 46, 47, 48, 49, 51, 113, 114, 266, 267, 293		
GN serving board	50	napkin bag	323	snack tray	58, 395, 450		
GN serving dish	53, 381	napkin holder	144-145	snackpresenter	123		
GN serving stand	116	napkin rings	275	snap mesh tea ball	83, 445		
GN tray	17, 25, 30, 34, 53, 54, 55, 153, 158, 159 -239, 381	natural slate tray	25, 46, 47, 48, 49, 51, 113, 114, 266, 267, 293	soup ladle	469		
GN tray melamine	17, 55, 153, 158-239	non slip mat	158	soup pot	362, 366-367		
		O		spaghetti spoon	386, 462, 465, 470		
		orange peeler	479	spatula	484		
				spice mill	288-293		
				spider spoon	489		
				spoon	173, 252, 384-387		

artículos **pág.**

A
 abre ostras 481
 abridor 429, 432, 433
 acumulador de frío 18, 27, 66-77, 80, 85, 94, 429, 513
 adaptador 377
 aro anti-goteo 88-89, 91
 aro de tarta 492
 aro redondo para semifríos 492
 azucarero 304-306, 440-442
 azucarero para bolsitas 443
B
 bajo plato 274
 bandeja 49, 110, 112-114, 228, 346
 bandeja 56-58, 60, 61, 115, 448-450
 bandeja acero inoxidable 17, 30, 32, 34, 36-38, 40, 43-45, 115, 239, 268, 446-447, 449
 bandeja autoservicio y snacks 58, 395, 450
 bandeja de pizarra natural 25, 46, 47, 48, 49, 51, 113, 114, 266, 267, 293
 bandeja de vidrio 39, 55, 106
 bandeja isotérmica 74
 bandeja madera 57-58, 154, 157, 309, 449, 450,
 bandeja melamina 17, 55, 56, 61, 124, 152-251
 bandeja para sushi melamina 171, 172, 175, 176, 182, 185, 211, 219, 212, 214
 bandeja party 42-43
 bandeja pastelera 380, 493
 bandeja tartas acero inoxidable 41, 62, 268, 269
 bandeja tartas melamina 245
 bandeja termo 66-67
 bandejas refrigeradas 16, 70, 72
 barra magnética para cuchillos 498
 batidor 477
 batidor gigante 477
 Bento Box 163
 bol refrigerado 27, 75-77, 270
 bolsa cubiertos 323
 bomba de salsa 501
 bomba de vacío para vino 438
 bote con tapa 134-135, 496-497
 bote dosificador flexible 500, 501
 bote vertedor universal 305, 440, 441
 botella „store & pour“ 434
 botella de combustible líquido 373
 botella exprimible 304, 435
C
 caballetes de mesa 282, 286
 cacerola 502, 503
 caddy de mesa 141, 276, 308, 309, 311, 313, 391
 caddy de mesa 308-313, 391
 cafetera 444
 caja de pan para buffet 124, 349
 caja dispensadora 136
 caja madera 137, 310, 312
 caja para huevos 394
 caja para té 137
 caja surtida 393
 cajón para cubiertos 28-29, 138-139, 142-143, 266, 279-280, 333, 390-392, 394
 calentador de mantequilla y salsa 363
 caliente platos 363
 campana 35, 37, 40, 41, 49, 155, 180, 206, 208, 245, 267, 268, 270, 236, 336, 337, 334, 506, 507-511

campana abatible 20, 21, 39, 40, 48, 52, 66-74, 155, 245, 336, 337, 507, 509
 campana esférica 274, 455
 campana rolltop 368
 candelabro 314-316
 carro de servicio 388, 389
 cazo para baño maría 491
 cazo recto bajo 273
 cenicero 453-457
 cenicero de pie 456, 457
 cepillo de limpieza para picos vertedores 435
 cesta acero inoxidable 165, 345, 346, 347
 cesta 20, 327-337
 cesta de huevos 343
 cesta metal 344, 348, 349
 cesta para bollos 329
 cesta para cubiertos 122, 142-143
 cesta para cubiertos melamina 391
 cesta polipropileno 20, 326-327
 Chafing Dish 352-365
 Chafing Dish Rolltop 359-361, 364
 coctelera 414, 415
 colador 420, 421, 445, 488, 490
 conjunto aperitivo 238, 297-303
 contenedor 389
 corta huevos 475
 corta pasta 487
 cortador de cítricos 422
 cortador de pizza 487
 cubeta 18, 395, 401
 cubierta higiénica antialiento 52, 114, 136
 cubiertos 14, 139, 144, 182, 298, 313, 316-318, 405, 455
 cubitera 20, 425
 cubitera isotérmica 398, 424
 cubitera para vino y cava 398-403
 cubo champañera 421, 480
 cuchara 173, 252, 384-387
 cuchara de espaguetis 386, 462, 465, 470
 cuchara gourmet 273, 475, 476
 cuchara para ensalada 252, 387, 466, 469, 476
 cuchara para helado 474
 cuchara para servir 252, 384-387, 461-466, 468
 cuchara party 222, 246-247
 cucharilla de cóctel 419
 cucharón 384-387, 461-465, 467
 cucharón de salsa/alino 470, 476
 cucharón de sopa 469
 cuchillo acanalador 482
 cuchillo curvado 482
 cuchillo de decoración cincelador 478, 479
 cuchillo mondador 482
 cuchillo para cóctel 421, 480
 cuchillo para pomelo 482
 cuchillo para untar 486
 cuenco acero inoxidable 37, 63, 270, 271, 346
 cuenco esmalte 260, 261, 307
 cuenco hormigón 15, 23
 cuenco melamina 27, 77, 83, 115, 122, 133, 148-151, 160-251
 cuenco mini 248-251
 cuenco para chapas 429
D
 dispensador 95
 dispensador de bebidas 84-91, 95, 431
 dispensador de bocadillos 123

dispensador de café acero inoxidable 92, 369
 dispensador de cereales 28, 29, 126-128
 dispensador de cereales acero inoxidable 127, 128
 dispensador de especias 431
 dispensador de film 498
 dispensador de leche 97, 98
 dispensador de panecillos acero inoxidable 136
 dispensador de salsa 501
 dispensador de zumo 28, 29, 31, 93, 95, 96, 97, 99
 dispensador en escalera 22, 118-121
 dispensador en escalera acero inoxidable 131-132
 dispensador en escalera melamina 22
 dispensador mixto zumo y leche 31, 93, 95, 96
 dispensador servicio 443
E
 embudo dosificador 490
 enfriador de botellas 398, 401-402, 404-406, 409, 429
 enfriador de caviar 63, 270
 enfriador múltiple 429
 escurridor de fritos 489
 esmalte 260-261, 307
 espátula 385-387, 460, 462, 464-468, 484-487
 espátula plancha 486
 especiero 495
 espumadera 386, 461, 465, 468
 espumadera para fritos 489
 esterilla antideslizante 158
 esterilla escurridora 430
 estructura o marco para placa de inducción 356-358, 370
 etiquetas 283, 284, 287, 512
 expositor 42, 105, 319
 expositor buffet 30, 106-109, 117, 338
 expositor buffet frío 16, 20, 25, 26, 53, 68, 69, 71, 73, 74
 expositor de buffet 15, 60, 102-104, 122, 127, 157, 165, 190, 347
 expositor de buffet acero inoxidable 104, 165, 190, 347
 expositor de buffet cromado 60, 102-104, 157, 165, 190
 expositor de buffet madera 15, 103
 exprimidor cítricos 42, 495
F
 flaneras 493
 florero 318
 fuente en forma de hoja de palmera melamina 240, 241
 fuente en forma de hoja melamina 189, 212, 240-241
 fuente para la mesa 60, 502
 fuente servicio 60
 funda de frío 406
G
 GN 1/1 dispensador de cubiertos 138, 333, 390
 GN 1/1 set de buffet 35
 GN bandeja 17, 25, 30, 34, 53, 54, 55, 153, 158-239, 381
 GN bandeja acero inoxidable 30, 34
 GN bandeja buffet 53, 381
 GN bandeja de pizarra natural 25, 46, 47
 GN bandeja melamina 17, 55, 153, 158-239
 GN bandeja party 42, 43, 449

GN campana 16, 21, 26, 35, 69, 71, 73, 180, 326, 336, 337, 344, 368, 506-508
 GN cesta 20, 344
 GN cesta metal 344
 GN cesta polypropileno 20, 326, 328, 333-334, 335, 336
 GN Chafing Dish 352, 353, 355, 356, 359-362, 364, 365
 GN cubeta 375-376, 378-379, 381-383
 GN cubeta para hornos de convección 380
 GN cuenco cuadrado melamina 148, 149, 192, 195, 225, 230, 231
 GN escurridor 377, 378
 GN rejilla 380
 GN soporte buffet 116
 GN soporte para buffet 190
 GN tabla de servir 50
 GN tapa 376, 378, 379, 382
 granulado térmico 373
H
 huevera 253, 307
I
 infusor de té, pinza con malla 83, 445
J
 jarra 80-82, 428
 jarra de leche 306, 442-444
 jarra de vidrio 78-82
 jarra de zumo 81, 82
 jarra fría 80
 jarra graduada 491
 jarra termo 100-101
 juego de cucharas medidoras 474
 lavero enrollable 438
M
 machacador 477
 mandolina 490
 manoplas de panadero 373
 mantelín 319-322
 mantequillera 271, 307
 mantequillera para nevera 307
 marcador de pasteles 493
 marco pastelero 492
 medidor jigger 431
 mejillonera 265
 molde de cubitos de hielo esféricos 426
 molde de pizza 503
 molinillo de pimienta 288-293
 molinillo de sal 288-293
 molino de grosellas 488
 molino de la especia 2 88-293
 mortero 423
 Moscow Mule taza 398, 409-411
 multibox 137
O
 olla para buffet 362, 366-367
 organizador de bar 431
P
 pajas 428, 431
 pala 494
 pala de hielo 427
 pala de pizza 494
 pala de tartas 467, 470, 493
 paleta pastelera 484
 panera 342-343
 papel alimenticio 50, 259
 papelera de sobremesa 140-143, 277-279
 pelador 479
 pelador de espárragos 478
 pelador de naranjas 479
 pelador reversible 480
 picadora de hielo 426, 427
 pie porta champañera/vino 400
 pie porta vino 400

piezas indicadores buffet	283
pinchanotas	498
pinza	424, 426, 461, 471-474
pinza bogavante	475
pinza exprime limón	83, 445
pizarra	25, 46, 47, 48, 49, 51, 113, 114, 266, 267, 293
placa caliente	370
placa de inducción	353-354, 356-358, 370
plato esmalte	260
plato melamina	57, 161, 167-170, 175, 178, 186, 188, 211, 213, 219, 235, 250, 253
plato para el aperitivo	229, 253, 438
plato para pasta melamina	239
porcelana	353, 358
porcionador de manzana / cebolla	483
porcionador de pastel	470
porta botellas	407
porta cuenta	59, 451
porta rollo de cocina	499
porta vasos de cerveza	56, 407, 448
porta-etiquetas	282-283, 285
portafichas	498
portatarjetas	281-285, 287
portavelas antiviento	317
posavasos acero inoxidable	59, 275, 451
posavasos corcho, madera	108, 502
posavasos pizarra natural	48, 267, 293
prensa de limón	422, 495
Q	
quemador	373
quesera parmesano	302
quita-rabillo	481
R	
rack de copas	407
rack dispensador para bols	132, 133
rebanador de queso	483
recipiente organizador	85, 94, 141, 445
recogedor para patatas fritas	489
recogemigas	142, 275
reposa cuchara	252, 372
resistencia	92, 360, 369, 371
ribeteador de vasos	427
rizador	52
S	
sacacorchos	433
sacacorchos de camarero	433
salsera	272
salsera acero inoxidable	64, 65
salsera melamina	64, 65
sartén forjada	502
service tower	130
servilletero	144-145
servilleteros	275
set de buffet	35, 39, 68
set de buffet refrigerado	26
set rolltop	39, 40, 48, 52
sistema para mostrador	383
soplete de cocina para flambear	483
soporte	303, 400, 499
soporte a pedal	457
soporte cucuruchos	499
soporte para botella de vino	407
soporte para brochetas	271
soporte para buffet	24-25, 106, 338
soporte para embutidos	52, 114
soporte para pastel	41, 48, 62, 63, 245, 268-270
soporte para tablas	499
soporte platos	111-116, 264
soporte salsas y condimentos	303
T	
tabla de servir	50-51

tabla para cortar	17, 124-125, 349, 421
tabla para el buffet	52
tapa	19, 27, 76, 77, 121, 150, 160, 177, 187, 193 194, 196, 205, 230, 233, 237, 243, 265, 270, 365-367, 376,-379, 382, 383, 511, 512
tapa de acero inoxidable	356, 358
tapa hermética	19, 27, 128, 129, 265, 512
tapete escurridor	430
tapón antipolvo	438
tapón vertedor	437
tarjetas	281
tarros gourmet	263
taza	409-413
taza de café	253
taza melamina	187, 253
tenedor de carne	384, 385, 387, 463, 464, 467
tenedor de servicio	387, 467
tenedor de servicio para ensalada	387, 466, 469
tetera ASIA	83, 442
timbre	455
V	
vaciador de melón redondo	478
vaso coctelero	261
vaso mezclador vertedor	428
vaso para servir	256-259
vasos	87-91, 408
vasos mostaza	299
vertedor continuos	435, 436
vertedores	303, 304, 434-436
vitrina de buffet	66-67, 69-72
W	
Weck-botellas	262-265, 267

FRANÇAIS

item	pág.
A	
accumulateur de froid	18, 27, 66-77, 80, 85, 94, 429, 513
adaptateur	377
anneau coupe-gouttes	88-89, 91
anneaux à serviettes	275
ardoise	25, 46, 47, 48, 49, 51, 113, 114, 266, 267, 293
assiette creuse mélamine	239
assiette de présentation	274
assiette émail	260
assiette mélamine	57, 161, 167, 169, 170, 175, 178, 186, 188, 211, 213, 219, 235, 250, 253
assiette pour apéritif	229, 253, 438
B	
bac	18, 395, 401
bac à couverts	28-29, 138-139, 142-143, 266, 277, 279-280, 333, 390-392, 394
barre aimantée pour couteaux	498
barre porte-bons	498
base bois	137, 310, 312
Bento Box	163
beurrier	271, 307
boîte à beurre pour le frigo	307
boîte à épices ou ingrédients	495
boîte à fruits et ingrédients	431
boîte à œufs	394
boîte à pain pour le buffet	124, 349
boîte à thés et infusions	137
boîte de tri	393
boîte distributrice	136
bol béton	15, 23
bol couvercle inox	37, 63, 270, 271, 346
bol émail	260, 261, 307
bol mélamine	27, 77, 83, 115, 122, 133, 148-151, 160-251
bol mélangeur	261
bol mini	248-251
bol récupérateur de capsules	429
bol réfrigéré	27, 75-77, 270
bordeur à verres	427
bouchon anti-poussières et anti-insectes	438
bouchon verseur	437
bouchons verseurs	303, 304, 434-436
boule à thé avec pince	83, 445
bouteille „store & pour“	434
bouteille de combustible liquide	37
bouteille isotherme	100-101
bouteille verseuse souple	500, 501
brosse lave-bouchons doseurs	435
broyeur à glaçons	426, 427
brûleur	373
C	
caddy de table	141, 276, 308, 309, 311, 313, 391
cadre support inox pour plaque induction	356-358, 370
caisson thermo	66-67
carafe en verre	78-82
casserole	502, 503
casserole à moules	265
cendrier	453-457
cendrier sur pied	456, 457
cercle à gâteaux	492
cercle à mousse rond	492
Chafing Dish	352-365
Chafing Dish Rolltop	359-361, 364
chalumbeau e cuisine	483
chandelier	314-316

chariot de service	388, 389
chauffe-plat	363
chevalets de table	282, 286
cloche	35, 37, 40, 41, 49, 155, 180, 206, 208, 245, 267, 268, 270, 236, 336, 337, 334, 506, 507-511
cloche basculante	20, 21, 39, 40, 48, 52, 66-74, 155, 245, 336, 337, 507, 509
cloche demi-sphère	274, 455
cloche rolltop	368
coquetier	253, 307
corbeille	20, 327-337, 342-343
corbeille à petits pains	329
corbeille acier inox	165, 345, 346, 347
corbeille métal	344, 348, 349
corbeille polypropylène	20, 326-327
coupe-agrumes	422
coupe-œufs	475
coupe-pâte	487
coupe-pizza	487
coupe-pomme ou oignon en quartiers	483
couteau à huîtres	481
couteau à pamplemousse	482
couteau à tarte	470
couteau à tartiner	486
couteau cannelé	482
couteau cocktail	421, 480
couteau d'office bec d'oiseau	482
couteau d'office	482
couteau tranche-fromage	483
couteau zesteur	479
couteau zesteur cannelé	478, 479
couvercle	19, 27, 76, 77, 121, 150, 160, 177, 187, 193 194, 196, 205, 230, 233, 237, 243, 265, 270, 365, 366, 367, 376, 377, 378, 379, 382, 383, 511, 512
couvercle acier inox	356, 358
couvercle hermétique	19, 27, 128, 129, 265, 512
couverts	14, 139, 144, 182, 298, 313, 316-318, 405, 455
cuillère	173, 252, 384-387
cuillère à cocktail	419
cuillère à glace	474
cuillère à salade	252, 387, 466, 469, 476
cuillère à sauce	470, 476
cuillère à spaghettis	386, 462, 465, 470
cuillère de service	252, 384-387, 461-466, 468
cuillère gourmet	273, 475, 476
cuillère party	222, 246-247
D	
décapsulateur	429, 432, 433
dérouleur de film	498
distributeur de petits pains acier inox	136
disque à marquer les parts	493
distributeur	95
distributeur à jus	28-29, 31, 93, 95-97, 99
distributeur à jus de fruit	28, 29, 31, 93, 95, 96, 97, 99
distributeur à lait	97, 98
distributeur de boissons	84-91, 95, 431
distributeur de café acier inox	92, 369
distributeur de céréales	28, 29, 126-128
distributeur de céréales acero inox	127, 128
distributeur mixte à lait et à jus de fruit	31, 93, 95, 96

doseur à sauce	501	multibox	137	porte verres à bière	56, 407, 448	sucrier	304-306, 440-442
E		O		porte-addition	59, 451	support	303, 400, 499
écumoire	386, 461, 465, 468	organisateur „bar caddy“	431	porte-bols	132, 133	support à bretzel ou à saucissons	
écumoire à friture	489	P		porte-bougies anti-vent	317		52, 114
égouttoir à couverts	122, 142-143	pailles	428, 431	porte-bouteille	407	support à cornets	499
égouttoir à couverts mélamine	391	panier à œufs	343	porte-cartes	281-285, 287	support multiple acier inox	131-132
égouttoir à friture	489	papier alimentaire	50, 259	porte-clés avec câble à enroulement		support pour brochettes	271
email	260-261, 307	pare-haleine	52, 114, 136		438	système-comptoir	383
entonnoir à piston	490	peleur	479	porte-étiquettes à pince	282-283, 285	T	
équeuteur	481	peleur à asperges	478	porte-sachets de sucre	443	tamis	420, 421, 445, 488, 490
étagère	49, 110, 112-114, 228, 346	peleur à oranges	479	porte-serviettes	144-145	tapis antidérapant	158
étiquettes	281, 287	pelle à farine	494	pot à sauce acier inox	64, 65	tapis de bar	430
F		pelle à frites	489	pot à sauce mélamine	64, 65	tapis égouttoir	430
flacon pulvérisateur	304, 435	pelle à gâteau	467, 470, 493	pot en verre avec couvercle	134-135, 496-497	tasse à café	253
forme à gateaux	492	pelle à glaçons	427	pot verseur universel	305, 440, 441	tasse mélamine	187, 253
fouet	477	pelle à pizza	494	poubelle à pédale	457	théière ASIA	83, 442
fouet géant	477	petits chevaux de buffet	283	poubelle de table	140-143, 277-279	tire-bouchons	433
fourchette à viande	384, 385, 387, 463, 464, 467	pichet	80-82, 428	présentoir	42, 105, 319	tour de service	130
fourchette de service	387, 467	pichet à café	444	présentoir à assiettes	111-113, 114-116, 264	V	
fourchette de service pour la salade	387, 466, 469	pichet à eau ou lait	306, 442-444	présentoir à gâteaux	41, 48, 62, 63, 245, 268-270	vase soliflor	318
frisette	52	pichet à jus de fruit	81, 82	présentoir à sandwiches	123	verre mélangeur	428
G		pichet gradué	491	présentoir buffet	15, 24, 25, 60, 102-104, 106, 122, 127, 157, 165, 190, 338, 347	verres à moutarde	299
gants de boulanger	373	pichet rafraîchisseur	80	présentoir buffet acier inox		verres gourmet	263
GN 1/1 bac à couverts	138, 333, 390	piéd pour seau à champagne/vin	400		104, 165, 190, 347	verseurs continus	435, 436
GN 1/1 set catering: plateau + cloche	35	piéd pour seau à vin	400	présentoir buffet bois	15, 103	vitrine de buffet	66-67, 69-72
GN bac	375-376, 378-379, 381-383	pilon	477	présentoir buffet chromé	60, 102-104, 157, 165, 190	W	
GN bac pour fours à convection	380	pilon muddler	423	présentoir buffet de froid	16, 20, 25, 26, 53, 68, 69	Weck-bouteilles	262-265, 267
GN bol carré mélamine	148, 149, 192, 195, 225, 230, 231	pince	424, 426, 461, 471-474	présentoir buffet en escalier	22, 118-121		
GN Chafing Dish	352, 353, 355, 356, 359-362, 364, 365	pince à homard	475	présentoir buffet en escalier mélamine	22		
GN cloche	16, 21, 26, 35, 69, 71, 73, 180, 326, 336, 337, 344, 368, 506-508	pince presse citron	83, 445	présentoir buffet froid	26		
GN corbeille	20, 344	piques-bons	498	présentoir pour le buffet	35, 39, 68		
GN corbeille métal	344	planche à découper	17, 124-125, 349, 421	présentoir service	443		
GN corbeille polypropylène	20, 326, 328, 333-334, 335, 336	planche à découper buffet	52	presse citron	422, 495		
GN couvercle	376, 378, 379, 382	planche de service	50-51	presse-groseilles	488		
GN égouttoir	377, 378	plaque à induction	353-354, 356-358, 370	R			
GN grille	380	plaque à pâtisserie	380, 493	rack porte-verres	407		
GN planche de service	50	plaque chaude	370	rack pour planches à découper	499		
GN plat ardoise naturelle	25, 46, 47	plat à gâteau acier inox	41, 62, 268, 269	rafraîchisseur	429		
GN plat buffet	53, 381	plat à gâteau mélamine	245	rafraîchisseur de bouteilles	398, 401-402, 404-406, 409, 429		
GN plateau	17, 25, 30, 34, 53, 54, 55, 153, 158-239, 381	plat à sauter	273	rafraîchisseur de caviar	63, 270		
GN plateau acier inox	30, 34	plat ardoise naturelle	25, 46, 47, 48, 49, 51, 113, 114, 266, 267, 293	ramasse-miettes	142, 275		
GN plateau mélamine	17, 55, 153, 158, 159, 166, 168-239	plat de service	60	réchaud à beurre et sauce	363		
GN plateau party	42, 43, 449	plat pour la table	60, 502	réipient	389		
GN présentoir buffet	190	plateau	56-58, 60, 61, 115, 448-450	réipient bain-marie	491		
GN support buffet	116	plateau bois	57-58, 154, 157, 309, 449, 450,	réipient de table	85, 94, 141, 445		
gobelet	87-91, 408-413	plateau buffet froid	69, 71	résistance	92, 360, 369, 371		
gobelet à apéritif	256-259	plateau couvercle inox	17, 30, 32, 34, 36-38, 40, 43-45, 115, 239, 268, 446-447, 449	rouleur papier essuie-tout	499		
gravier thermique	373	plateau feuille de palme mélamine		S			
H		plateau feuille mélamine	189, 212, 240-241	saucière	272		
housse isotherme	406	plateau mélamine	17, 55, 56, 61, 124, 152-251	seau à champagne	421, 480		
J		plateau party	42-43	seau à glaçons	20, 425		
jeu de cuillère à mesure	474	plateau self-service et snacks	58, 395, 450	seau à glaçons isothermique	398, 424		
louche	384-387, 461-465, 467	plateau sous-verre acier inox	59, 275, 451	seau à vin ou champagne	398-403		
louche de service	469	plateau sushi mélamine	171, 172, 175, 176, 182, 185, 211, 219, 212, 214	service à parmesan	302		
M		plateau verre	39, 55, 106	set apéritif	238, 297-303		
mandoline	490	plateaux réfrigérés	16, 70, 72	set cloche à fromage	39, 40, 48, 52		
marmite de buffet	362, 366-367	plucheur droitier/gaucher	480	set de table	319-323		
mesure jigger	431	pochette couverts	323	set thermo	74		
Moscow Mule gobelet	398, 409-411	poêle à frire forgée	502	shaker	414, 415		
moule à boule ronde simple	478	pompe à sauce	501	sonnette	455		
moule à glaçons en boules	426	pompe à vide pour le vin	438	soucoupes ardoise naturelle	48, 267, 293		
moule à pizza	503	porcelaine	353, 358	soucoupes liège, bois	108, 502		
moules à flan	493	porte condiments et sauces	303	spatule	387, 460, 466, 468, 484		
moulin à épices	288-293			spatule coudée spéciale grill	486		
moulin à poivre	288-293			spatule pâtissière	484		
moulin à sel	288-299						





Buffet & Display

Tablets
Karaffen
Dispenser
Buffetständer
Isolierkannen

bandejas
jarras
dispensadores
soportes para buffet
jarras termo

trays
carafes
dispensers
buffet stands
vacuum jugs

plateaux
carafes
distributeurs
présentoires buffet
bouteilles isotherme

ELEMENT



Bekannt aus dem Bereich der Inneneinrichtung, lässt sich Beton nun auch im Buffetbereich stilvoll einsetzen. ELEMENT bietet drei unterschiedliche Präsentationsschalen, die sehr ansprechend in jede rustikale, natürliche aber auch urbane Buffetlandschaft integriert werden kann.

Known from the interior design sector, concrete can now also be used stylishly in the buffet area. ELEMENT offers three different presentation bowls, which can be very attractively integrated into any rustic, natural but also urban buffet landscape.

Conocido del sector de diseño interior, ahora el homigón también puede ser utilizado en el área del buffet. ELEMENT ofrece tres cuencos de presentación diferentes, que pueden ser integrados atractivamente en cualquier paisaje de buffet rústico, natural, pero también urbano.

Connu dans le domaine du design d'intérieur, le béton peut désormais être utilisé avec élégance dans la zone du buffet. ELEMENT offre trois bols de présentation différents, qui peuvent être intégré très attrayante dans n'importe quel paysage de buffet rustique, naturel, mais aussi urbain.





Schale „ELEMENT“

bowl
cuenco
bol



	Ø cm	↑ cm	ltr.	€
30000	22,0	6,0 / 10,5	1,1	18,00



Schale „ELEMENT“

bowl
cuenco
bol



	Ø cm	↑ cm	ltr.	€
30001	26,0	7,5 / 13,0	1,7	21,00



Schale „ELEMENT“

bowl
cuenco
bol



	Ø cm	↑ cm	ltr.	€
30002	29,5	8,5 / 14,5	2,5	24,00



Buffetständer

buffet stand
expositor de buffet
présentoir buffet



Akazienholz
acacia wood
madera de acacia
bois d'acacia

	Ø cm	↑ cm	€
33255	15	10	14,00



Buffetständer

buffet stand
expositor de buffet
présentoir buffet



Akazienholz
acacia wood
madera de acacia
bois d'acacia

	Ø cm	↑ cm	€
33256	25	15	17,00

FRAMES



Die reduzierte, archetypische Formsprache von FRAMES nimmt sich elegant zurück und lässt damit viel Raum für die Inszenierung der Buffet-Speisen. Ein scheinbarer Widerspruch löst sich auf: das Design ist zeitgemäß und zeitlos zugleich.

Design in detail – The classic minimalist visual style of FRAMES is elegantly understated, leaving plenty of potential for creating appealing buffet arrangements. Its design transcends what at first seems to be an irreconcilable paradox, being at once both timeless and highly contemporary.



Kühltablets SET 1 „FRAMES“

cooling plates
bandejas refrigeradas
plateaux réfrigérés



GN 1/1 Basiselement, GN 1/1 Edelstahl Tablett 18/10, Kühlakku

GN 1/1 base element, GN 1/1 stainless steel platter 18/10, cooler

elemento básico GN 1/1, bandeja GN 1/1 de acero inoxidable 18/10, acumulador de frío

élément de base GN 1/1, plateau GN 1/1 inox 18/10, accumulateur de froid

	cm	↑ cm	GN	Farbe / Colour		€
12940	53,0 x 32,5	8,5	1/1	stainless steel		224,00
14940	53,0 x 32,5	8,5	1/1	wenge wood		226,00
13940	53,0 x 32,5	8,5	1/1	ahorn wood		226,00



Kühltablets SET 2 „FRAMES“

cooling plates
bandejas refrigeradas
plateaux réfrigérés



GN 1/1 Basiselement, GN 1/1 Edelstahl Tablett 18/10, Rolltop-Haube, Kühlakku

GN 1/1 base element, GN 1/1 stainless steel platter, rolltop cover, cooler

elemento básico GN 1/1, bandeja GN 1/1 de acero inoxidable 18/10, campana rolltop, acumulador de frío

élément de base GN 1/1, plateau GN 1/1 inox 18/10, cloche rolltop, accumulateur de froid

	cm	↑ cm	GN	Farbe / Colour		€
12941	53,0 x 32,5	27,5	1/1	stainless steel		286,00
14941	53,0 x 32,5	27,5	1/1	wenge wood		289,00
13941	53,0 x 32,5	27,5	1/1	ahorn wood		289,00

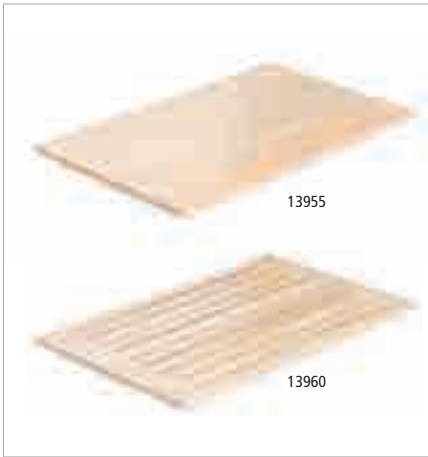

Schneidebrett „FRAMES“

chopping Board
tabla para cortar
planche à découper



Ahorn, massiv
ahorn wood, solid
madera de arce, masivo
bois d'érable, massif

	cm			€
13955	53,0 x 32,5	1/1		51,50
13960	53,0 x 32,5	1/1	gerillt	55,60



Schneidebrett „FRAMES“

chopping Board
tabla para cortar
planche à découper



	cm	GN		€
17910	53,0 x 32,5	1/1		54,00



GN Edelstahl Tablett „FRAMES“

GN stainless steel platter
GN bandeja acero inoxidable
GN plateau acier inox



	cm	GN		€
11119	53,0 x 32,5	1/1		28,00
11118	32,5 x 26,5	1/2		16,00

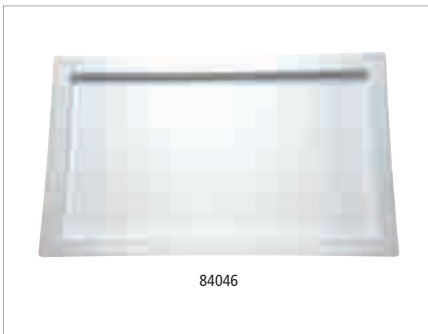

GN Tablett „FRAMES“

GN tray
GN bandeja
GN plateau



	cm	↑ cm	GN	€
84046	53,0 x 32,5	2	1/1	26,00
84047	32,5 x 26,5	2	1/2	14,20
84048	32,5 x 17,6	2	1/3	10,00



GN Tablett „FRAMES“

GN tray
GN bandeja
GN plateau



	cm	↑ cm	GN	€
82355	53,0 x 32,5	2	1/1	33,00
82356	32,5 x 26,5	2	1/2	19,00
82357	32,5 x 17,6	2	1/3	16,00

Buffet & Display



Bowl Box L „FRAMES“



eckig, isolierendes Basiselement mit Melaminschalen (weiß, Ø 23 cm)
 square, insulating base element with melamine bowl (white, Ø 23 cm)
 cuadrado, elemento básico aislante con cuencos de melamina (en blanco, ø 23 cm)
 carré, élément de base isolant avec bols en melamine (en blanc, ø 23 cm)

	cm	↑ cm	Farbe / Colour	€
12925	26,5 x 26,5	8,5	stainless steel	100,00
14925	26,5 x 26,5	8,5	wenge wood	112,00
13925	26,5 x 26,5	8,5	ahorn wood	112,00



Bowl Box S „FRAMES“



eckig, isolierendes Basiselement mit Melaminschalen (weiß, Ø 14 cm)
 square, insulating base element with melamine bowl (white, ø 14 cm)
 cuadrado, elemento básico aislante con cuencos de melamina (en blanco, ø 14 cm)
 carré, élément de base isolant avec bols en melamine (en blanc, ø 14 cm)

	cm	↑ cm	Farbe / Colour	€
12920	17,4 x 17,4	6,0	stainless steel	51,00
14920	17,4 x 17,4	6,0	wenge wood	62,00
13920	17,4 x 17,4	6,0	ahorn wood	62,00



Schale „CASUAL MAXI“ „FRAMES“



bowl
 cuenco
 bol

	Ø cm	↑ cm	litr.	Farbe / Colour	€
83700	14	6,5	0,50		3,80
83702	23	10,5	2,50		9,00
83701	14	6,5	0,50		3,80
83703	23	10,5	2,50		9,00



Kühllakku

cooler
 acumulador de frío
 accumulateur de froid



	cm	€
10782	41 x 21	14,20



GN Polystyrolwanne „FRAMES“



GN polystyrene tray
 GN bandeja poliestireno
 GN plateau polystyrène

	cm	€
17922	53,0 x 32,5	55,20



Bowl Box S „FRAMES“



rund, isolierendes Basiselement mit Melaminschalen (weiß, Ø 14 cm)
 round, insulating base element with melamine bowl (white, Ø 14 cm)
 redondo, elemento básico aislante con cuencos de melamina (en blanco, ø 14)
 rond, élément de base isolant avec bols en melamine (en blanc, ø 14 cm)

	Ø cm	↑ cm	Farbe / Colour	€
12910	17,4	6,0	stainless steel	49,00
14910	17,4	6,0	wenge wood	60,00
13910	17,4	6,0	ahorn wood	60,00



Bowl Box L „FRAMES“



rund, isolierendes Basiselement mit Melaminschalen (weiß, Ø 23 cm)
 round, insulating base element with melamine bowl (white, Ø 23 cm)
 redondo, elemento básico aislante con cuencos de melamina (en blanco, ø 23 cm)
 rond, élément de base isolant avec bols en melamine (en blanc, ø 23 cm)

	Ø cm	↑ cm	Farbe / Colour	€
12915	26,5	8,5	stainless steel	99,00
14915	26,5	8,5	wenge wood	112,00
13915	26,5	8,5	ahorn wood	112,00



Schale
 bowl
 cuenco
 bol



	Ø cm	↑ cm	€
11865	14	3,5	2,20
11875	23	10,5	4,20



Frischhaltedeckel
 airtight cover
 tapa hermética
 couvercle hermétique



	Ø cm	€
10890	14	10,50
10887	23	19,00

Buffet & Display



Korb „GN LINE“

GN basket
GN cesta
GN corbeille



stabile Ausführung mit Edelstahldraht im Rand zur Stabilisierung

very solid with stainless steel wire frame to stabilize the basket

muy resistente con refuerzo de alambre inox

très résistante avec son fil de renfort inox

	cm	↑ cm	GN	€
40291	53,0 x 32,5	6,5	1/1	18,50
40290	32,5 x 26,5	6,5	1/2	11,50
40293	53,0 x 32,5	10,0	1/1	23,00
40292	32,5 x 26,5	10,0	1/2	13,80



Buffetkorb

buffet basket
cesta de buffet
corbeille de buffet



Polyrattan, mit Haubenschiene (ohne Haube)

polyrattan, with frame to fix the (without cover)

polyrattan, con fijación para campana (sin campana)

polyrattan, avec fixation pour la cloche (sans cloche)

	Ø cm	↑ cm	€
40295	40	12,5	19,80



GN Basket L

GN basket L
cesta GN L
corbeille GN L



Polyrattan, mit Haubenschiene (ohne Haube)

polyrattan, with frame to fix the (without cover)

polyrattan, con fijación para campana (sin campana)

polyrattan, avec fixation pour la cloche (sans cloche)

	cm	↑ cm	€
40294	56,5 x 36,0	10,0	28,70



Rolltop-Haube

rolltop cover
campana abatible
cloche basculante



	Ø cm	↑ cm	€
18389	38	20	21,00



Eisbox „FRAMES“

ice box
bandeja hielo para el bufé
caisse à glaçons pour le buffet

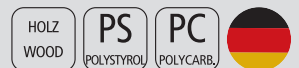

3-teilig: 1 Basiselement Wenge + 1 Polystyrolwanne + 1 Tropfgitter

3 pcs. set: 1 box wenge + 1 plastic deep tray + 1 drainer plate

set 3 piezas: 1 cajón color wengué, 1 cubeta plástico, 1 rejilla

set 3 éléments: caisson couleur wengué, 1 bac plastique, 1 plaque perforée

	cm	↑ cm	GN	Farbe / Colour	€
14970	53 x 32,5	12,5	1/1		179,00



GN 1/1 Rolltop-Haube
 GN 1/1 rolltop cover
 GN 1/1 campana abatible
 GN 1/1 cloche basculante



	cm	↑ cm	GN	€
11018	53,0 x 32,5	17	1/1	62,00



Besteck- / Universal-Box, 2-teilig „FRAMES“
 cutlery tray, 2 pcs.
 cubertero o cajón multi-usos, 2pz.
 caisson à couverts ou multi-usages



Buche massiv, Wenge, 4 Fächer, inklusive herausnehmbaren Einsatz
 wood wenge, 4 compartments
 madera de haya maciza, color wengué, 4 compartimentos, separadores removibles
 hêtre massif, couleur wengé, 4 compartiments, séparateurs amovibles

	cm	↑ cm	Farbe / Colour	€
14956	53 x 32,5	11		174,00

Einsatz für GN 1/1 „FRAMES“ / insert for GN1/1 „FRAMES“ / interior para GN1/1 „FRAMES“ / insert pour GN1/1 „FRAMES“

	cm	↑ cm	Farbe / Colour	€
14954	48,5 x 28	8		40,00

14954
Einsatz



vielseitig einsetzbar für
alle GN 1/1 Artikel

Gestell für GN 1/1 „FRAMES“
 serving stand
 cubertero o cajón multi-usos
 caisson à couverts ou multi-usages



Buche massiv, Wenge
 wood, wenge
 madera de haya maciza, wengué
 hêtre massif, wengé

	cm	↑ cm	Farbe / Colour	€
14953	57,5 x 27,5	22		76,00



84047
GN 1/2

84047
GN 1/2

14942
passendes GN 1/1 Basis-
Element

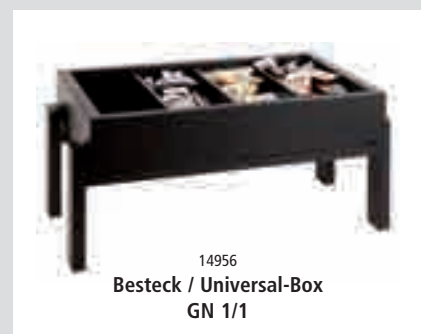

14956
Besteck / Universal-Box
GN 1/1



Buffetleiter Set „FRAMES“

bowl stand set
set dispensador en escalera
set présentoir buffet en escalier



14-teilig: Buffetleiter für 5 Schalen (ø 23cm):
5 Melaminschalen (weiß) mit 5 Deckeln,
2 Ringe (doppelt), 1 Ring (einzeln)

14 pcs.:
bowl stand for 5 bowls (ø 23 cm):
5 melamine bowls (white) with 5 lids, 2 rings
(double), 1 ring (single)

set de 14:
dispensador en escalera para 5 cuencos (ø 23 cm):
5 cuencos de melamina (en blanco) con 5 tapas,
2 aros (doble), 1 aro (sencillo)

set de 14:
présentoir buffet en escalier pour 5 bols (ø 23 cm):
5 bols en melamine (en blanc) avec 5 couvercles,
2 cercles (double), 1 cercle (simple)

	cm	↑ cm	€
11398	50,0 x 40,0	65,0	190,00



Buffetleiter Set „FRAMES“

bowl stand set
set dispensador en escalera
set présentoir buffet en escalier



12-teilig: Buffetleiter für 7 Schalen (ø 23cm):
7 Melaminschalen (weiß), 3 Ringe (doppelt),
1 Ring (einzeln)

12 pcs.:
bowl stand for 7 bowls (ø 23 cm):
7 melamine bowls (white), 3 rings (double),
1 ring (single)

set de 12:
dispensador en escalera para 7 cuencos (ø 23 cm):
7 cuencos de melamina (en blanco), 3 aros (doble),
1 aro (sencillo)

set de 12:
présentoir buffet en escalier pour 7 bols (ø 23 cm):
7 bols en melamine (en blanc), 3 cercles (double),
1 cercle (simple)

	cm	↑ cm	€
11399	50,0 x 40,0	65,0	160,00



Einzelteile / spare parts / piezas sueltas / pièces détachées

Buffetleiter / buffet ladder / dispensador en escalera / présentoir buffet en escalier

	€
11395	83,00

Einzelring / single ring / aro sencillo / cercle simple

	€
11396	11,00

Doppelring / double ring / aro doble / cercle double

	€
11397	21,50

NEW COCONUT



Schale „COCONUT“
bowl
cuenco
bol



	Ø cm	↑ cm	ltr.	€
30020	18	9,5	1,0	19,00



Schale „COCONUT“
bowl
cuenco
bol



	Ø cm	↑ cm	ltr.	€
30021	23	12,5	2,2	24,00



möbelschonende Unterseite
furniture-friendly underside

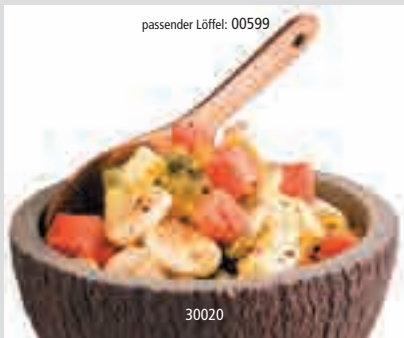

passender Löffel: 00599

30020

SUPERBOX



Die stapelbaren Wendeboxen lassen sich rutschfest stapeln und mit flachen GN Platten verbinden und einzeln nutzen. Individuell können Buffetlandschaften gebaut werden.

The stackable and non-slip reversible boxes can be connected to flat GN trays and can also be used individually. Different and individual buffet sceneries can be built up.

Las cajas girable y apilables son antideslizantes y se pueden conectar con bandejas planas GN o utilizar individualmente. Se pueden construir diferentes paisajes de buffet muy individuales.

Les boîtes de tournage empilables sont antiglissantes et peuvent être connectées avec des plateaux plats GN ou utilisées individuellement. Des paysages de buffet très personnalisés peuvent être construits.



GN 1/1 „SUPERBOX“

Akazienholz / acacia wood / madera de acacia / bois d'acacia



	cm	↑ cm	Farbe / Colour	€
11620	55,5 x 35,0	10,5		33,00
11626	55,5 x 35,0	10,5		33,00



GN 2/4 „SUPERBOX“

Akazienholz / acacia wood / madera de acacia / bois d'acacia



	cm	↑ cm	Farbe / Colour	€
11623	55,5 x 18,5	10,5		27,00
11629	55,5 x 18,5	10,5		27,00



GN 1/2 „SUPERBOX“

Akazienholz / acacia wood / madera de acacia / bois d'acacia



	cm	↑ cm	Farbe / Colour	€
11621	35 x 29	10,5		21,00
11627	35 x 29	10,5		21,00



GN 1/4 „SUPERBOX“

Akazienholz / acacia wood / madera de acacia / bois d'acacia



	cm	↑ cm	Farbe / Colour	€
11622	29,0 x 18,5	10,5		16,80
11628	29,0 x 18,5	10,5		16,80



GN „SUPERBOX VINTAGE“



Leichtes Holz, Tannenholz / fir wood / madera de abeto / bois sapin

	cm	↑ cm	GN	€
11700	55,5 x 35,0	10,5	GN 1/1	24,00
11701	35,0 x 29,0	10,5	GN 1/2	16,00
11702	29,0 x 18,5	10,5	GN 1/4	14,00
11703	55,0 x 18,5	10,5	GN 2/4	17,00



GN Tablett „ZERO“



GN tray
GN bandeja
GN plateau

	cm	↑ cm	GN	Farbe / Colour	€
84185	53,0 x 32,5	1,5	1/1		34,00
84195	53,0 x 32,5	1,5	1/1		34,00
84186	32,5 x 26,5	1,5	1/2		18,20
84196	32,5 x 26,5	1,5	1/2		18,20
84188	26,5 x 16,2	1,5	1/4		10,40
84198	26,5 x 16,2	1,5	1/4		10,40
84189	53,0 x 16,2	1,5	2/4		20,00
84199	53,0 x 16,2	1,5	2/4		20,00



GN Naturschieferplatten



GN natural slate tray
GN bandeja de pizarra natural
GN plat ardoise naturelle

	cm	GN	€
00990	53,0 x 32,5	1/1	15,00
00991	32,5 x 26,5	1/2	8,40
00993	26,5 x 16,2	1/4	4,60
00973	53,0 x 16,2	2/4	6,00



GN Einsatz „SUPERBOX“

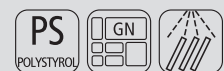

GN insert
GN bandeja
GN bac supérieur

	cm	↑ cm	GN	fits to	€
11616	53,0 x 32,5	8,5	GN 1/1	11620, 11626, 11700	29,00
11617	32,5 x 26,5	8,5	GN 1/2	11621, 11627, 11701	24,00



BRIDGE



Der „Alleskönner“ für Ihr Buffet! Mit hohem Anspruch an Design und Funktionalität haben wir das Buffet-System „Bridge“ für Sie entwickelt. Die perfekt aufeinander abgestimmten Komponenten unterstützen die Präsentation Ihrer Speisen und ermöglichen Ihnen den unkomplizierten Aufbau Ihrer einzigartigen Buffet-Landschaften. Die in den Holzoberflächen Ahorn und Wenge erhältlichen Artikel sind in ihren Höhen und ihren Volumina optimal aufeinander abgestimmt und gewährleisten einen einfachen und sicheren Umgang in Ihrem Gastronomiealltag.

The collection "Bridge" is bringing perfectly coordinated components for an uncomplicated and organized buffet system, finalizing in an unique buffet scenery. All pieces combine perfectly with one another in their variations of sizes and volumes. The wooden items are available in 2 colors, maple or wenge. A simple and safe handling is guaranteed.

Una colección universal para un buffet único: un Sistema funcional y fácil de componer, asociado a la elegancia de su exclusivo diseño. Los elementos se combinan a la perfección entre variaciones de Alturas y volúmenes, realizando sus propuestas y composiciones culinarias y modelando el paisaje del buffet. Las piezas están disponibles en 2 colores, wengué o arce. Manejo sencillo y seguro.

Une collection universelle pour une présentation unique de votre buffet: fonctionnel et facile à composer, ce système est à la fois pratique, simple et spectaculaire par son élégant design. Les différents éléments se marient à la perfection pour construire sans difficulté différentes compositions, variant les hauteurs et les volumes et mettant en valeur vos créations culinaires. Vous pouvez modeler vous-même votre buffet comme un paysage. Les pièces sont disponibles en deux couleurs, bois wengé ou érable. Manipulation aisée et sûre.



Kühlbox „BRIDGE“ refrigerated buffet display set de bufé refrigerado présentoir buffet froid

Set bestehend aus: 1 Gestell aus Ahorn oder Wenge, 1 Behälter aus Kunststoff, 1 GN1/1 Tablett aus Melamin, 1 Kühlakku, 1 Rolltophaube (fix montiert)
set consists of: 1 base element maple or wenge, 1 plastic insert black, 1 GN1/1 tray melamine, 1 cooler, 1 cover (fixed)
incluye: soporte de madera en arce o wengué, 1 cubeta de plástico, 1 bandeja de melamina GN1/1, 1 placa de frío GN 1/1, 1 campana rolltop (fija)
support bois en érable ou wengé, 1 bac plastique, 1 plat mélamine GN 1/1, 1 plaque de froid GN1/1, 1 cloche rolltop (fixe)



	cm	↑ cm	Farbe / Colour	€
13990	63,5 x 42,5	31	ahorn wood	334,00
14990	63,5 x 42,5	31	wenge wood	334,00



2 sizes
0,50 ltr. / 2,50 ltr.

Melaminschale
Kühlakku
Edelstahlschale
Gestell Holz

Kühlschale „BRIDGE“

cooling bowl
bol refrigerado
bol réfrigéré



4-teilig: 1 Gestell aus Ahorn oder Buche/Wenge, 1 Behälter aus Edelstahl,
1 Schale aus Melamin (Ø 14 cm o. 23 cm), 1 Kühlakku

4 pcs.: 1 base element maple or wenge, 1 bowl stainless steel,
1 bowl melamine (Ø 14 o. 23 cm), 1 cooler

set de 4 piezas: soporte madera arce o wengue, champanera
inox de doble pared. alzador interior, acumulador de frío

set de 4 pcs: support bois en érable ou wengue, seau inox
double paroi, rehausseur intérieur, accumulateur de froid

	cm	↑ cm	ltr.	Farbe / Colour	€
13980	18,5 x 18,5	10	0,50		51,50
13981	27,5 x 27,5	14	2,50		102,00

	cm	↑ cm	ltr.	Farbe / Colour	€
14980	18,5 x 18,5	10	0,50		51,50
14981	27,5 x 27,5	14	2,50		102,00



Edelstahlschale

stainless steel bowl
cuenco acero inoxidable
bol acier inoxydable



	Ø cm	↑ cm		€
30050	14	8,5		23,00
30052	23	13,5		51,50



Schale „CASUAL MAXI“

bowl
cuenco
bol



	Ø cm	↑ cm	ltr.	Farbe / Colour	€
83700	14	6,5	0,50		3,80
83702	23	10,5	2,50		9,00

	Ø cm	↑ cm	ltr.	Farbe / Colour	€
83701	14	6,5	0,50		3,80
83703	23	10,5	2,50		9,00



Frischhaltedeckel

airtight cover
tapa hermética
couvercle hermétique



	Ø cm		€
10890	14		10,50
10887	23		19,00

Kühlakku / cooler / acumulador de frío / accumulateur de froid

	Ø cm	↑ cm	€
10661	10,5	2,5	3,20
10777	15	2,5	5,00

Buffet & Display



Cerealienspender „BRIDGE“

cereal dispenser
dispensador de cereales
distributeur de céréales



Behälter herausnehmbar, „Feierabend-Deckel“ für das aromadichte Lagern, portionieren durch einfaches Drehen

removable canister, special lid to keep the cereals fresh, easy to use, rotate the button to get the muesli

contenedor movable, tapa especial para mantener los cereales frescos, fácil de usar, se gira el pomo para servir los cereales

réceptif amovible, couvercle spécial pour conserver les céréales, usage facile en tournant le bouton

	cm	↑ cm	ltr.	Farbe / Colour	€
13987	21 x 20	55,5	4,5	Ahorn / maple	102,00

inkl. 3 Magnetschilder:
ORANGE, APPLE, GRAPEFRUIT



4 ltr.

10870

Saftdispenser „BRIDGE“

juice dispenser
dispensador de zumo
distributeur à jus



Kühlung durch 2 Kühllakkus von oben und unten

cooling with 2 cooling elements from the top and base

2 acum. de frío 1 en la base y 1 en la tapa

2 plaques de froid 1 dans le couvercle, 1 dans le socle

	cm	↑ cm	ltr.	Farbe / Colour	€
10870	31,0 x 20,0	42	4	Ahorn / maple	224,00
10871	35,5 x 22,0	50	6	Ahorn / maple	264,00



Besteckbehälter „BRIDGE“

cutlery organizer
cajón para cubiertos
bac à couverts



2-teiliges Set: 1 Gestell, 1 Besteckbehälter (Nr. 11955), herausnehmbar

2 pcs set: 1 base element, 1 removable plastic container (item 11955)

set de 2 piezas: 1 soporte + 1 cubeta extraíble 4 compartimentos de plástico (ref. 11955)

set de 2 pcs: 1 support + 1 bac plastique amovible à 4 compartiments (réf. 11955)

	cm	↑ cm	Farbe / Colour	€
13995	57,5 x 37,0	12	Ahorn / maple	78,00



Konferenzkühler „BRIDGE“

bottle cooler
enfriador
refraîchisseur



2-teiliges Set, bestehend aus: 1 Gestell, 1 Behälter aus Edelstahl (doppelwandig)

2 pcs set: 1 base element, 1 bowl stainless steel (double-wall)

set de 2 piezas: 1 soporte, champanera inox de doble pared

set de 2 pcs: 1 support, seau inox double paroi

	cm	↑ cm	Farbe / Colour	€
13985	35 x 35	19	Ahorn / maple	154,00





Cerealispender „BRIDGE“

cereal dispenser
dispensador de cereales
distributeur de céréales



Behälter herausnehmbar, „Feierabend-Deckel“ für das aromadichte Lagern, portionieren durch einfaches Drehen

removable canister, special lid to keep the cereals fresh, easy to use, rotate the button to get the muesli

contenedor movable, tapa especial para mantener los cereales frescos, fácil de usar, se gira el pomo para servir los cereales

réipient amovible, couvercle spécial pour conserver les céréales, usage facile en tournant le bouton

	cm	↑ cm	ltr.	Farbe / Colour		€
14987	21 x 20	55,5	4,5	■	Wenge / wenge	102,00



Saftdispenser „BRIDGE“

juice dispenser
dispensador de zumo
distributeur à jus



Kühlung durch 2 Kühllakus von oben und unten

cooling with 2 cooling elements from the top and base

2 acum. de frío 1 en la base y 1 en la tapa

2 plaques de froid 1 dans le couvercle, 1 dans le socle

	cm	↑ cm	ltr.	Farbe / Colour		€
10872	31,0 x 20,0	42	4	■	Wenge / wenge	224,00
10873	35,5 x 22,0	50	6	■	Wenge / wenge	264,00



Besteckbehälter „BRIDGE“

cutlery organizer
cajón para cubiertos
bac à couverts



2 teiliges Set: 1 Gestell, 1 Besteckbehälter (Nr. 11955), herausnehmbar

2 pcs set: 1 base element, 1 removable plastic container (item 11955)

set de 2 piezas: 1 soporte + 1 cubeta extraíble 4 compartimentos de plástico (ref. 11955)

set de 2 pcs: 1 support + 1 bac plastique amovible à 4 compartiments (réf. 11955)

	cm	↑ cm	Farbe / Colour		€
14995	57,5 x 37,0	12	■	Wenge / wenge	78,00



Flaschenkühler „BRIDGE“

bottle cooler
enfriador
refraîchisseur



2-teiliges Set, bestehend aus: 1 Gestell, 1 Behälter aus Edelstahl (doppelwandig)

2 pcs set: 1 base element, 1 bowl stainless steel (double-wall)

set de 2 piezas: 1 soporte, champanera inox de doble pared

set de 2 pcs: 1 support, seau inox double paroi

	cm	↑ cm	Farbe / Colour		€
14985	35 x 35	19	■	Wenge / wenge	154,00

Buffet & Display



Tablett „SUNDAY“

tray
bandeja
plateau

hochglanzpoliert
mirror polished finish
acabado espejo pulido
effet brillant



	cm	↑ cm	GN	€
11220	53,0 x 32,5	2	1/1	38,00
11210	32,5 x 26,5	2	1/2	22,00
11211	Ø 46,0	2	–	46,00



GN Tablett „SUNDAY“

GN tray
GN bandeja
GN plateau

hochglanzpoliert, Griffe inkl. Fixierung, kein Verrutschen möglich, Nutzhöhe 4 cm
mirror polished finish, with handles for extra secure stacking, distance 4 cm
pulido espejo, con 2 asas para apilado muy estable, distancia 4 cm entre bandejas
effet brillant, 2 anses pour empilement très stable, distance 4 cm entre plateaux



	cm	↑ cm	GN	€
11222	53,0 x 32,5	6	1/1	52,00
11212	32,5 x 26,5	6	1/2	30,00



Buffetgestell „SUNDAY“

buffet stand
expositor bufé
présentoir buffet



3-teiliges Set: 1 Glasschale Ø 23 cm (2,5 Liter), 1 klappbarer Schutzdeckel, 1 Gestell
3 pcs. set: 1 glass bowl Ø 23 cm (2,5 litres), 1 hinged covers, 1 stand
3 piezas: 1 bol vidrio Ø 23 cm (2,5 l), 1 tapa con bisagra, 1 soporte
3 éléments: 1 bol verre Ø 23 cm (2,5 l), 1 couvercle à charnière, 1 support

	Ø cm	↑ cm	€
11794	24	17	36,00



Buffetgestell „SUNDAY“

buffet stand
expositor bufé
présentoir buffet



7-teiliges Set: 3 Glasschalen Ø 23 cm (2,5 Liter), 3 klappbare Schutzdeckel, 1 Gestell
7 pcs. set: 3 glass bowls Ø 23 cm (2,5 litres), 3 hinged covers, 1 stand
7 piezas: 3 boles vidrio Ø 23 cm (2,5 l), 3 tapas con bisagra, 1 soporte
7 éléments: 3 bols verre Ø 23 cm (2,5 l), 3 couvercles à charnière, 1 support

	cm	↑ cm	€
11795	61 x 24	35	119,00



Saftdispenser „SUNDAY“

juice dispenser
dispensador de zumo
distributeur à jus de fruit



matt poliert, Kühlung durch 2 Kühlakkus von oben und unten
satin polished finish, cooling with 2 cooling elements from the top and base
acabado pulido brillante, 2 acum. de frío (1 en la base y 1 en la tapa)
inox mat, 2 accus. de froid (1 socle et 1 couvercle)

	cm	↑ cm	ltr.	€
10860	21 x 35	48	6	264,00



Saft- / Milchdispenser „SUNDAY“

juice and milk dispenser
dispensador mixto zumo y leche
distributeur mixte à lait et à jus de fruit



matt poliert, Behälter gefrostet, Kühlung durch 2 Kühlakkus von oben und unten
satin polished finish, canister frosted look, cooling with 2 cooling elements from the top and base
inox acabado pulido mate, 1 recipiente policarbonato aspecto glaseado, 2 enfriadores en la base y en la tapa
inox mat, récipient polycarbonate opaque, 2 accus. de froid dans le socle et dans le couvercle

	cm	↑ cm	ltr.	€
10865	21 x 35	48	6	264,00



Saftdispenser DUO „SUNDAY“

juice dispenser
dispensador de zumo doble
distributeur à jus de fruit double



matt poliert, Kühlung durch 4 Kühlakkus von oben und unten
satin polished finish, cooling with 4 cooling elements from the top and base
inox acabado pulido mate, 4 enfriadores en la base y en la tapa
inox mat, 4 accus. de froid (socle et couvercle)

	cm	↑ cm	ltr.	€
10862	35 x 45	48	2 x 6	399,00



Saft- / Milchdispenser DUO „SUNDAY“

juice and milk dispenser
dispensador mixto zumo y leche
distributeur mixte à lait et à jus de fruit



matt poliert, 1 Behälter gefrostet, 1 Behälter transparent, 4 Kühlakkus von oben und unten
satin polished finish, 1 canister frosted look, 1 canister transparent, cooling with 4 cooling elements from the top and base
inox mate, 1 recipiente opaco, 1 recipiente transparente, 4 enfriadores (base y tapa)
inox mat, 1 récipient opaque, 1 récipient transparent, 4 accus. de froid (socle et couvercle)

	cm	↑ cm	ltr.	€
10864	35 x 45	48	2 x 6	399,00

Saftbehälter transparent, ohne Zapfhahn / juice canister transparent, without tap / contenedor transparente sin grifo / récipient cylindrique sans le robinet

	Ø cm	↑ cm	ltr.	€
10806	22	26	6	106,00

Milchbehälter, gefrostet, ohne Zapfhahn / milk canister, frosted look, without tap / contenedor de leche, efecto glaseado, sin grifo / récipient cylindrique mat (idéal pour le lait) sans le robinet

	Ø cm	↑ cm	ltr.	€
10805	22	26	6	111,00

Hahn / tap / grifo / robinet

				€
10867				41,50



PROFI LINE



GN Edelstahl-Tablett „PROFI LINE“

GN tray
GN bandeja
GN plat empilable système catering



	cm	↑ cm	GN		€
11100	53,0 x 32,5	1,5	1/1	mit glattem Rand / without decor-edge sin borde decorado / bords lisses	27,00
12100	32,5 x 26,5	1,5	1/2	mit glattem Rand / without decor-edge sin borde decorado / bords lisses	16,00
11000	53,0 x 32,5	1,5	1/1	mit Dekor-Rand / with decor-edge con borde decorado / bords avec relief	27,00
12000	32,5 x 26,5	1,5	1/2	mit Dekor-Rand / with decor-edge con borde decorado / bords avec relief	17,50
11110	53,0 x 32,5	1,0	1/1	glatter schmaler Rand / smooth narrow edge / borde estrecho liso / bord étroit lisse	16,00



Fleisch- und Gemüseplatte „PROFI LINE“

tray
fuente de servicio
plat de service

Dekorrand hochglanzpoliert
decor edge mirror polished finish
borde decorado pulido efecto espejo
contour relief avec effet miroir



	Ø cm	↑ cm		€
11032	32	2,6		18,20
11038	38	2,6		27,20
11048	48	2,6		34,60



Fleisch- und Gemüseplatte „PROFI LINE“

tray
fuente de servicio
plat de service

Dekorrand hochglanzpoliert
decor edge mirror polished finish
borde decorado pulido efecto espejo
contour relief avec effet miroir



	cm	↑ cm		€
11023	50 x 36	2,6		34,60
11024	60 x 41	2,6		47,20
11025	70 x 46	2,6		65,40



GN Edelstahl-Behälter „PROFI LINE“

GN pan
GN cubeta
GN bac



	cm	↑ cm	GN	litr.	€
11020	53,0 x 32,5	2,0	1/1	1,7	30,90
11040	53,0 x 32,5	4,0	1/1	3,4	33,80
11065	53,0 x 32,5	6,5	1/1	7,0	37,40
12040	32,5 x 26,5	4,0	1/2	2,0	20,40
12065	32,5 x 26,5	6,5	1/2	3,3	23,30



Distanzstücke erhöhen die Nutzhöhe auf 8 cm

GN 1/1 System-Tablett „PROFI LINE“

GN 1/1 tray
GN 1/1 bandeja
GN 1/1 plateau



Dekorrand hochglanzpoliert, massive Griffe verchromt, inkl. fest verschraubten Distanzstücken, Nutzhöhe 4 cm

decor edge mirror polished finish, chrome plated handles, incl. mounted 4 cm distance pillars
borde decorado pulido brillante, asas cromadas, incl. distanciadores atornillados, con profundidad efectiva de 4 cm

bord avec reliefs poli miroir, poignées chromées, incl. distance bien fixée avec hauteur utile de 4 cm

	cm	GN	€
11300	53 x 32,5	1/1	39,50

8 cm Distanzstück 4 Stück, verchromt / 8 cm distance pillars 4 pcs., chrome plated / distanciadores de 8 cm, 4 pzas, cromados / kit réhausseur de 8 cm, 4 pcs., chromés

11310	8 cm Distanzstücke können per Hand aufgeschraubt werden 8 cm distance pieces can be bolted by hand		21,00
-------	---	--	-------

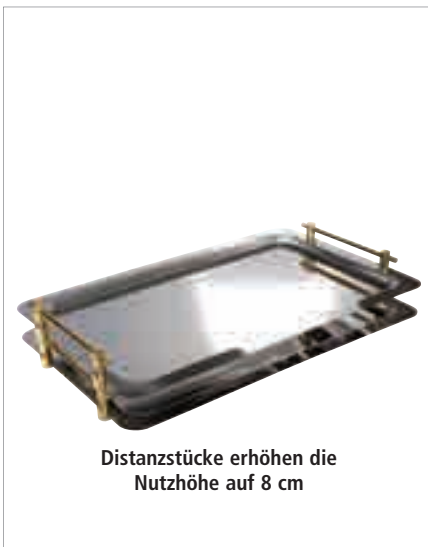

Distanzstücke erhöhen die Nutzhöhe auf 8 cm

GN 1/1 System-Tablett „PROFI LINE“

GN 1/1 tray
GN 1/1 bandeja
GN 1/1 plateau



Rand hochglanzpoliert, massive Bügelgriffe vergoldet, inkl. fest verschraubten Distanzstücken, Nutzhöhe 4 cm

mirror polished finish edge, gold plated handles, stackable approx. 4 cm

borde pulido brillante, asas doradas, incl. distanciadores atornillados, con profundidad efectiva de 4 cm

bord poli miroir, poignées dorées, incl. distance bien fixée avec hauteur utile de 4 cm

	cm	GN	€
11290	53 x 32,5	1/1	33,00

8 cm Distanzstück-Set, 4 Stück, vergoldet / 8 cm distance pillars, 4 pcs., gold plated / distanciadores de 8 cm, 4 pzas, dorados / kit réhausseur de 8 cm, 4 pcs., dorés

11252	8 cm Distanzstücke können per Hand aufgeschraubt werden 8 cm distance pieces can be bolted by hand		19,30
-------	---	--	-------



11150 mit verchromten Griffen

11155 mit vergoldeten Griffen

GN 1/1 System-Tablett „BUFFET-STAR“

GN 1/1 tray
GN 1/1 bandeja
GN 1/1 plateau



Rand hochglanzpoliert, inkl. fest verschraubten Griffen inkl. Distanzstücken, Nutzhöhe 4 cm

mirror polished finish edge, incl. screwed handles incl. distance pillars, 4 cm distance

borde pulido brillante, incl. asas atornillables, incl. distanciadores con profundidad efectiva de 4 cm

bord poli miroir, incl. poignées à visser, incl. distance avec hauteur utile de 4 cm

	cm	GN	€
11150	53 x 32,5	1/1	33,00

mit verchromten Griffen / with chrome plated handles / con asas cromadas / avec poignées chromées

mit vergoldeten Griffen / with gold plated handles / con asas doradas / avec poignées dorées

Buffet & Display



System-Tablett „BUFFET-STAR“

system tray
bandeja del sistema
plat empilable système catering



Rand hochglanzpoliert, inkl. fest verschraubten Griffen inkl. Distanzstücken, Nutzhöhe 4 cm
mirror polished finish edge, incl. screwed handles incl. distance pillars, 4 cm distance
borde pulido efecto espejo, incluye asas atornillables, distanciadores a 4 cm
contour effet miroir, poignées à visser, distance approx. 4 cm

	Ø cm		€
11160	48	mit verchromten Griffen / with chrome handles	46,00
11165	48	mit verchromten Griffen / with chrome handles	49,00



GN 1/1 System-Tablett „CLASSIC“

GN tray
GN bandeja
GN plat empilable système catering



Rand hochglanzpoliert, mit fest verschraubten Griffen inkl. Distanzstücken, Nutzhöhe 3,5 cm
mirror polished finish edge, incl. screwed handles incl. distance pillars, 3,5 cm distance
borde pulido efecto espejo, incluye asas atornillables, distanciadores a 3,5 cm
contour effet miroir, poignées à visser, distance approx. 3,5 cm

	cm	GN	€
11295	53 x 32,5	1/1	34,00



Tablett „SWING“

tray
bandeja
plateau



Rand matt poliert, innen hochglanzpoliert
satin polished finish edge, inside mirror polished finish
borde pulido efecto satinado, interior pulido efecto espejo
contour effet mat, intérieur poli miroir

	cm	↑ cm	GN	€
01416	32,5 x 32,5	1		24,00
01415	28,5 x 20,0	1		18,00
01420	53,0 x 32,5	1	1/1	39,00



Tablett „SUNDAY“

tray
bandeja
plateau



hochglanzpoliert
mirror polished finish
acabado espejo pulido
effet brillant

	cm	↑ cm	GN	€
11220	53,0 x 32,5	2	1/1	38,00
11210	32,5 x 26,5	2	1/2	22,00
11211	Ø46	2	—	46,00



GN Tablett „SUNDAY“

GN tray
GN bandeja
GN plateau



hochglanzpoliert, Griffe inkl. Fixierung, kein Verrutschen möglich, Nutzhöhe 4 cm
mirror polished finish, with handles for extra secure stacking, distance 4 cm
pulido espejo, con 2 asas para apilado muy estable, distancia 4 cm entre bandejas
effet brillant, 2 anses pour empilement très stable, distance 4 cm entre plateaux

	cm	↑ cm	GN	€
11222	53,0 x 32,5	6	1/1	52,00
11212	32,5 x 26,5	6	1/2	30,00



GN 1/1 Buffet-Set „CATERER“

GN 1/1 buffet set
GN 1/1 set de bufé
GN 1/1 set catering: plateau + cloche



2-teilig: Tablett + Haube, Tablett fixiert sich auf der Haube - kein Rutschen möglich
2 pcs. set: tray + cover, tray fixes itself on the cover and can not slip off
set de 2 piezas: bandeja + tapa, la bandeja encaja encima de la tapa para que no se deslice
ensemble de 2 pièces: plateau GN 1/1 réf. + cloche spéciale empilement stable

	cm	↑ cm	GN	€
11195	53 x 32,5	10,5	1/1	63,70



GN 1/1 Buffet-Set „HOCHSTAPLER“

GN 1/1 buffet set
GN 1/1 set de bufé
GN 1/1 kit catering plateau + cloche



2-teilig: Tablett + Haube, Tablett fixiert sich auf der Haube - kein Rutschen möglich
2 pcs. set: tray + cover, tray fixes itself on the cover and can not slip off
set de 2 piezas: bandeja + tapa, la bandeja encaja encima de la tapa para que no se deslice
ensemble de 2 pièces: plateau GN 1/1 réf. + cloche spéciale empilement stable

	cm	↑ cm	GN	€
11302	53 x 32,5	10,5	1/1	68,00



GN 1/1 Haube „HOCHSTAPLER“

GN 1/1 cover
GN 1/1 campana
GN 1/1 cloche



glasklarer Kunststoff, Tablett fixiert sich auf der Haube - kein Rutschen möglich, nahezu bruchfest
clear plastic, tray fixes itself on the cover and can not slip off, nearly unbreakable
plástico transparente, la bandeja se fija a la tapa para que no se deslice, muy resistente a la rotura
en plastique transparent, le plat se fixe sur le dessous de la cloche pour ne pas glisser, très résistant à la casse

	cm	↑ cm	fits to	GN	€
11305	53 x 32,5	9	11300, 11290, 11295	1/1	30,00



GN Abdeckhaube

GN cover
GN cubierta
GN cloche



	cm	↑ cm	✂ mm	GN	€
11041	32,5 x 26,5	9,5	3	1/2	20,00
11042	53,0 x 32,5	9,5	3	1/1	28,00
11043 <small>NEW</small>	32,5 x 17,6	10,5	3	1/3	15,00
11044 <small>NEW</small>	53,0 x 16,2	10,5	3	2/4	20,00

Buffet & Display



Tablett „SCHÖNER ESSEN“

tray
bandeja
plateau



	cm		€
00383	35,0 x 24,0		6,80
00382	42,0 x 31,0		9,80
00381	50,0 x 36,0		14,00
00384	63,5 x 44,5		27,00
00385	60,0 x 40,0		25,00
	cm		€
03824	42,0 x 31,0	leichte Ausführung 0,5 mm / extra light model 0,5 mm modelo extraligero 0,5 mm / qualité légère, ép. 0,5 mm	8,80
03814	50,0 x 36,0	leichte Ausführung 0,5 mm / extra light model 0,5 mm modelo extraligero 0,5 mm / qualité légère, ép. 0,5 mm	10,00



GN 1/1 Tablett „SCHÖNER ESSEN“

GN tray
GN bandeja
GN plateau



	cm	GN	€
00388	53,0 x 32,5	1/1	15,40



Tablett „SCHÖNER ESSEN“

tray
bandeja
plateau



mit Dekorrand, Griffe Zinkdruckguss verchromt, genietet
with decor edge, handles zinc alloy chrome plated, riveted
borde decorado, asas fundición con zinc
bord décor, poignées en fonte zinguée

	cm		€
00082	52 x 31,0		15,00
00081	60 x 36,0		20,80
00084	75 x 44,5		35,00



Fleisch-/Gemüseplatte „SCHÖNER ESSEN“

meat / vegetable platter
plato de carne / verduras
assiette de viande / légumes



	cm		€
00087	38 x 23	rechteckig, abgerundet / rectangular, rounded edge rectangular / rectangulaire	8,00



Fleisch-/Gemüseplatte „SCHÖNER ESSEN“

meat / vegetable platter
plato de carne / verduras
assiette de viande / légumes



	cm		€
00089	50 x 39,5		15,00



00075

Tablett „SCHÖNER ESSEN“

tray
bandeja
plateau



	Ø cm	€
00075	31	6,30
00085	35	8,60



Tablett mit Haube „SCHÖNER ESSEN“

tray with cover
bandeja con cubierta
plateau avec cloche



	cm	↑ cm	€
38202	42 x 31	8,0	14,00

Haube / cover / campana / cloche

	cm	↑ cm	€
08201	36,5 x 26,0	7,5	3,90



GN 1/1 Tablett „STAR“

GN tray
GN bandeja
GN plateau



Rand hochglanzpoliert mit Prägung

polished decor edge
borde pulido decorado
bords polis miroir, avec relief sur les petits côtés

	cm	GN	€
11115	53 x 32,5	1/1	27,50



griffig, keine Fingerabdrücke sichtbar, Randprägung auf kurzen Seiten
catchy, fingerprints are not visible, edge lettering on the short sides



GN 1/1 Buffet-Tablett „HALBMOND“

GN tray
GN bandeja
GN plat demi-lune



mit klassischem Linienprägedekor, passend für Thermoboxen GN 1/1 und Thermoporte

with decor edge, usable in thermoboxes GN 1/1
con borde decorado, apto para cajas térmicas GN 1/1
bords avec relief, apte pour conteneurs GN 1/1

	cm	GN	€
11111	53 x 32,5	1/1	18,00



hot price

oval

Edelstahl-Schale

bowl
bandeja ovalada inox
corbeille ovale inox



ingerollter Rand

rolled edge
borde redondeado
bord roulé

	cm	↑ cm	€
40110	26,5 x 18,5	4,0	7,40
40115	31,0 x 21,0	4,5	10,50

Buffet & Display



Tablett „FINESSE“

tray
bandeja
plateau



	cm	€
01314	30 x 24	7,80
01313	35 x 24	9,00
01317	39 x 26	10,20
01312	42 x 31	11,50
01318	48 x 30	11,00
01311	50 x 38	16,00
01310	58 x 42	27,00
01309	68 x 48	38,00



Tablett „FINESSE“

tray
bandeja
plateau



	Ø cm	€
01332	32	8,60
01335	35	10,20
01338	38	11,50
01348	48	21,40
01349	48,5	22,80
01358	58	49,00



Tablett „FINESSE“

tray
bandeja
plateau



	cm	€
01322	42 x 30	13,80
01323	50 x 36	20,00
01324	60 x 41	28,00
01325	70 x 46	40,50



Tablett „FINESSE“

tray
bandeja
plateau



verchromte Messing-Griffe
chrome plated brass handles
asas plateadas de latón
poignées en laiton chromées

	Ø cm		€
01738	38	rund / round / redondo / rond	21,10
01748	48	rund / round / redondo / rond	34,60



Käseglocken-Set „BRAZIL“

rolltop set
set rolltop
set cloche á fromage



3-teilig: Tablett + Holzschneidebrett + Rolltophaube glasklar, rutschfeste Haubenfixierung

3 pcs. set: tray + wooden board + rolltop cover, cover non-slip fixed
set de 3 piezas: bandeja + tablero de madera + campana abatible, fijación antideslizante
set de 3 pièces: plateau + planche à découper + cloche abattante, fixation antiglisse

	Ø cm	↑ cm	€
09085	45	24	72,00



Rolltop-Set

rolltop set
set rolltop
set cloche à fromage



2-teilig: Tablett + Rolltophaube glasklar, rutschfeste Haubenfixierung, klappbar

2 pcs. set: tray + rolltop cover, cover non-slip fixed, mountable
set de 2 piezas: bandeja + campana abatible fijación antideslizante, montable
set de 2 pièces: plateau + cloche abattante, fixation antiglisse, montable

	Ø cm	↑ cm	€
09080	38	24	34,00
09099	50	28	75,00



Rolltop-Set

rolltop set
set rolltop
set rolltop



2-teilig: Schneidbrett marmoriert + Rolltophaube glasklar, rutschfeste Haubenfixierung, klappbar

2 pcs. set: plastic board + rolltop cover, cover non-slip fixed, mountable
set de 2 piezas: tablero de plástico + tapa abatible, tapa antideslizante, montable
set de 2 pièces: planche à découper + cloche abattante, fixation antiglisse, montable

	Ø cm	↑ cm	€
09081	38	24	46,00



Buffet-Set

buffet set
set de bufé
présentoir pour le buffet



2-teilig: Platte + Rolltophaube, schnidfeste und porenfreie Oberfläche, rutschfeste Haubenfixierung, Platte mit rutschfesten Füßen

2 pcs. set: glass board + rolltop cover, scratch-resistant surface, cover non-slip fixed, non-slip feets
set de 2 piezas: bandeja vidrio redonda + campana abatible, fijación antideslizante, pies antideslizantes
set de 2 pièces: plateau verre rond + cloche abattante, fixation antiglisse et pieds antidérapants

	Ø cm	↑ cm	€
00978	38	23	34,00

Rolltop-Haube mit Löchern / rolltop cover / campana abatible / cloche basculante

	Ø cm	↑ cm	€
18394	38	20	20,00

Glasplatte / glass plate / bandeja de vidrio / plateau verre

	Ø cm	↑ cm	€
00972	38	3	13,50

Buffet & Display



Tablett „FINESSE“

tray
bandeja
plateau

verchromte Messing-Griffe
chrome plated brass handles
asas de latón cromadas
poignées en laiton chromées



	cm	€
01712	44 x 31	20,40
01711	52 x 38	26,50
01710	60 x 42	39,00
01709	70 x 48	51,50



Tablett mit Haube „FINESSE“

tray with cover
bandeja con campana
plateau avec cloche



	cm	↑ cm	€
13122	42 x 31	8,5	18,40



Tablett mit Haube „FINESSE“

tray with cover
bandeja con campana
plateau avec cloche



	Ø cm	↑ cm	€
13622	22	9,5	6,20



Tablett mit Haube „FINESSE“

tray with cover
bandeja con cubierta
plateau avec cloche



	Ø cm	↑ cm	€
13382	38	12	19,00
13385	38	13	20,50



Edelstahltablett

tray
bandeja
plateau



	cm	↑ cm	€
09010	43,5 x 32,5	1,5	19,00

Rolltophaube „PURE“ / rolltop cover / campana abatible / cloche basculante

	cm	↑ cm	€
09013	44 x 33,5	17	24,00



Tablett „ELEGANCE“

tray
bandeja
plateau



	cm	€
02310	41 x 26	12,60
02311	48 x 30	16,00
02312	60 x 37	24,00



Tablett mit Haube „ELEGANCE“

tray with cover
bandeja con cubierta
plateau avec cloche



	cm	↑ cm	€
23642	35 x 19	10	9,00



Serviertablett mit Haube

tray
bandeja
plateau



	cm	↑ cm	€
00064	34 x 16,5	10	5,90
00067	25 x 19	7	6,40

Haube für 00064 / cover for 00064 / campana para 00064 / cloche pour 00064

06401	3,00
-------	------

Haube für 00067 / cover for 00067 / campana para 00067 / cloche pour 00067

06701	2,00
-------	------



Tortenplatte mit Haube

cake plate with cover
bandeja tarta con campana
plat à tarte avec cloche



	Ø cm	↑ cm		€
00065	30	11	mit 1 Haube / with 1 cover	6,40
00652	30	7 + 11	mit 2 Hauben / with 2 cover	7,90



Tortenplatte „BAROCK“

cake plate
bandeja tartas
plat à gâteau



2-teilig: Tortenplatte mit Barock-Rand + Haube (extra stabil)

2 pcs. set: cake plate with decor edge „Barok“ + cover (extra robust)

set 2 piezas: porta tartas, borde decor „Barok“ + campana (extra fuerte)

set 2 pcs: plateau bord décor „Barok“ + cloche ultra-résistante

	Ø cm	↑ cm	€
06503	32	10	10,00

Frischhalte-Haube / cover / campana / cloche

	Ø cm	↑ cm	€
06510	30	11,5	4,40

PARTYPLATTEN

Nicht säure- und spülmaschinenfest, Lebensmittel nur mit Papierdeckchenunterlage servieren.

Non-acid and dishwasher-proof, serve food only with paper tray covers.

No resistente a los ácidos y al lavavajillas, servir alimentos sólo con papel para bandeja party.

Pas résistant aux acides et au lave-vaisselle, servent la nourriture seulement avec papier dentelles.



00393 oder / or 00396
96 x

00391 oder / or 00398
96 x

00392 oder / or 00399
96 x

00394 oder / or 00395
96 x

Warenträger

display
expositor
présentoir

für Partyplatten

- platzsparende flexible Präsentation durch geringe Abmessungen
- als Zweitplatzierung für Ihre zusätzlichen Umsätze
- in weiß lieferbar

for partytrays- space saving presentation- small size- available in white
para bandejas Party, ocupa poco espacio, disponible en blanco
pour plateaux Party, occupe très peu d'espace, disponible en blanc

	cm	↑ cm
00397	55 x 65	190



GN 1/1
00395

Partyplatte „CLASSIC“

partytray
bandeja party
plateau party



mit Liniendekor, Rand eingerollt

with line decor, rolled edge
con filos en relieve
avec décoration lignée, bord rond

	cm	VE / unit	GN	€/ pc.
00395	53,0 x 32,5	36	1/1	5,20
00399	41,0 x 31,0	48		3,20
00389	35,4 x 32,5	48	2/3	3,00



Partyplatte „CLASSIC“

partytray
bandeja party
plateau party



mit Liniendekor, Rand eingerollt

with line decor, rolled edge
con filos en relieve
avec décoration lignée, bord rond

	Ø cm	VE / unit	€/ pc.
00396	35	48	3,20



oval

Partyplatte „CLASSIC“

partytray
bandeja party
plateau party



mit Liniendekor, Rand eingerollt

with line decor, rolled edge
con filos en relieve
avec décoration lignée, bord rond

	cm	VE / unit	€/ pc.
00398	46,0 x 34,0	48	3,20

hot price



Partyplatte
partytray
bandeja party
plateau party



Innenfläche ziseliert, Rand eingerollt
rolled edge, decorated surface
borde redondeado, superficie totalmente decorada
bord rond, surface entièrement ciselée

	Ø cm	VE / unit	€ / pc.
00393	35	48	3,20

hot price



oval

Partyplatte
partytray
bandeja party
plateau party



Innenfläche ziseliert, Rand eingerollt
rolled edge, decorated surface
borde redondeado, superficie totalmente decorada
bord rond, surface entièrement ciselée

	cm	VE / unit	€ / pc.
00391	46 x 34	48	3,20

hot price



Partyplatte
partytray
bandeja party
plateau party



Innenfläche ziseliert, Rand eingerollt
rolled edge, decorated surface
borde redondeado, superficie totalmente decorada
bord rond, surface entièrement ciselée

	cm	VE / unit	€ / pc.
00392	41 x 31	48	3,20

hot price



GN 1/1

GN 1/1 Partyplatte
GN partytray
GN bandeja party
GN plateau party



Innenfläche ziseliert, Rand eingerollt
rolled edge, decorated surface
borde redondeado, superficie totalmente decorada
bord rond, surface entièrement ciselée

	cm	VE / unit	GN	€ / pc.
00394	53 x 32,5	36	1/1	5,20

Buffet & Display



Serviertablett „KAFFEEHAUS“

tray
bandeja
plateau



	cm	↑ cm	Farbe / Colour	€
84250	26,0 x 20,0	1,5	White	4,20
84252	28,5 x 21,5	1,5	White	4,80
84251	26,0 x 20,0	1,5	Black	4,20
84253	28,5 x 21,5	1,5	Black	4,80



Serviertablett „KAFFEEHAUS“

tray
bandeja
plateau



Innenfläche ziseliert, Rand eingerollt
rolled edge
borde redondeado, superficie decor relieve
bord rond, surface entièrement ciselée

	cm	pcs.	€
30114	30 x 22	48	2,80



Serviertablett „KAFFEEHAUS“

tray
bandeja
plateau



matt poliert, Rand eingerollt
satin polished finish, rolled edge
acabado pulido satinado, borde redondeado
effet satin mat, bord rond

	cm	↑ cm	€
30122	20 x 20	1,5	8,50
30119	23 x 23	1,5	10,50



Serviertablett „KAFFEEHAUS“

tray
bandeja
plateau



matt poliert, Rand eingerollt
satin polished finish, rolled edge
acabado pulido satinado, borde redondeado
effet satin mat, bord rond

	cm	↑ cm	€
30120	20 x 11	1,5	6,40
30118	21,5 x 13	1,5	6,70
30121	29 x 20	1,5	13,20



Serviertablett „KAFFEEHAUS“

tray
bandeja
plateau



	cm	↑ cm		€
30126	25,5 x 19,5	2	mattiert / satin polished finish acabado efecto satinado / fini mat effet satin	6,30
30127	30 x 23	2	mattiert / satin polished finish acabado efecto satinado / fini mat effet satin	8,50
30136	25,5 x 19,5	2	hochglanzpoliert / mirror polished finish acabado espejo pulido / poli brillant miroir	6,30
30137	30 x 23	2	hochglanzpoliert / mirror polished finish acabado espejo pulido / poli brillant miroir	8,50

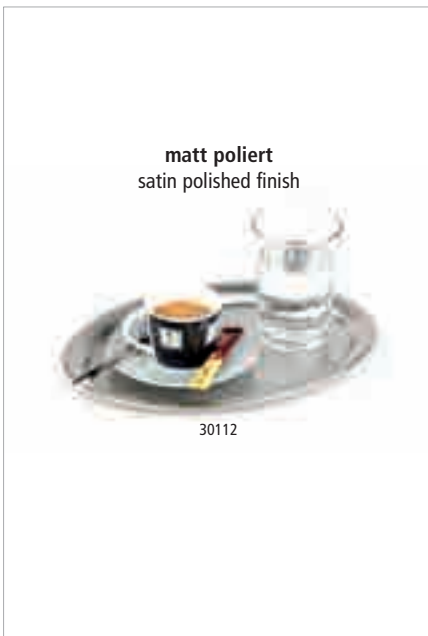

Serviertablett „KAFFEEHAUS“

tray
bandeja
plateau



matt poliert, oval, Rand eingerollt
satin polished finish, oval, rolled edge
pulido acabado efecto satinado, oval, borde redondeado
effet satin, ovale, bord rond

	cm	↑ cm		€
30111	19 x 15	1	für Zucker und Sahne / for sugar and cream para azúcar y crema / pour le sucre et la crème	4,30
30112	26,5 x 19	1	für eine Tasse / for one cup para una taza / pour une tasse	6,50
30113	29 x 22	1	für zwei Tassen / for two cups para dos tazas / pour deux tasses	6,90
30123	23 x 17,5	1	Eisdielen-Größe / icecream pralor size tamaño especial para heladerías / taille spéciale pour glaciers	6,10



Serviertablett „KAFFEEHAUS“

tray
bandeja
plateau



hochglanzpoliert, oval, Rand eingerollt
mirror polished finish, oval, rolled edge
pulido efecto espejo, ovalado, borde redondeado
effet brillant, ovale, bord rond

	cm	↑ cm		€
30115	19 x 15	1	für Zucker und Sahne / for sugar and cream para azúcar y crema / pour le sucre et la crème	4,30
30116	26,5 x 19	1	für eine Tasse / for one cup para una taza / pour une tasse	6,50
30117	29 x 22	1	für zwei Tassen / for two cups para dos tazas / pour deux tasses	6,90
30124	23 x 17,5	1	Eisdielen-Größe / icecream pralor size tamaño especial para heladerías / taille spéciale pour glaciers	6,10

Naturschiefer



GN Naturschieferplatten

GN natural slate tray
GN bandeja de pizarra natural
GN plat ardoise naturelle



hervorragende Kältespeicherung durch Naturschiefer, die Kanten der Platten sind gebrochen und nicht gesägt
excellent coldness store, food safe, waterproof
excelente conservador del frio, para reforzar la estética natural, los bordes ofrecen un canto irregular
excellent maintien du froid, les bords sont volontairement cassés pour renforcer l'esthétique naturelle

	cm	✂ mm	GN	€
00990	53,0 x 32,5	6 - 9	1/1	15,00
00991	32,5 x 26,5	6 - 9	1/2	8,40
00992	32,5 x 17,6	6 - 9	1/3	5,00
00993	26,5 x 16,2	6 - 9	1/4	4,60
00973	53,0 x 16,2	6 - 9	2/4	6,00



Naturschieferplatte

natural slate tray
bandeja de pizarra natural
plat ardoise naturelle



	cm	✂ mm	€
00996	45 x 30	6 - 9	12,00

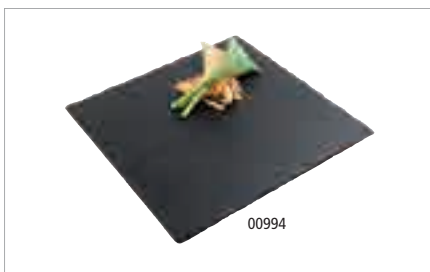

Naturschieferplatte

natural slate tray
bandeja de pizarra natural
plat ardoise naturelle



	cm	✂ mm	€
00994	25 x 25	6 - 9	6,00
00995	30 x 30	6 - 9	9,00

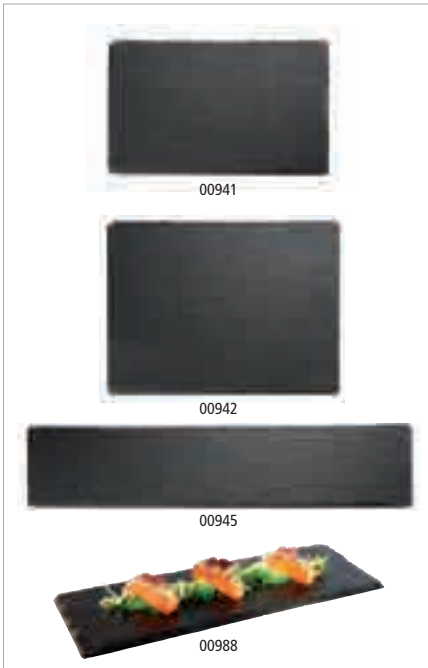

Naturschieferplatte
 natural slate
 bandeja de pizarra natural
 plateau ardoise naturelle



	cm	✦ mm	€
00941	24,0 x 15,0	6 - 9	3,90
00942	26,5 x 20,5	6 - 9	6,00
00945	47,0 x 10,0	6 - 9	6,00
00988	30,0 x 12,0	6 - 9	4,00

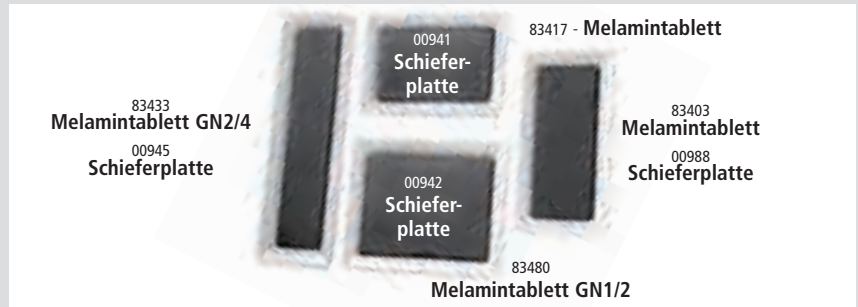

GN 1/1 Naturschieferplatte „HOCHSTAPLER“
 GN 1/1 natural slate tray
 GN 1/1 bandeja de pizarra natural
 GN 1/1 plat ardoise naturelle

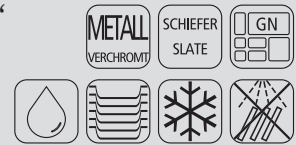

	cm	↑ cm	mm	€
00966	53,0 x 32,5	6	6 - 9	32,00



Griffe verchromt, 4 cm Nutzhöhe
 chrome plate handles, 4 cm distance



Naturschieferplatte
 natural slate tray
 bandeja pizarra natural
 plat ardoise naturelle



mit Absatz Ø 6 cm
 with hole Ø 6 cm
 con agujero Ø 6 cm
 avec trou Ø 6,0 cm

	cm	✦ mm	€
00986	25 x 12	6 - 9	3,90

passende Gläser:
 82310, 82312, 82314, 82316



Naturschieferplatte
 natural slate tray
 bandeja pizarra natural
 plat ardoise naturelle



mit 3 Absätzen, Ø 6 cm
 with 3 holes, Ø 6 cm
 con 3 agujeros, Ø 6 cm
 avec 3 trous, Ø 6 cm

	cm	✦ mm	€
00987	28 x 10	6 - 9	5,40

passende Gläser:
 82310, 82312, 82314, 82316

Buffet & Display



Naturschieferplatte „STARTER“

natural slate tray
bandeja de pizarra natural
plat ardoise naturelle carré



	cm	mm	€
00937	20 x 10	6 - 9	2,90



Naturschieferplatte / Untersetzer

natural slate tray
bandeja de pizarra natural
plateau ardoise naturelle



mit 2 Absätzen Ø 6 cm
with 2 holes Ø 6 cm
con 2 agujeros Ø 6 cm
avec 2 trous Ø 6 cm

	cm	mm	€
00971	15 x 8	6 - 9	3,00



Naturschieferplatte

natural slate tray
bandeja de pizarra natural
plat ardoise naturelle



	Ø cm	mm	€
00968	22	6 - 9	4,90
00969	28	6 - 9	7,00
00998	33	6 - 9	8,00
00999	38	6 - 9	12,00



Tortenplatte / Servierplatte drehbar

cake stand
soporte para pastel
présentoir à gâteaux



	Ø cm	↑ cm	mm	€
00975	32	2,5	6 - 9	16,00



drehbar
rotating



Rolltop-Set, 3-teilig

rolltop set, 3 pcs.
set rolltop, 3 piezas
set rolltop, 3 pièces



1 Edelstahlblech Ø 38 cm + 1 Naturschieferplatte Ø 33 cm + 1 Rolltophaube Ø 38 cm
1 stainless tray Ø 38 cm + 1 natural slate tray Ø 33 cm + 1 rolltop cover Ø 38 cm
1 bandeja de acero inoxidable Ø 38 cm + 1 bandeja de pizarra natural Ø 33 cm + 1 tapa abatible Ø 38 cm
1 plat inox 38 cm + 1 plat ardoise naturelle 33 cm + 1 cloche 38 cm

	Ø cm	↑ cm	€
01000	38	24	44,00



3-stufige Etagère

3-tier tray
bandeja con tres alturas
étagère carré 3 hauteurs

Naturschiefer, Akazienholz
natural slate tray, wood akazie
bandeja de pizarra natural, madera
plateau ardoise naturelle, bois



	Ø cm	↑ cm	✱ mm	€
00960	30 / 25 / 20	34	6 - 9	26,00



2-stufige Etagère

2-tier tray
bandeja dos alturas
étagère carré 2 hauteurs

Naturschiefer
natural slate tray
bandeja de pizarra natural
plateau ardoise naturelle



	Ø cm	↑ cm	✱ mm	€
00989	25 / 20	24	6 - 9	13,20



Naturschieferplatte, 2-teilig

natural slate tray, 2 pcs. set
bandeja de pizarra natural y campana
plateau ardoise naturelle et cloche en verre

mit Glashaube
with glass cover
con tapa de cristal
avec cloche en verre



	Ø cm	↑ cm	✱ mm	€
00984	10,5	8	6 - 9	8,00



Naturschieferplatten, 4er Set

natural slate tray, 4 pcs. set
bandeja pizarra natural, set de 4 unidades
plat ardoise naturelles, pack de 4



	cm	✱ mm	pcs.	€
00997	10 x 10	6 - 9	4	8,00



GENUSSPALETTE



GN 1/1 Servierbrett „GENUSSPALETTE“

GN 1/1 serving board
GN 1/1 tabla de servir
GN 1/1 planche de service

HOLZ
WOOD



Genusspalette im Kleinformat, Birke

mini serving palett, birch
tabla de servir, formato pequeño, abedul
planche de service, petit format, bouleau

	cm	↑ cm	GN	€
00879	53,0 x 32,5	3	1/1	29,00



Servierbrett „GENUSSPALETTE“

serving board
tabla de servir
planche de service

HOLZ
WOOD



Genusspalette im Kleinformat, Birke

mini serving palett, birch
tabla de servir, formato pequeño, abedul
planche de service, petit format, bouleau

	cm	↑ cm	€
00880	20 x 12	3	8,80
00881	30 x 20	3	10,40
00882	40 x 15	3	13,40

Wachspapier „SNACKHOLDER“ / greaseproof paper squares
papel alimenticio para cucurucho / papier alimentaire pour cornet

	cm	pcs.	€
40670	42 x 25	500 Motiv: Zeitung	57,00
40671	42 x 25	500 blank	31,00
40672	42 x 25	500 Motiv: rote Karos / red	57,00
40673	42 x 25	500 Motiv: blaue Karos / blue	57,00
40674 NEW	30 x 20	500 Motiv: Fast Food / black	37,00





00867



00868



00869

Servierbrett „AKAZIE-SCHIEFER“

serving board
 tabla de servir
 planche de service

SCHIEFER
 SLATE

HOLZ
 WOOD



raffiniertes, rustikales Servierbrett
 aus Akazienholz, ausgestattet mit einem Naturschieferstreifen
 zur Kennzeichnung

wood with slate, markable
 madera con pizarra, se puede marcar
 bois avec ardoise, on peut mettre une inscription

	cm	↑ cm	€
00867	30,5 x 13,0	1,5	16,00
00868	36,5 x 15,0	1,5	20,00
00869	42,0 x 18,0	1,5	23,00



00870



00873

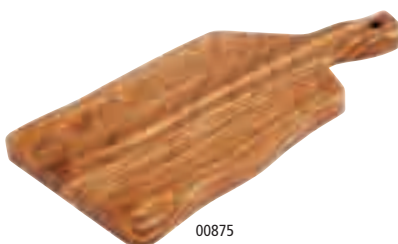

00875

Servierbrett „OLIVE“

serving board
 tabla de servir en madera de olivo
 planche de service en bois d'olivier

HOLZ
 WOOD



Servierbrett im Naturschnitt, aus Olivenholz. Jedes Brett wird handgefertigt und lackiert mit 19 mm Aufhäng Bohrung. Alle Produkte unterscheiden sich naturbedingt in Form, Maserung und Größe!

Olive Wood is known for its versatility and striking appearance with each piece having its own unique features.

El olivo es conocido por su versatilidad y aspecto espectacular y único en cada pieza. Por su fabricación a mano de forma artesanal, todas las piezas varían en tamaño, forma y acabado, lo que hace de cada una un ejemplar único.

Le bois d'olivier est reconnu pour sa versatilité et son esthétique spectaculaire. De par leur fabrication artisanale à la main, toutes les pièces varient quant à leur taille, forme et finition, de telle sorte que chacune est un exemplaire unique.

	cm	↑ cm	Griff / handle cm	€
00870	25,0 x 17,0	1,5		28,00
00871	30,0 x 20,5	2,0		46,00
00872	35,0 x 24,0	2,0		56,00
00873	40,0 x 15,0	1,5	11	49,00
00874	44,0 x 20,0	2,0	12	64,00
00875	19,0 x 12,5	1,5	6	20,00
00876	25,0 x 16,0	1,5	8	30,00
00877	31,0 x 20,0	1,5	9	46,00

Buffet & Display



Rindenholtzbrett

wood plater
tabla de madera con corteza
planche en bois avec écorce



Akazienholz mit Rinde, jedes Brett ein Unikat, vor dem Erstgebrauch mit Speiseöl behandeln
acacia wood with bark, each board unique, treat with cooking oil before first use
madera de acacia con corteza, cada tabla un ejemplar único, tartar con aceite de cocina antes del primer uso
bois d'acacia avec écorce, chaque planche une modèle unique, traiter avec de l'huile de caisson avant la première utilisation

	cm	↑ cm	€
00895	26,0 x 24,0	2	12,00
00896	30,0 x 28,5	2	14,00



Buffetbrett „XXL“

board
tabla para el buffet
planche à découper buffet



Buchenholz geölt, mit Antirutsch-Füßchen
beech wood oiled, with non-slip feet
madera de haya tratada con aceite, con pies antideslizantes
bois hêtre huilé, avec pieds antidérapants

	Ø cm	↑ cm	€
00866	50	4,5	74,00

Rolltophaube / rolltop cover / campana rolltop / cloche rolltop

	Ø cm	↑ cm	€
18380	50	26	21,00



Brezel- oder Wurstständer

pretzel-/ sausage stand
soporte para embutidos
support à bretzel ou à saucissons



Verkaufsständer Buchen-Holz versiegelt, bestens geeignet für die Präsentation von Brezeln, Würstchen, etc., Fuß Ø 22 cm
beech wood, ideal to present pretzels, sausages, etc.
madera de haya, ideal para presentar fiambres, salchichones etc.
en hêtre, idéal pour bretzels ou saucissons, etc.

	Ø cm	↑ cm	€
79553	28	50	19,00

Hygieneschutz für Brezelständer / hygienic cover / cubierta higiénica antialiento / pare-haleine

	cm	↑ cm	€
11557	20 x 20 x 20	50	21,00
11558	15 x 20 x 15	50	19,00



Hobel für Käse und Schokolade

cheese / choco curler
rizador para queso y chocolate
frisette pour fromage et chocolat



3-teilig: Platte Buchen-Holz versiegelt Ø 22 cm mit senkrechtem Stift + Hobel 7 cm + Haube Ø 15 x 10 cm, für Käse und Schokolade

3 pcs. set: wooden base Ø 22 cm with vertical bolt + plough 7 cm + cover Ø 15 x 10 cm, for cheese and chocolate

set de 3 piezas: base de madera Ø 22 cm, con eje vertical de 7 cm + campana Ø 15 x 10 cm, para „rizar“ queso y chocolate

set 3 pièces pour „friser“ le fromage ou le chocolat: base bois Ø 22 cm, axe vertical ht. 7 cm, cloche Ø 15 x ht 10 cm

	Ø cm	↑ cm	€
50002	22	15	16,00



GN Tablett „FRAMES“

GN tray
GN bandeja
GN plateau



	cm	↑ cm	GN	€
82355	53,0 x 32,5	2	1/1	33,00
82356	32,5 x 26,5	2	1/2	19,00
82357	32,5 x 17,6	2	1/3	16,00



GN Tablett

GN tray
GN bandeja
GN plateau



	cm	↑ cm	GN	€
82201	53,0 x 32,5	2,5	1/1	33,00
82202	32,5 x 26,5	2,5	1/2	19,00
82203	32,5 x 17,6	2,5	1/3	16,00
82204	53,0 x 16,2	2,5	2/4	26,00
82205	35,4 x 32,5	2,5	2/3	28,00

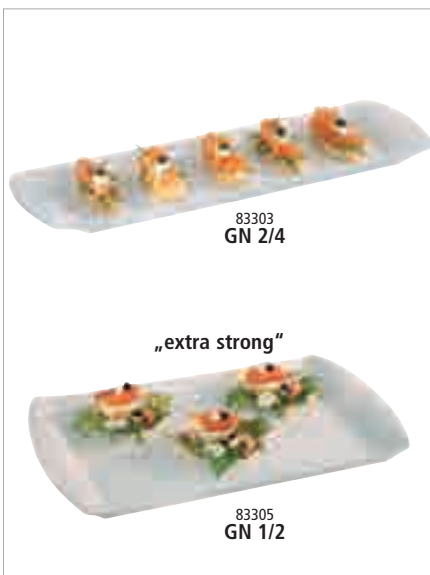

GN Servier-/Buffetplatte

GN dish
GN bandeja bufé
GN plat buffet



	cm	↑ cm	GN	€
83301	53,0 x 32,5	2	1/1	42,00
83305	32,5 x 26,5	2	1/2	25,80
83304	32,5 x 17,5	2	1/3	16,00
83303	53,0 x 16,2	2	2/4	29,00



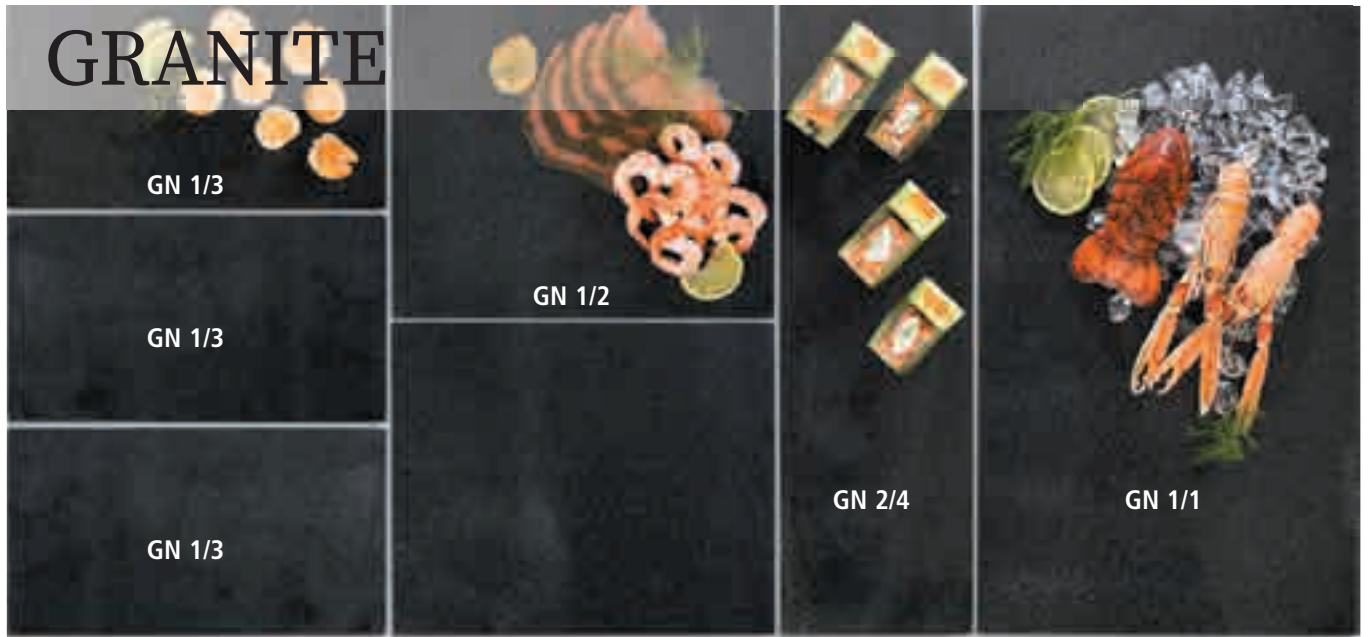

Die Serie „GRANITE“ aus Naturstein, überzeugt durch eine hervorragende Kälte-speicherung.

The new collection „GRANITE“ impresses with its natural stone-made trays, which have an excellent cold storage.

La nueva serie „GRANITE“ impresiona con sus bandejas de piedra natural que conservan el frío excelentemente.

La nouvelle série „GRANITE“ impressionne par ses plateaux en pierre naturelle, qui ont un excellent maintien du froid.



GN Tablett „GRANITE“

GN tray
GN bandeja
GN plateau



	cm	mm	GN	€
00920	53,0 x 32,5	16	1/1	22,00
00921	32,5 x 26,5	16	1/2	17,00



GN Tablett „GRANITE“

GN tray
GN bandeja
GN plateau



	cm	mm	GN	€
00922	32,5 x 17,6	16	1/3	14,00



GN Tablett „GRANITE“

GN tray
GN bandeja
GN plateau



	cm	mm	GN	€
00923	53,0 x 16,2	16	2/4	17,00

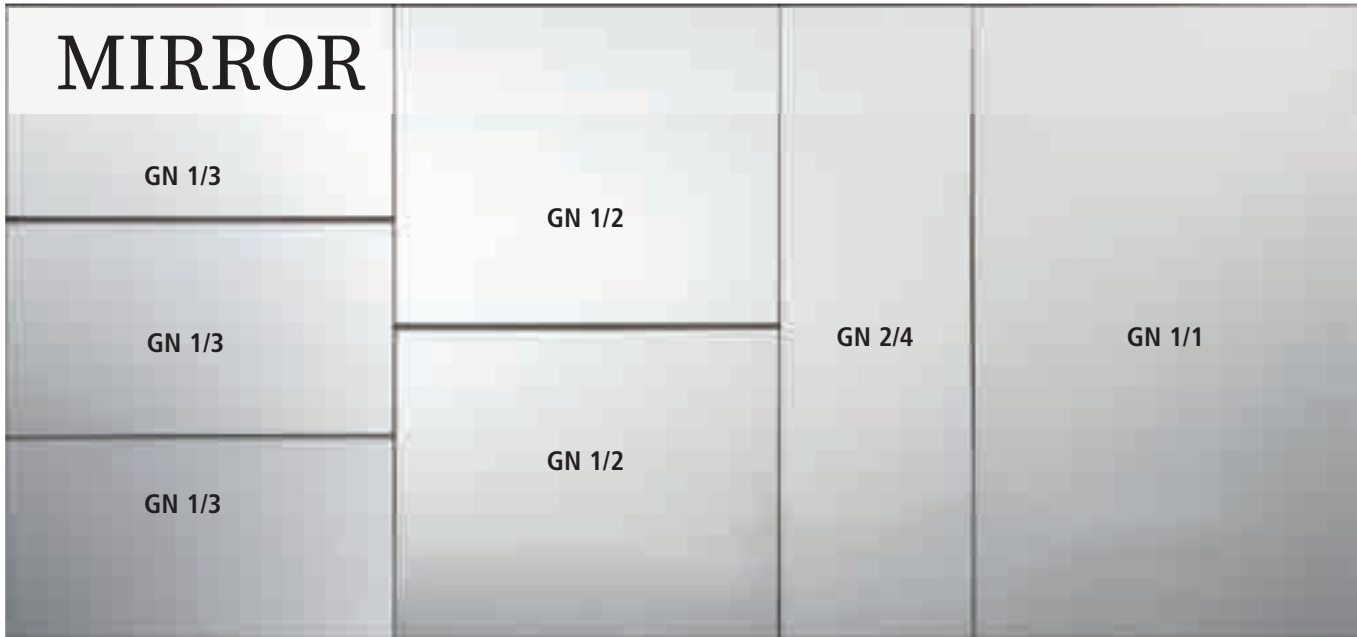

GN Glasplatte „MIRROR“

GN glass platter
GN espejos sobre vidrio
GN plateau miroir en verre



silber spiegelndes Glas, mit Antirutsch-Füßchen
silver mirror glas, non-slip feet
espejo plateado, pies antideslizantes
plateau miroir argenté, pieds antiglisse

	cm	↑ cm	GN	€
00961	53,0 x 32,5	3	1/1	23,00
00962	32,5 x 26,5	3	1/2	12,00
00963	32,5 x 17,6	3	1/3	10,50
00964	53,0 x 16,2	3	2/4	11,50



ZERO

GN Tablett „ZERO“

GN tray
GN bandeja
GN plateau

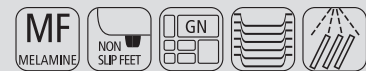

glatte, hochglänzende Oberfläche
smooth and shiny surface
superficie lisa con acabado brillante
surface lisse et finition brillante

	cm	↑ cm	GN	Farbe / Colour	€
84185	53,0 x 32,5	1,5	1/1	▬	34,00
84186	32,5 x 26,5	1,5	1/2	▬	18,20
84187	32,5 x 17,6	1,5	1/3	▬	12,80
84188	26,5 x 16,2	1,5	1/4	▬	10,40
84189	53,0 x 16,2	1,5	2/4	▬	20,00
84195	53,0 x 32,5	1,5	1/1	▬	34,00
84196	32,5 x 26,5	1,5	1/2	▬	18,20
84197	32,5 x 17,6	1,5	1/3	▬	12,80
84198	26,5 x 16,2	1,5	1/4	▬	10,40
84199	53,0 x 16,2	1,5	2/4	▬	20,00



00510

Serviertablett „HAPPY HOUR“

tray
bandeja
plateau



rutschfeste Oberfläche
non-slip surface
superficie anti-deslizante
surface antidérapante

	Ø cm	↑ cm	Farbe / Colour	€
00510	32	1,5	■	20,60
00511	38	1,5	■	25,00
00515	43	1,5	■	28,90



00548

Tablett „GASTRO“

tray
bandeja
plateau



rutschfeste Oberfläche
non-slip surface
superficie anti-deslizante
surface antidérapante

	Ø cm	↑ cm	Farbe / Colour	€
00547	27,5	2	■	6,90
00548	35,5	2	■	8,70
00549	40,5	2	■	10,50



Tablett „BISTRO“

tray
bandeja
plateau



rutschfest, mit 2 Griffmulden und Stapelrand
non-slip, two open handles, stackable edge
anti-deslizante, 2 asas
antidérapant, 2 anses

	Ø cm	↑ cm	Farbe / Colour	€
84045	35,5	4,5	■	22,00



00500

00507

Bierglasträger „RUTSCHFEST“

beer rack
bandeja para cerveza
porte verre à bière



rutschfeste Oberfläche
non-slip surface
superficie anti-deslizante
surface antidérapante

	Ø cm	↑ cm	Farbe / Colour	€	
00500	36	3,5	■	rund / round	19,00
00501	36	3,5	■	rund / round	19,00

	cm	↑ cm	Farbe / Colour	€	
00506	28 x 20	1,5	■	oval	8,50
00507	28 x 20	1,5	■	oval	8,50



Teller mit Glashalter „COCKTAIL“

plate with glass holder
plato sujeta copas
assiette porte-verre



eignet sich besonders für Stehempfänge, einhändig nutzbar
particularly suitable for standing receptions, single-handed use
para uso en recepciones de pie, facil de usar con sólo una mano
particulièrement pour des receptions debout, utilisable avec une seule main

	→ cm	↑ cm	€
84620	22 x 14	1,5	3,00



	Ø cm	↑ cm	€
84621	19	1,5	3,00



Serviertablett „RUTSCHFEST“

tray non-slip
bandeja
plateau



rutschfeste Oberfläche
non-slip surface
superficie antideslizante
surface antidérapante

	cm	↑ cm	GN	Farbe / Colour	€
00502	53,0 x 32,5	1,5	1/1	■	21,90
00508	46,0 x 36,0	2		■	20,80
00505	53,0 x 32,5	1,5	1/1	■	21,90
00503	53,0 x 37,0	1,5		■	25,00



Tablett

tray
bandeja
plateau



rutschfest, Holzdekor-Laminat
non-slip, coated wood
antideslizante, decoración madera láminae
antidérapant, décor bois laminé

	cm	↑ cm	€
00524	43,5 x 31,5	1,5	17,20
00525	52,0 x 39,0	1,5	21,80
00526	60,5 x 42,5	1,5	27,50

Buffet & Display



Fast Food-Tablett

snack tray
bandeja autoservicio y snacks
plateau self-service et snacks



	cm	↑ cm	GN	Farbe / Colour	€
00530	35 x 27	2			3,10
00535	41 x 30,5	2			4,10
00540	45 x 35,5	2			5,10
00552	53,0 x 32,5	2	1/1		6,20

	cm	↑ cm	GN	Farbe / Colour	€
00531	35 x 27	2			3,10
00536	41 x 30,5	2			4,10
00541	45 x 35,5	2			5,10
00553	53,0 x 32,5	2	1/1		6,20

	cm	↑ cm	GN	Farbe / Colour	€
00532	35 x 27	2			3,10
00537	41 x 30,5	2			4,10
00542	45 x 35,5	2			5,10
00554	53,0 x 32,5	2	1/1		6,20

	cm	↑ cm	GN	Farbe / Colour	€
00533	35 x 27	2			3,10
00538	41 x 30,5	2			4,10
00543	45 x 35,5	2			5,10
00555	53,0 x 32,5	2	1/1		6,20



Tablett

tray
bandeja
plateau



rutschfest, Mahagonifurnier
non-slip, woodform, mahogany
antideslizante
antidérapant

	Ø cm	↑ cm		€
00528	31	3,5	hoher Rand	17,20
00529	35,5	3,5	hoher Rand	21,90



Tablett

tray
bandeja
plateau



rutschfest, Holzdekor-Laminat
non-slip, coated wood
antideslizante
antidérapant

	cm	↑ cm		€
00520	23,0 x 16,0	1,0		7,40
00521	26,0 x 20,0	1,0		7,60
00522	29,0 x 21,0	1,0		9,90
00523	38,0 x 27,0	1,5		14,20



Rechnungstablett, 2er Set

bill presenter, 2 pcs. set
 porta cuenta, set de 2 unidades
 porte-addition, set de 2 pièces



1 Edelstahl-Tablett hochglanzpoliert + 1 klappbare Ledermappe mit Stifflasche, mit Magnethalterung

1 stainless tray mirror polished finish + 1 leather presenter, with magnetic system
 1 bandeja de acero inoxidable pulido brillante + 1 presentador de cuero con sistema magnético
 1 plateau inox poli brillant + 1 pochette cuir aimantée

	cm	↑ cm	€
30109	20 x 16	2	24,40



Rechnungstablett

bill presenter
 porta cuenta
 porte-addition



mit Klemme für Rechnung

with clip for bill
 con clip para la nota
 avec clip pour la note

	cm	↑ cm	€
30108	20,0 x 12,0	0,5	1,70



Rechnungstablett

bill presenter
 porta cuenta
 porte-addition



mit Klemme für Rechnung

with clip for bill
 con clip para la nota
 avec clip pour la note

	cm	↑ cm	€
30110	17 x 11	1	5,80



Untersetzer

coaster
 posavasos
 plateau sous-verre



hochglanzpoliert, schwere Ausführung, Rand eingerollt
 mirror polished finish, heavy quality, rolled edge
 acabado pulido efecto espejo, alta calidad, borde redondeado
 effet miroir, bord rond, qualité extra

	Ø cm	pcs.	€
35711	10	6	15,00
35912	12	6	13,90

35912

Rand eingerollt

Buffet & Display



Tablett

tray
bandeja
plateau

mit gebördeltem, polierten Rand
rolled and mirror polished edge
borde redondeado acabado efecto espejo
bord rond, effet miroir



	Ø cm	↑ cm		€
01336	35	3		26,00



Buffetständer

buffet stand
soporte bufé
support buffet



	Ø cm	↑ cm	fits to	€
74207	20 - 25	19	01336	11,00



Bratenplatte „ECO LINE“

meat platter
fuente servicio
plat de service

poliert, Rand eingerollt
polished, rolled edge
pulido, borde redondeado
poli miroir, bord rond



	cm	€
30101	30 x 22	9,00
30102	35 x 22	11,00
30103	40 x 26	16,20
30104	45 x 30	19,00



Servierpfanne

pan
fuente para la mesa
plat pour la table

mit vergoldeten Edelstahl-Griffen, 1 mm dick
with gold plated handles, 1 mm thickness
grosor 1 mm., asas doradas
épaisseur 1 mm, poignées dorées



	cm	↑ cm	litr.	€
61190	19	3,5	0,7	14,20
61280	28	4	2	20,00
61400	40	5	4,5	54,60



Servierpfanne

pan
fuente para la mesa
plat pour la table

mit vergoldeten Edelstahl-Griffen, 1 mm dick
with gold plated handles, 1 mm thickness
grosor 1 mm., asas doradas
épaisseur 1 mm, poignées dorées



	cm	↑ cm	litr.	€
60270	26,5 x 19,5	3	0,8	15,80
60310	31 x 21,5	3	1,2	19,40



Tablett „TREND“

baking sheet
bandeja
plateau



ein Backblech wird zum Serviertablett

a baking sheet which becomes a serving tray

Una bandeja de hornear que se convierte en una bandeja de servir

Un moule qui devient un plateau de service

	cm	↑ cm	€
13380	32,0 x 21,5	2	8,00



Tablett „TIMBER“

tray
bandeja
plateau



die Melaminplatten (Holzoptik Fichte) haben eine leichte Struktur und wirken optisch wie aus Holz gefertigt

the melamine trays (superb spruce wood effect – timber) have a lightweight structure and look visually as made of wood

las bandejas de melamina (imitación madera de picea) tienen una estructura ligera y parecen estar hechas de madera

les plateaux de mélamine (imitation bois d'épicéa) ont une structure légère et donnent une impression visuelle de bois

	cm	↑ cm	€
84269	65 x 26	3	30,00



Tablett „TIMBER“

tray
bandeja
plateau



	cm	↑ cm	€
84256	70 x 26	3	59,00



Tablett „OAK LIGHT“

tray
bandeja
plateau



die Melaminplatten (Holzoptik Eiche) haben eine leichte Struktur und wirken optisch wie aus Holz gefertigt

the melamine trays (superb oak wood effect) have a lightweight structure and look visually as made of wood

las bandejas de melamina (imitación madera de roble) tienen una estructura ligera y parecen estar hechas de madera

les plateaux de mélamine (imitation bois de chêne) ont une structure légère et donnent une impression visuelle de bois

	cm	↑ cm	€
84265	65 x 26	3	30,00



Tablett „OAK LIGHT“

tray
bandeja
plateau



	cm	↑ cm	€
84264	44 x 25	1,5	20,00

Buffet & Display



Servier- / Tortenplatte

cake stand
soporte para pastel
présentoir à gâteaux

hochglanzpoliert, mit hohem Fuß (fest verbunden)
mirror polished finish, with tall foot
acabado brillante, con pie alto
poli brillant, pied haut



	Ø cm	↑ cm	€
00466	34,5	13,5	49,00



Servier- / Tortenplatte

cake stand
soporte para pastel
présentoir à gâteaux

Fuß hochglanzpoliert, Platte matt poliert, stabil und sehr standsicher
foot mirror polished finish, plate satin polished finish
pie pulido brillante, bandeja pulida mate
pied brillant, plateau poli satin mat



	Ø cm	↑ cm	€
00462	30	11	42,00



Servier- / Tortenplatte

cake stand
soporte para pastel
présentoir à gâteaux

matt poliert, drehbar, möbelschonende Moosgummi-Unterseite
satin polished finish, rotating, foam rubber below to save your furniture
acabado pulido satinado, giratorio, base revestida de goma para no rallar el mobiliario
poli satiné, plateau tournant, revêtement mousse sous le pied pour ne pas rayer les meubles



	Ø cm	↑ cm	€
00463	30,5	9	38,00



Servier- / Tortenplatte

cake stand
soporte para pastel
présentoir à gâteaux

Fuß matt poliert, stabil und sehr standsicher, möbelschonende Moosgummi-Unterseite
foot satin polished finish, foam rubber below to save your furniture
pie pulido con efecto satinado, base revestida de goma para no rallar el mobiliario
inox poli satin, revêtement mousse sous le pied pour ne pas rayer les meubles



	Ø cm	↑ cm	€
00464	30	11	18,50

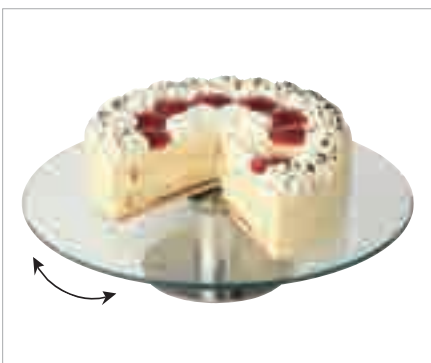

Servier- / Tortenplatte

cake stand
soporte para pastel
présentoir à gâteaux

Fuß matt poliert, drehbar, möbelschonende Moosgummi-Unterseite
foot satin polished finish, rotating, foam rubber below to save your furniture
vidrio, pie inox satinado giratorio, base de goma para proteger el mobiliario
plateau en verre, pied tournant inox poli satin, revêtement mousse sous le pied anti-rayures



	Ø cm	↑ cm	€
00444	30	7	18,90



Torten- / Konditorplatte

cake stand
soporte para pastel
présentoir à gâteaux

Rand fixiert die Haube, mit Antirutsch-Füßchen

carved edge fixes the cover, non-slip feet
ranura para fijar bien la campana, pies antideslizantes
bord rainuré pour maintenir ferme la cloche, pieds antiglisse



	Ø cm	↑ cm	Farbe / Colour	€
00468	31	4		15,00
00469	31	4		15,00

Frischhalte- Haube / cover / campana/ cloche



	Ø cm	↑ cm	fits to	€
06520 <small>NEW</small>	30	22	84242, 84177, 83892, 83891, 83890, 83884, 15303, 998, 975, 469, 468, 463, 462 46,	29,90



Konditorplatte

cake stand
soporte para pastel
présentoir à gâteaux

matt poliert

satin polished finish
acabado efecto satinado
poli mat effet satin



	Ø cm	↑ cm	€
00046	31	3	12,50



Kaviarkühler

caviar cooler
enfriador de caviar
rafraîchisseur de caviar

4-teilig: Glasschale Ø 10 cm

4 pcs.: glass bowl Ø 10 cm

4 piezas: bol Ø 10 cm

4 éléments: bol Ø 10 cm



	Ø cm	↑ cm	€
01699	18	12	49,90



Edelstahlschale, doppelwandig

stainless bowl, double wall
bol inox doble pared
bol inox double paroi

beste Isoliereigenschaften

best insulating properties
muy aislante
très isolant



	Ø cm	↑ cm	ltr.	€
30041	20	9	1,5	23,00

Buffet & Display



DRESSINGTOPF-DISPLAY/-STATION

wooden station for 3 dressing pots
expositor de madera para 3 salseras
présentoir en bois pour 3 pots à sauce

inkl. 3 Beschriftungsschilder aus Metall
incl. 3 metal labels
incl. 3 etiquetas de metal
incl. 3 étiquettes métalliques



	cm	↑ cm	€
84863	40 x 16	9	24,00



passend für 83311, 83867, 30060
suitable for 83311, 83867, 30060



Dressingtopf „PASTELL“

dressing pot
salsera
pot à sauce



	cm	↑ cm	ltr.	Farbe / Colour	€
84862	13	19,5	1,5	Green	19,00
84860	13	19,5	1,5	White	19,00
84861	13	19,5	1,5	Pink	19,00

Beschriftungsetiketten, 72 Stück / labeling labels, 72 pcs. set
etiquetas, 72 pzs / étiquettes, 72 pcs.

	cm	Farbe / Colour	€
00069	8 x 4,6	Black	10,00



mit Antirutschfüßchen
with non-slip feet
con pies antideslizantes
avec pieds antidérapants



stapelbar
stackable
apilable
empilable



Dressingtopf, doppelwandig „PROFI“

dressing pot, double wall
salsera alta, doble pared
pot à sauce, double paroi

beste Isoliereigenschaften
best insulating properties
muy aislante
très isolant



	Ø cm	↑ cm	ltr.	€
30060	13	19	1,4	29,00

Beschriftungsetiketten, 72 Stück / labeling labels, 72 pcs. set
etiquetas, 72 pzs / étiquettes, 72 pcs.

	cm	Farbe / Colour	€
00069	8 x 4,6	Black	10,00



Dressingtopf „CASUAL“
dressing pot
salsera
pot à sauce



	cm	↑ cm	ltr.	Farbe / Colour	€
83867	12	21,5	1,0	■	24,00



Dressingtopf „CASUAL“
dressing pot
salsera
pot à sauce



	cm	↑ cm	ltr.	Farbe / Colour	€
83868	12	21,5	1,0	■	24,00



Dressingtopf, doppelwandig
bowl, double wall
salsera alta, doble pared
pot à sauce, double paroi

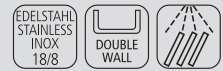

beste Isoliereigenschaften
best insulating properties
muy aislante
très isolant

	Ø cm	↑ cm	ltr.	€
30043	15	18	1,8	41,00



Dressingtopf
dressing pot
salsera
pot à sauce



Deckel mit Löffelaussparung
cover notched for spoon
tapa agujereada para el cucharón
couvercle avec espace pour la louche

	Ø cm	↑ cm	ltr.	€
83309	18,5	17	2,3	22,00
83310	17	15	2,0	21,00
83311	13	13	0,8	11,00



Buffetvitrine

showcase
vitrina de bufé
vitrine de buffet



1 transparente Rolltophaube beidseitig aufklappbar + 1 Schale (ABS)
+ 1 Edelstahl-Tablett 39 x 28 cm + 2 Kühl-Akkus

1 transparent rolltop cover + 1 tray (ABS) + 1 stainless tray 39 x 28 cm + 2 coolers, demountable

1 tapa abatible transparente + 1 bandeja (ABS) + 1 bandeja 39x28cm + 2 enfriadores, desmontable

1 cloche transparente ouverture 2 côtés + 1 caisson (ABS) + 1 plateau inox 39 x 28 cm + 2 accumulateurs de froid, démontable

	cm	↑ cm	Farbe / Colour	€
09100	44 x 32	20,5	White	35,00
09102	44 x 32	20,5	Blue	35,00
09104	44 x 32	20,5	Black	35,00

Kühlakku / cooler / acumulador de frío / accumulateur de froid

	cm	↑ cm	pcs.	€
11101	16 x 7,5	2,0	4	4,70

Edelstahl-Tablett / stainless steel tray / bandeja de acero inoxidable / plateau inox

	cm	€
90902	39 x 28	6,00



Thermo Tablett-Set

thermo tray
bandeja termo
caisson thermo



1 stabile Schale + 1 Edelstahl-Tablett + 2 Kühlakkus + 1 Frischhaltehaube

1 plastic tray + 1 stainless tray + 2 coolers + 1 cover

1 bandeja de plástico + 1 bandeja inox + 2 acumuladores + 1 campana

1 plateau plastique + 1 plateau inox + 2 accumulateurs de froid + 1 cloche

	cm	↑ cm	€
09090	43 x 29	14	19,00

Kühlakku / cooler / acumulador de frío / accumulateur de froid

	cm	↑ cm	pcs.	€
11101	16 x 7,5	2,0	4	4,70

Haube / cover / campana / cloche

	cm	↑ cm	€
90901	43 x 29	14	4,40

Edelstahl-Tablett / stainless steel tray / bandeja de acero inoxidable / plateau inox

	cm	€
90902	39 x 28	5,30

Kühl-Akkus halten Ihre Speisen bis zu 6 Stunden kühl



Buffetvitrine „DOPPELDECKER“

showcase
vitrina de bufé, 2 alturas
vitrine de buffet double



2 transparente Rolltophauben beidseitig aufklappbar + 2 Edelstahl-Tabletts 39 x 28 cm + 4 Kühl-Akkus, platzsparend lagerbar

2 transparent rolltop cover + 2 tray 39 x 28 cm + 4 coolers, demountable, space saving
2 campanas abatibles por ambos lados + 2 bandejas 39 x 28 cm + 4 acumuladores, desmontable, ahorra espacio

2 cloches transparentes abatantés 2 côtés + 2 plateaux 39 x 28 cm + 4 accumulateurs de froid, gain d'espace

	cm	↑ cm	Farbe / Colour	€
09200	44 x 32	44		69,50
09202	44 x 32	44		69,50
09204	44 x 32	44		69,50

Kühlakku / cooler / acumulador de frío / accumulateur de froid

	cm	↑ cm	pcs.	€
11101	16 x 7,5	2,0	4	4,70

Edelstahl-Tablett / stainless steel tray / bandeja de acero inoxidable / plateau inox

	cm	€
90902	39 x 28	5,30



Thermo Tablett-Set

thermo tray
bandeja termo
caisson thermo



1 stabile Schale + 1 Edelstahl-Tablett + 2 Kühlakkus + 1 Frischhaltehaube

1 plastic tray + 1 stainless tray + 2 coolers + 1 cover

1 bandeja de plástico + 1 bandeja inox + 2 acumuladores + 1 campana

1 plateau plastique + 1 plateau inox + 2 accumulateurs de froid + 1 cloche

	Ø cm	↑ cm	€
09093	35	15	19,00

Kühlakku / cooler / acumulador de frío / accumulateur de froid

	cm	↑ cm	pcs.	€
11101	16 x 7,5	2,0	4	4,70

Kühl-Akkus halten Ihre Speisen bis zu 6 Stunden kühl

Buffet & Display

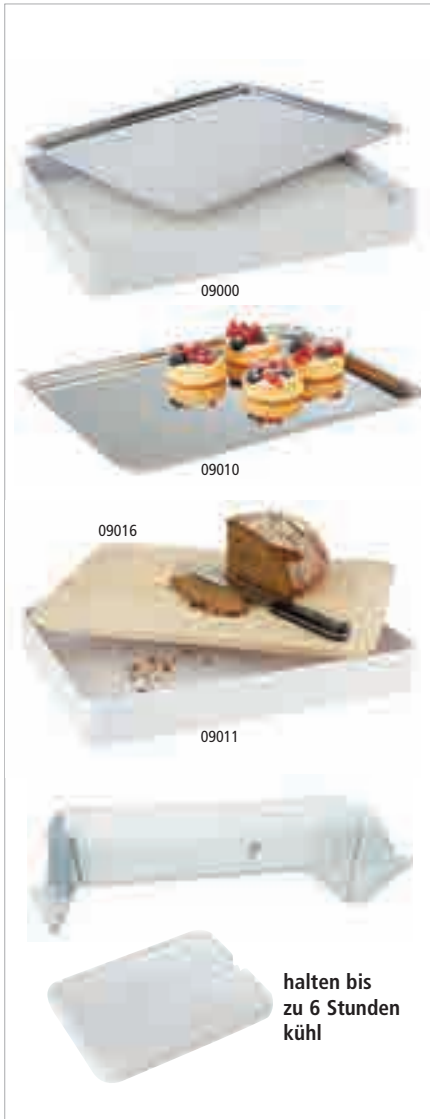

Buffet-Set „FOCUS“

buffet set
set de bufé
présentoir pour le buffet

4-teilig: Box, Tablett, 2 Kühlakkus

4 pcs.: box, tray, 2 cooler

4 piez.: box, bandeja, 2 enfriadores

4 éléments: caisson, 2 plateau, bac



	cm	↑ cm	Farbe / Colour	€
09000	43,5 x 32,5	6	White	54,00
09001	43,5 x 32,5	6	Black	54,00

Edelstahltablett / tray / bandeja / plateau

	cm	↑ cm	€
09010	43,5 x 32,5	1,5	19,00

Holzschneidebrett / wooden board / tablero de madera / planche à découper

	cm	↑ cm	€
09016	43,5 x 32,5	2	46,50

Basisteil / base / base / base

	cm	↑ cm	Farbe / Colour	€
09011	42,5 x 31,5	6	White	22,00
09012	42,5 x 31,5	6	Black	22,00

Rolltophaube „PURE“ / rolltop cover / campana abatible / cloche basculante

	cm	↑ cm	€
09013	44 x 33,5	17	24,00

Kühlakku / cooler / acumulador de frío / accumulateur de froid

	cm	↑ cm	€
10791	25 x 19	2,5	7,20



Buffet-Set „FOCUS“

buffet set
set de bufé
présentoir pour le buffet

3-teilig: Box, Tablett, 1 Kühlakku

3 pcs.: box, tray, 1 cooler

3 piez.: box, bandeja, 1 enfriador

3 éléments: caisson, 1 plateau, bac



	Ø cm	↑ cm	Farbe / Colour	€
09002	38	6	White	40,00
09003	38	6	Black	40,00

Edelstahltablett / tray / bandeja / plateau

	Ø cm	↑ cm	€
09020	38	1,5	15,00

Basisteil / base / base / base

	Ø cm	↑ cm	Farbe / Colour	€
09021	37	6	White	19,00
09022	37	6	Black	19,00

Rolltophaube / rolltop cover / campana abatible / cloche basculante

	Ø cm	↑ cm	€
09023	38	20	19,00



Buffetvitrine „TOP FRESH GN 1/1“
refrigerated buffet display
expositor bufé frío
plateau buffet froid



4-teilig: 1 Holzbox mit Kunststoffwanne + 1 Tablett GN 1/1 + 2 Kühllakku
4 pcs. set: 1 woodbox with plastic insert + 1 stainless tray GN 1/1 + 2 coolers
set de 4 piezas: 1 base madera + 1 bandeja inox GN 1/1 + 2 acumuladores de frío
set de 4 pièces: 1 base bois + 1 plateau inox GN 1/1 + 2 accus de froid (cloche non incluse)

	cm	↑ cm	€
11540	60 x 41	5	174,00

GN Rolltophaube / GN rolltop cover / GN campana rolltop / GN cloche rolltop

	cm	↑ cm	GN	€
11008	53,0 x 32,5	19	1/1 Gold-Griff	59,90

GN Rolltophaube / GN rolltop cover / GN campana rolltop / GN cloche rolltop

	cm	↑ cm	GN	€
11010	53,0 x 32,5	19	1/1 Chrom-Griff	59,90

Kühllakku / cooler / acumulador de frío / accumulateur de froid

	cm	↑ cm	€
10791	25 x 19	2,5	7,20



Buffetvitrine „DOPPELDECKER“
cooling buffet display
expositor bufé frío
vitrine buffet



12-teilig: 2 Kästen Buchen-Holz versiegelt + 2 Tablett GN 1/1 + 4 Kühllakku + 4 Stangen, ohne Hauben

12 pcs. set: 2 beech wood boxes waterproof + 2 trays GN 1/1 + 4 coolers + 4 fittings, without covers

set de 12 piezas: 2 bases madera tratada + 2 bandejas inox GN 1/1 + 4 enfriadores + 4 pies (campanas no incl.)

set de 12 pièces: 2 caissons bois traité (hêtre) + 2 plateaux inox GN 1/1 + 4 accus + 4 pieds (cloches non incluses)

	cm	↑ cm	€
11541	60 x 41	36	329,00

verchromte Stäbe / chrome plated fittings
pies cromados / pieds chromés

GN Rolltophaube / GN rolltop cover / GN campana rolltop / GN cloche rolltop

	cm	↑ cm	GN	€
11008	53,0 x 32,5	19	1/1 Gold-Griff	59,90

GN Rolltophaube / GN rolltop cover / GN campana rolltop / GN cloche rolltop

	cm	↑ cm	GN	€
11010	53,0 x 32,5	19	1/1 Chrom-Griff	59,90

Kühllakku / cooler / acumulador de frío / accumulateur de froid

	cm	↑ cm	€
10791	25 x 19	2,5	7,20

Buffet & Display



Kühltablett „TOP FRESH RUND“

refrigerated buffet display
expositor bufé frío redondo
présentoir buffet



3-teilig: 1 Holzbox mit Kunststoffwanne + 1 Edelstahl-Tablett Ø 38 cm + 1 Kühlakku

3 pcs. set: 1 woodbox with plastic insert + 1 stainless tray Ø 38 cm + 1 cooler

set de 3 piezas: 1 caja madera + 1 bandeja inox Ø 38 cm + 1 acumulador de frío

set de 3 pièces: 1 base bois + 1 plateau inox Ø 38 cm + 1 accumulateur de froid

	Ø cm	↑ cm	cl	€
11542	48	6		174,00

Rolltophaube / rolltop cover / campana abatible / cloche basculante

	Ø cm	↑ cm		€
18388	38	20	mit verchromtem Kugelgriff	19,40

Rolltophaube / rolltop cover / campana abatible / cloche basculante

	Ø cm	↑ cm		€
18387	38	20	mit vergoldetem Kugelgriff	19,40

Kühlakku / cooler / acumulador de frío / accumulateur de froid

	cm	↑ cm	€
10791	25 x 19	2,5	7,20



Buffetvitrine „DOPPELDECKER“

double refrigerated buffet display
expositor de bufé redondo doble
présentoir buffet froid, double



11-teilig: 2 Rahmen Buchen-Holz versiegelt + 2 Edelstahl-Tablets Ø 38 cm

+ 2 Kühlakkus + 2 Kunststoffschalen + 3 Stangen, ohne Hauben

11 pcs. set: 2 beech wood boxes waterproof + 2 stainless trays Ø 38 cm

+ 2 cooler + 2 plastic deep trays + 3 fittings, without covers

set de 11 piezas: 2 bases madera + 2 bandejas inox aprox. 38cm

+ 2 acumuladores + 2 cubetas plástico + 3 varas (campanas no incl.)

set de 11 pièces: 2 caissons bois traité (hêtre) + 2 plateaux inox approx. 38 cm

+ 2 accus + 2 bacs plastique + 3 barres (cloches non incluses)

	Ø cm	↑ cm		€
11543	48	38	verchromte Stäbe / chrome fittings pies cromados / pieds chromés	289,00

Rolltophaube / rolltop cover / campana abatible / cloche basculante

	Ø cm	↑ cm		€
18388	38	20	mit verchromtem Kugelgriff	19,40

Rolltophaube / rolltop cover / campana abatible / cloche basculante

	Ø cm	↑ cm		€
18387	38	20	mit vergoldetem Kugelgriff	19,40

Kühlakku / cooler / acumulador de frío / accumulateur de froid

	cm	↑ cm	€
10791	25 x 19	2,5	7,20



Buffetvitrine „TOP FRESH GN 1/1“

cooling buffet display
expositor bufé frío
présentoir buffet



5-teilig: 1 Edelstahl-Tablett GN 1/1 + 2 Kühllakku + 1 Edelstahl-Schale + 1 Acrylrahmen, ohne Haube

5 pcs. set: 1 stainless tray GN 1/1 + 2 cooler + 1 stainless deep tray + 1 frame acrylic, without cover

set de 5 piezas: 1 bandeja inox GN 1/1 + 2 acumuladores + 1 cubeta inox + 1 marco metacrilato (campana no incl.)

set de 5 pièces: 1 plateau inox GN 1/1 + 2 accus. de froid + 1 bac inox + 1 cadre plexi (cloche non-incl.)

	cm	↑ cm	€
11510	61 x 38	8	210,00

GN Rolltophaube / GN rolltop cover / GN campana rolltop / GN cloche rolltop

	cm	↑ cm	GN	€
11010	53,0 x 32,5	19	1/1	59,90

Kühllakku / cooler / acumulador de frío / accumulateur de froid

	cm	↑ cm	€
10791	25 x 19	2,5	7,20

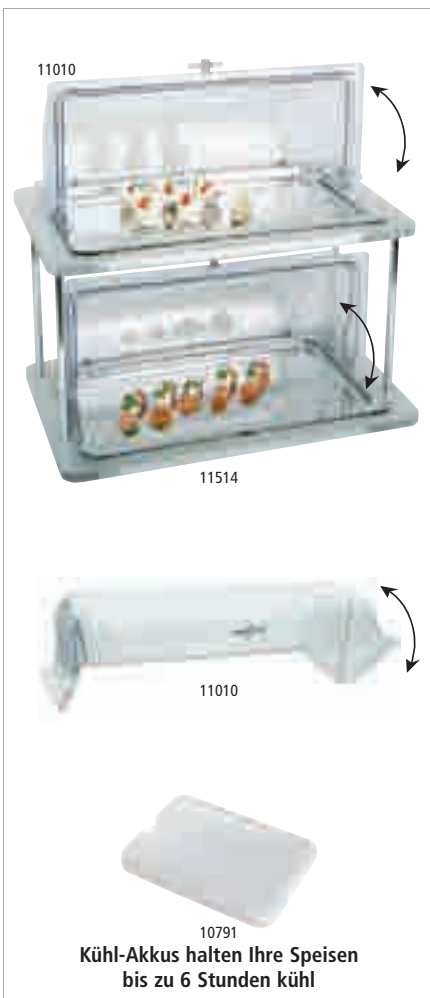

Buffetvitrine „DOPPELDECKER GN1/1“

cooling buffet display
expositor bufé frío
présentoir buffet



14-teilig: 2 Edelstahl-Tablets GN 1/1 + 4 Kühllakku + 2 Edelstahl-Schale + 2 Acrylrahmen + 4 verchromte Stangen, ohne Hauben

14 pcs. set: 2 stainless tray GN 1/1 + 4 cooler + 2 stainless deep trays + 2 frames acrylic + 4 chrome plated fittings, without covers

set de 14 piezas: 2 bandejas inox GN 1/1 + 4 acum. de frío 2 cubetas inox + 2 bases metacrilato + 4 varas cromadas (sin las campanas)

set de 14 pièces: 2 plateaux inox GN 1/1 + 4 accus 2 bacs inox + 2 cadres plexi + 4 barres chromées (sans les cloches)

	cm	↑ cm	€
11514	61 x 38	33	379,00

GN Rolltophaube / GN rolltop cover / GN campana rolltop / GN cloche rolltop

	cm	↑ cm	GN	€
11010	53,0 x 32,5	19	1/1	59,90

Kühllakku / cooler / acumulador de frío / accumulateur de froid

	cm	↑ cm	€
10791	25 x 19	2,5	7,20

Buffet & Display



Kühltablett „TOP FRESH RUND“

cooling plate
expositor bufé frío
présentoir buffet



4-teilig: 1 Edelstahl-Tablett Ø 38 cm + 2 Kühlakkus + 1 Edelstahl-Schale + 1 Acrylrahmen, ohne Haube

4 pcs. set: 1 stainless tray Ø 38 cm + 2 cooler + 1 stainless deep tray + 1 frame acrylic, without cover

set de 4 piezas: 1 bandeja inox 38cm + 2 acum. de frío + 1 cubeta inox + 1 base metacrilato (campana no incluida)

set de 4 pièces: 1 plateau inox 38cm + 2 accum. de froid + 1 bac inox + 1 base plexi (cloche non incl.)

	Ø cm	↑ cm	€
11512	43,5	8	174,00

Rolltophaube / rolltop cover / campana abatible / cloche basculante

	Ø cm	↑ cm		€
18388	38	20	mit verchromtem Kugelgriff	19,40

Kühlakku / cooler / acumulador de frío / accumulateur de froid

	cm	↑ cm	pcs.	€
11101	16 x 7,5	2,0	4	4,70



Buffetvitrine „DOPPELDECKER“

cooling plate
expositor de bufé doble redondo
présentoir buffet



13-teilig: 2 Edelstahl-Tabletts Ø 38 cm + 4 Kühlakkus + 2 Edelstahl-Schalen + 2 Acrylrahmen + 3 verchromte Stangen, ohne Hauben

13 pcs. set: 2 stainless trays Ø 38 cm + 4 cooler + 2 stainless deep tray + 2 frames acrylic + 3 chrome plated fittings, without covers

set de 13 piezas: 2 bandejas inox 38 cm + 4 acumuladores de frío + 3 varas cromadas + 2 bases + 2 bandejas, campana no incluida

set de 13 pièces: 2 plateaux inox 38cm + 4 accum. de froid + 2 bacs inox + 2 bases plexi + 3 barres chromées (cloche non incl.)

	Ø cm	↑ cm	€
11516	43,5	33	324,00

Rolltophaube / rolltop cover / campana abatible / cloche basculante

	Ø cm	↑ cm		€
18388	38	20	mit verchromtem Kugelgriff	19,40

Kühlakku / cooler / acumulador de frío / accumulateur de froid

	cm	↑ cm	pcs.	€
11101	16 x 7,5	2,0	4	4,70

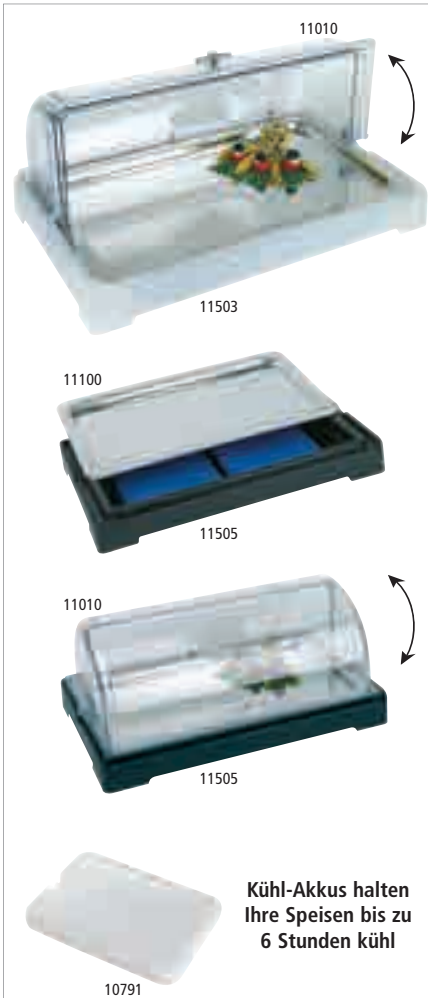

Kühlbox „TOP FRESH GN 1/1“

cooling plate
bandeja de frío
présentoir buffet réfrigéré



4-teilig: 1 Kühlbox + 1 Tablett GN 1/1 + 2 Kühlakkus, ohne Haube

4 pcs. set: 1 box + 1 tray GN 1/1 + 2 coolers, without cover

set de 4 piezas: 1 caja plástico blanco + 1 bandeja GN 1/1 + 2 acum. de frío, campana no incluida

set de 4 pièces: 1 caisson plastique blanc + 1 plateau GN 1/1 + 2 accum. de froid, cloche non incl.

	cm	↑ cm	Farbe / Colour	€
11503	56,5 x 35	6,5		94,00
11505	56,5 x 35	6,5		94,00

GN Rolltophaube / GN rolltop cover / GN campana rolltop / GN cloche rolltop

	cm	↑ cm	GN	€
11008	53,0 x 32,5	19	1/1 mit vergoldetem Kreuzgriff	59,90

GN Rolltophaube / GN rolltop cover / GN campana rolltop / GN cloche rolltop

	cm	↑ cm	GN	€
11010	53,0 x 32,5	19	1/1 mit verchromtem Kreuzgriff	59,90

Kühlakku / cooler / acumulador de frío / accumulateur de froid

	cm	↑ cm	€
10791	25 x 19	2,5	7,20

GN Edelstahl-Tablett „PROFI LINE“ / GN tray / GN bandeja / GN plat empilable système catering

	cm	↑ cm	GN	€
11100	53,0 x 32,5	1,5	1/1	27,00

Kühl-Akkus halten Ihre Speisen bis zu 6 Stunden kühl

In der Box sorgt der Kühlakku für eine beständige Frische für Wurst, Käse, etc.



Kühlbox „TOP FRESH GN 1/1“

cooling box
expositor buffet frío
présentoir buffet



4-teilig: 1 Kühlbox + 1 Tablett GN 1/1 + 2 Kühlakkus, ohne Haube

4 pcs. set: 1 box + 1 tray GN 1/1 + 2 cooler, without rolltop cover

set de 4 piezas: 1 cajón + 1 bandeja GN 1/1 + 2 enfriadores, campana no incluida

set de 4 pièces: 1 caisson inférieur + 1 plateau GN 1/1 + 2 accus, cloche non incluse

	cm	↑ cm	€
11590	56,5 x 36	8,5	220,00

GN Rolltophaube / GN rolltop cover / GN campana rolltop / GN cloche rolltop

	cm	↑ cm	GN	€
11008	53,0 x 32,5	19	1/1	59,90

GN Rolltophaube / GN rolltop cover / GN campana rolltop / GN cloche rolltop

	cm	↑ cm	GN	€
11010	53,0 x 32,5	19	1/1	59,90

Kühlakku / cooler / acumulador de frío / accumulateur de froid

	cm	↑ cm	€
10791	25 x 19	2,5	7,20

Schneidebrett / cutting board / tabla de corte / planche à découper

	cm	↑ cm	€
00901	47,5 x 26,5	1	27,50

Kühl-Akkus halten Ihre Speisen bis zu 6 Stunden kühl



Kühlbox „TOP FRESH SET“

cooling plate
bandeja de frío
set réfrigère



3-teilig: 1 Box + 1 Tablett Ø 38 cm + 1 Kühlakku, ohne Haube

3 pcs. set: 1 box + 1 tray Ø 38 cm + 1 cooler, without cover

set de 3 piezas: 1 caja + 1 bandeja Ø 38 cm + 1 enfriador, sin tapa

set de 3 pièces: 1 caisson + 1 plateau Ø 38 cm + 1 accum. (livré sans la cloche)

	Ø cm	↑ cm	Farbe / Colour	€
11538	42	6	White	77,00
11533	42	6	Black	77,00

Rolltophaube / rolltop cover / campana abatible / cloche basculante

	Ø cm	↑ cm		€
18388	38	20	mit verchromtem Kugelgriff	19,40

Kühlakku / cooler / acumulador de frío / accumulateur de froid

	cm	↑ cm		€
10791	25 x 19	2,5		7,20



Thermo-Set

thermo set
bandeja isotérmica
set thermo



5-teilig: 1 Tablett tief + 1 Tablett flach + 2 Kühlakkus + 1 Rolltophaube

5 pcs. set: 1 deep tray + 1 tray + 2 cooler + 1 rolltop cover

set de 5 piezas: 1 bandeja inferior + 1 bandeja + 2 acumuladores frío + campana

set de 5 pièces: 1 plateau creux + 1 plateau plat + 2 accum. + 1 cloche rolltop

	Ø cm	↑ cm		€
09082	38	24		50,00

Rolltophaube / rolltop cover / campana abatible / cloche basculante

	Ø cm	↑ cm		€
18388	38	20	mit verchromtem Kugelgriff	19,40

Kühlakku / cooler / acumulador de frío / accumulateur de froid

	cm	↑ cm	pcs.	€
11101	16 x 7,5	2,0	4	4,70



Thermo-Set

thermo set
porta tartas refrigerado
porte-gâteau réfrigéré



4-teilig: 1 Tablett tief auf Fuß + 1 Tablett flach + 2 Kühlakkus

4 pcs. set: 1 deep tray with feet + 1 tray + 2 cooler

set de 4 piezas: 1 bandeja honda con pie + 1 bandeja + 2 acumuladores de frío

set de 4 pièces: 1 plateau creux avec pied + 1 plateau plat + 2 accum.

	Ø cm	↑ cm		€
09083	38	14,5		50,00

Rolltophaube / rolltop cover / campana abatible / cloche basculante

	Ø cm	↑ cm		€
18388	38	20	mit verchromtem Kugelgriff	19,40

Kühlakku / cooler / acumulador de frío / accumulateur de froid

	cm	↑ cm	pcs.	€
11101	16 x 7,5	2,0	4	4,70

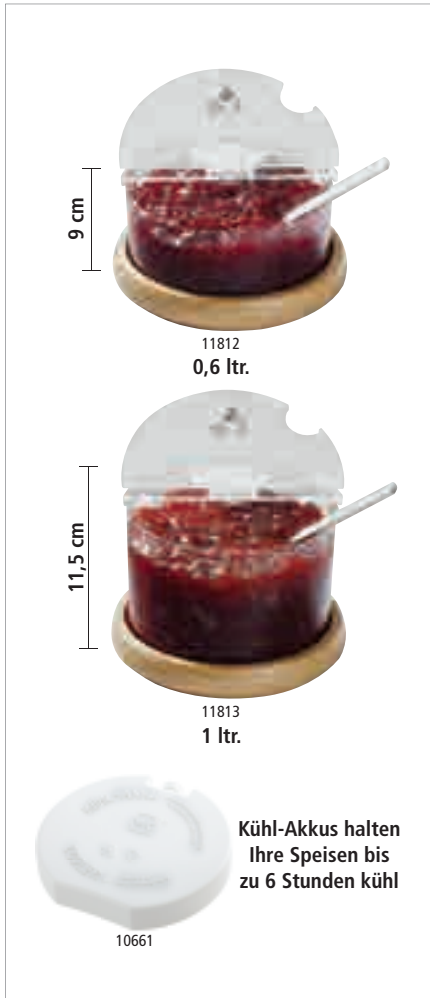

Kühlschale Mini Holz „TOP FRESH“

cool bowl mini holz
bol refrigerado mini madera
bol réfrigéré MINI bois

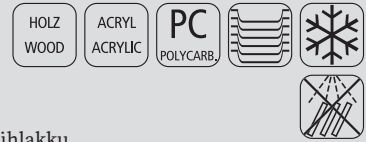

4-teilig: 1 Fuß Buchen-Holz versiegelt + 1 Schale + 1 Kühlakku + 1 klappbarer Deckel mit Beschriftungsschild

4 pcs. set: 1 column with food base (beech) + 1 bowl + 1 cooler + 1 cover with card, hinged

set de 4 piezas: 1 bol polycarbonato + 1 base madera + 1 acum. de frío + 1 tapa con bisagra y porta etiqueta

set de 4 pièces : 1 base en bois + 1 accum + 1 bol polycarbonate + 1 couvercle à charnière avec porte-étiquette

	Ø cm	↑ cm	ltr.	€
11812	14	9	0,6	39,00
11813	14	11,5	1	41,00

Ersatzschale / spare bowl / recambio bol / bol de rechange

	Ø cm	↑ cm	€
11811	14	6,5	15,40
11816	14	9	21,40

Schutzdeckel mit Löffelaussparung / cover / tapa / couvercle

	Ø cm	€
11868	14,5	10,40

Kühlakku / cooler / acumulador de frío / accumulateur de froid

	Ø cm	↑ cm	€
10661	10,5	2,0	3,20



Kühlschale Maxi Holz „TOP FRESH“

cool bowl maxi holz
bol refrigerado MAXI madera
bol réfrigéré MAXI bois

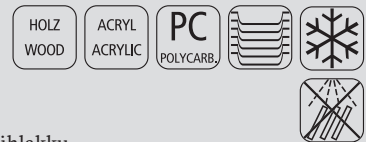

4-teilig: 1 Fuß Buchen-Holz versiegelt + 1 Schale + 1 Kühlakku + 1 klappbarer Deckel mit Beschriftungsschild

4 pcs. set: 1 column with food base (beech) + 1 bowl + 1 cooler + 1 cover with card, hinged

set de 4 piezas: 1 bol + 1 base madera + 1 acumulador de frío + 1 tapa con bisagra y porta etiqueta

set de 4 pièces : 1 base en bois + 1 accum. + 1 bol + 1 couvercle à charnière avec porte-étiquette

	Ø cm	↑ cm	ltr.	€
11817	22	14	2,5	94,00
11818	22	18	4	102,00

Ersatzschale / spare bowl / recambio bol / bol de rechange

	Ø cm	↑ cm	€
11846	22	8	35,00
11848	22	12	44,80

Schutzdeckel mit Löffelaussparung / cover / tapa / couvercle

	Ø cm	€
11878	23,5	11,40

Kühlakku / cooler / acumulador de frío / accumulateur de froid

	Ø cm	↑ cm	€
10777	15	2,5	5,00

Buffet & Display

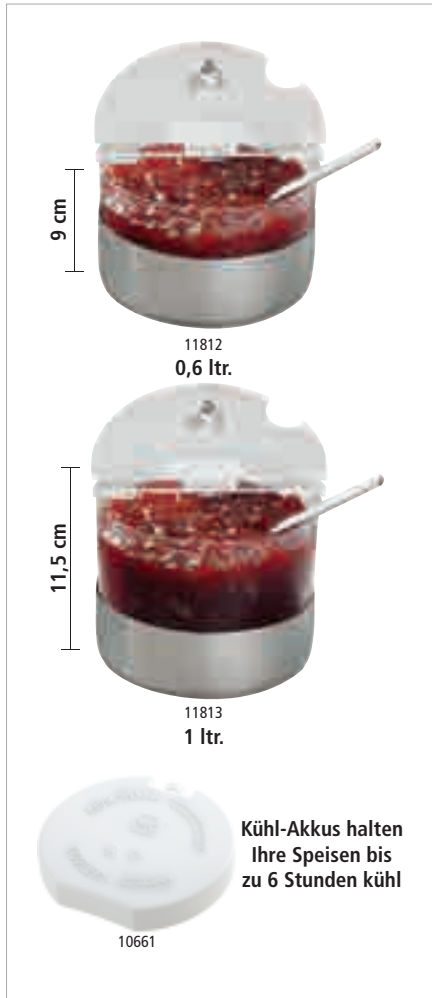

Kühlschale Mini „TOP FRESH“

cool bowl mini
bol refrigerado MINI
bol réfrigéré MINI



4-teilig: 1 Edelstahlgefäß matt + 1 Kühlakku + 1 Schale + 1 klappbarer Deckel mit Beschriftungsschild

4 pcs. set: 1 column satin polished finish + 1 cooler + 1 bowl + 1 cover with card, hinged
set de 4 piezas: 1 base acabado efecto satinado + 1 acumulador de frío + 1 tapa con porta etiqueta + 1 bol

set de 4 pièces: 1 base inox mat satiné + 1 accum. de froid + 1 couvercle à charnière avec porte étiquette + 1 bol

	Ø cm	↑ cm	ltr.	€
11810	14	9	0,6	42,00
11815	14	11,5	1	44,00

Ersatzschale / spare bowl / recambio bol / bol de rechange

	Ø cm	↑ cm	€
11811	14	6,5	15,40
11816	14	9	21,40

Schutzdeckel mit Löffelaussparung / cover / tapa / couvercle

	Ø cm	€
11868	14,5	10,40

Kühlakku / cooler / acumulador de frío / accumulateur de froid

	Ø cm	↑ cm	€
10661	10,5	2,0	3,20



Kühlschale Maxi „TOP FRESH“

cool bowl maxi
bol refrigerado MAXI
bol réfrigéré MAXI



4-teilig: 1 Gefäß hochglanzpoliert + 1 Kühlakku + 1 Schale + 1 klappbarer Deckel mit Beschriftungsschild

4 pcs. set: 1 column mirror polished finish + 1 cooler + 1 bowl + 1 cover with card, hinged
set de 4 piezas: 1 base pulido acabado efecto espejo + 1 acumulador de frío + 1 tapa con porta etiqueta + 1 bol

set de 4 pièces : 1 base inox poli brillant + 1 accum. + 1 récipient + 1 couvercle à charnière avec porte-étiquette

	Ø cm	↑ cm	ltr.	€
11847	22	14	2,5	98,00
11849	22	18	4	102,00

Ersatzschale / spare bowl / recambio bol / bol de rechange

	Ø cm	↑ cm	€
11846	22	8	35,00
11848	22	12	44,80

Schutzdeckel mit Löffelaussparung / cover / tapa / couvercle

	Ø cm	€
11878	23,5	11,40

Kühlakku / cooler / acumulador de frío / accumulateur de froid

	Ø cm	↑ cm	€
10777	15	2,5	5,00



11845
2,5 ltr.

11875

Kühlschale Maxi „TOP FRESH“

cool bowl maxi
cuenco refrigerado MAXI
bol réfrigéré MAXI



4-teilig: 1 Gefäß hochglanzpoliert + 1 Kühlakku + 1 Glasschale
+ 1 klappbarer Deckel mit Beschriftungsschild

4 pcs. set: 1 column mirror polished finish + 1 cooler
+ 1 glass bowl + 1 cover with card, hinged

set de 4 piezas: 1 base pulido acabado efecto espejo
+ 1 acumulador de frío + 1 tapa con porta etiqueta + 1 bol vidrio

set de 4 pièces : 1 base inox poli brillant + 1 accum.
+ 1 bol verre + 1 couvercle à charnière avec porte-étiquette

	Ø cm	↑ cm	ltr.	€
11845	23	14	2,5	76,00

Schale / bowl / cuenco / bol

	Ø cm	↑ cm	ltr.	€
11875	23	10,5	2,5	4,20

Schutzdeckel mit Löffelaussparung / cover / tapa / couvercle

	Ø cm	€
11878	23,5	11,40

Kühlakku / cooler / acumulador de frío / accumulateur de froid

	Ø cm	↑ cm	€
10777	15	2,5	5,00



83696

83705

83920

Schale „CASUAL MAXI“

bowl
cuenco
bol



	Ø cm	↑ cm	ltr.	Farbe / Colour	€
83696	10	4,5	0,15	White	2,60
83698	12	5,5	0,25	White	3,20
83700	14	6,5	0,50	White	3,80
83704	20	9,2	1,80	White	7,90
83702	23	10,5	2,50	White	9,00

	Ø cm	↑ cm	ltr.	Farbe / Colour	€
83697	10	4,5	0,15	Black	2,60
83699	12	5,5	0,25	Black	3,20
83701	14	6,5	0,50	Black	3,80
83705	20	9,2	1,80	Black	7,90
83703	23	10,5	2,50	Black	9,00

Deckel „FLOAT“ mit Löffelaussparung / cover, with notched for spoons / tapa, con espacio para la cuchara / couvercle, avec encoche pour la louche

	Ø cm	↑ cm	fits to	€
83920	20,5	1,3	83704, 83705	8,20

Buffet & Display



Glaskaraffe

glass carafe
jarra de vidrio
carafe en verre



Deckel aus Edelstahl matt poliert, mit integriertem Auffangsieb für Kerne oder Eis
lid made of matt polished stainless steel, with integrated strainer for cores or ice
tapa de acero inoxidable pulido mate, con filtro integrado para los huesos o el hielo
couverture en acier inox poli mat, avec filtre intégré pour les pépins ou la glace

	Ø cm	↑ cm	ltr.	€
10792	10	26	1,5	14,90



Deckel mit Doppelfunktion
spout for drip-free pouring



Glaskaraffe „LINES“

glass carafe
jarra de vidrio
carafe en verre



	Ø cm	↑ cm	ltr.	pattern	€
10738	8	27	0,9	Lines	12,00



Detailansicht
detail view „LINES“



Glaskaraffe „DOTS“

glass carafe
jarra de vidrio
carafe en verre



	Ø cm	↑ cm	ltr.	pattern	€
10739	8	27	0,9	Dots	12,00

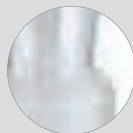

Detailansicht
detail view „DOTS“



Glaskaraffe

glass carafe
jarra de vidrio
carafe en verre



	Ø cm	↑ cm	ltr.	€
10745	11	25,5	1,6	4,90

NEW



0,8 ltr.



Detailansicht
detail view „WABE“

Glaskaraffe „WABE“

glass carafe
jarra de vidrio
carafe en verre



	Ø cm	↑ cm	ltr.	pattern	€
10741	8	28	0,8	Wabes	incl. wooden cork 16,00



HOLZ
WOOD

SILIKON
SILICON

inkl. Holzkorken mit Silikondichtung
incl. wooden cork with silicone gasket

NEW



0,8 ltr.



Detailansicht
detail view „DIAMOND“

Glaskaraffe „DIAMOND“

glass carafe
jarra de vidrio
carafe en verre



	Ø cm	↑ cm	ltr.	€
10742	8	28	0,8	16,00



HOLZ
WOOD

SILIKON
SILICON

inkl. Holzkorken mit Silikondichtung
incl. wooden cork with silicone gasket

NEW



0,8 ltr.



Detailansicht
detail view „RINGS“

Glaskaraffe „RINGS“

glass carafe
jarra de vidrio
carafe en verre



	Ø cm	↑ cm	ltr.	€
10743	8	28	0,8	16,00



HOLZ
WOOD

SILIKON
SILICON

inkl. Holzkorken mit Silikondichtung
incl. wooden cork with silicone gasket

NEW



1,0 ltr.



Flaschenverschluss
bottle top

Flasche „STRIPES“

bottle
botella
bouteille



	Ø cm	↑ cm	ltr.	€
10748	9	28,5	1,0	9,00

NEW



1,0 ltr.



Flaschenverschluss
bottle top

Flasche „STRIPES“

bottle
botella
bouteille



	Ø cm	↑ cm	ltr.	€
10749	9,0	28,5	1,0	9,00

Buffet & Display



Kühlkaraffe, 3-teilig „COOL“

cooling carafe, 3 pcs. set
jarra fría, set de 3 piezas
pichet rafraîchisseur, set 3 pièces



1 Glaskaraffe mit Edelstahl-Ausgießer, öffnet und schließt selbstständig + 1 verchromter Fuß + 1 Kühllakku, werden bis zu 4 Stunden gekühlt

1 glass carafe with stainless steel pourer, open / closing autonomous + 1 chrome plated base + 1 cooling pack, up to 4 hours cooled beverages

1 botella de vidrio con vertedor inox y silicona, con autocierre + 1 base cromada + 1 placa de frio que mantiene las bebidas frescas hasta unas 4 horas

pichet en verre avec insert verseur inox et silicone, fermeture automatique + socle chromé + accumulateur de froid pour maintenir les boissons froides jusqu'à 4 heures

	Ø cm	↑ cm	ltr.	€
10762	16	27	1,4	31,00

Glasflasche / glass carafe / jarra de vidrio / pichet verre

	Ø cm	↑ cm	€
10761	16	26	22,00

Kühllakku rund, schwarz / cooler round, black / cooler / accumulateur de froid, noir

	Ø cm	↑ cm	€
10752	10,5	2,0	4,60



Glaskaraffe

glass carafe
jarra
pichet en verre



der Deckel öffnet sich beim Ausgießen automatisch

cover opens automatically while pouring

la tapa se abre automáticamente durante el vertido

le couvercle s'ouvre seul pendant le service, résistant à la chaleur

	Ø cm	↑ cm	ltr.	€
10766	9,5	29	1	19,00



Glaskaraffe

glass carafe
jarra
pichet verre



Deckel aus Edelstahl matt poliert

stainless steel cover

tapa de acero inoxidable

couvercle inox

	Ø cm	↑ cm	ltr.	€
10764	9,5	27	1,5	22,50



spout for drip-free pouring



Kanne

pitcher
jarra
pichet



mit transparentem Deckel, ideal für Milch

included transparent cover, perfect for milk

tapa transparente, perfecto para leche

couvercle transparent, pour lait

	Ø cm	↑ cm	ltr.	€
84225	14	21	2	25,00



Saft- / Wasserkanne
juice / water pitcher
jarra de zumo / agua
pichet à eau ou jus de fruit



mit Eiswasser-Röhre
with water ice tube
con tubo para hielo
avec tube à glaçons plongeant pour réfrigérer

	cm	↑ cm	ltr.	€
10769	19 x 13	27	2,8	20,00



Saftkanne
juice pitcher
jarra de zumo
pichet à jus de fruit



mit Eiswasser-Röhre
with water ice tube
con tubo para hielo
avec tube à glaçons plongeant pour réfrigérer

	Ø cm	↑ cm	ltr.	€
10770	18,0	29	3	23,00



Saftkanne
juice pitcher
jarra de zumo
pichet à jus de fruit



mit Eiswasser-Röhre und Fruchtkammer, Inhalt mit Röhre 2,2 Liter
with water ice tube and fruit tube, capacity with tube 2,2 liters
con tubo para agua, capacidad con tubo 2,2 litros
avec tube à glaçons plongeant pour réfrigérer, capacité 2,2 litres avec le tube

	cm	↑ cm	ltr.	€
10768	23 x 13	27	2,5	32,00



Saftkanne
juice pitcher
jarra de zumo
pichet à jus de fruit



	Ø cm	↑ cm	ltr.	€
10775	12	26	2	18,50

Buffet & Display



Saftkanne
juice pitcher
jarra de zumo
pichet à jus de fruit



	Ø cm	↑ cm	ltr.	€
10776	14	29	2,5	15,40



Pitcher
pitcher
jarra
pichet



	Ø cm	↑ cm	ltr.	€
93105	13	21	1,5	8,40



Karaffe / Kanne
bottle
botella
bouteille



Schraubdeckel mit aromadichtem Verschluss
screwed lid, aroma-tight
tapón de rosca, impide la fuga de aromas
bouchon à visser, ne laisse pas passer les arômes

	Ø cm	↑ cm	ltr.	Farbe / Colour	€
10771	11	30	1,6		12,90
10772	11	30	1,6		12,90



Karaffe / Kanne
bottle
botella
bouteille



Schraubdeckel mit aromadichtem Verschluss
screwed lid, aroma-tight
tapón de rosca, impide la fuga de aromas
bouchon à visser, ne laisse pas passer les arômes

	Ø cm	↑ cm	ltr.	Farbe / Colour	€
10773	11	30	1,6		12,90
10774	11	30	1,6		12,90



Teekanne „ASIA“

teapot
tetera
théière



aus Gusseisen, innen emailliert, hält den Tee lange warm,
kein nachbittern, ideal für zwei Tassen

made of cast iron, keeps the tea warm for
a long time, no bitterness, ideal for two cups

hecho de hierro fundido, mantiene el té caliente durante
mucho tiempo, sin amargar, ideal para dos tazas

en fonte, maintient le thé chaud pendant longtemps,
pas d'amertume, idéal pour deux tasses

	cm	↑ cm	ltr.	€
10990	12,5 x 11	12,5	0,3	19,00



Teebrühsieb

snap mesh tea ball
infusor de té, pinza con malla
boule à thé avec pince



matt poliert, mit feinem Sieb, aufklappbar

satin polished finish, with fine mesh, hinged

acabado pulido efecto satinado, con malla fina, con bisagra

inox mat, maille fine, avec charnière

	Ø cm	→ cm	€
74750	4,5	15,5	2,10



Zitronenschnitzelpresse

lemon slice squeezer
pinza exprimelimon
pince presse citron



hochglanzpoliert, zum Auspressen von Zitronenscheiben

mirror polished finish, to press lemon slices

pulido brillante, para rodajas de limón

brillant, pour citrons en rondelle

	cm	€
71430	8 x 7	1,20



für ca. 30 Teebeutel
for approx. 30 teabags

Schale, 3-geteilt

bowl, 3-section
cuenco, 3 secciones
bol 3 compartiments



	cm	↑ cm	€
83536	17,5 x 7,5	4,5	5,00



GETRÄNKESPENDER



7 ltr.

Getränkespender „OLD FASHIONED“

drinks dispenser
dispensador de bebidas
distributeur de boissons



dicke, stabile Wände, weite Öffnung für große Zutaten, Gestell schwarz
thick, stable walls, a wide opening for large ingredients, black stand
tiene paredes gruesas y estables, amplia abertura para ingredientes grandes, soporte negro
des murs épais et stables, large ouverture pour de grands ingrédients, support noir

	Ø cm	↑ cm	ltr.		€
10409	27	50,5	7	inkl. Gestell / incl. stand	49,00

Ersatz-Gestell zu Getränkenspender / stand for drinks dispenser / soporte de recambio para el dispensador de bebidas / support de remplacement pour le distributeur de boissons

	Ø cm	↑ cm		€
10410	27	31,5		12,00

Ersatz-Glas zu Getränkenspender ohne Zapfhahn / replacement glass for drinks dispenser without tap / cristal de recambio para el dispensador de bebidas sin grifo / vitre de rechange pour le distributeur de boissons sans robinet

	Ø cm	↑ cm	ltr.	€
10411	19	36,5	7	39,00

Ersatz-Zapfhahn zu Getränkenspender / replacement tap for drinks dispenser

	€
10718	24,00



7 ltr.

Getränkespender „ASIA“

drinks dispenser
dispensador de bebidas
distributeur de boissons



dicke, stabile Wände, weite Öffnung für große Zutaten, Fuß und Deckel aus Holz
thick, stable walls, a wide opening for large ingredients, wooden stand and lid
tiene paredes gruesas y estables, amplia abertura para ingredientes grandes, soporte y tapa de madera
des murs épais et stables, large ouverture pour de grands ingrédients, support et couvercle en bois

	Ø cm	↑ cm	ltr.		€
10403	24,5	45,5	7	inkl. Gestell / incl. stand	69,00

Ersatz-Fuß zu Getränkenspender mit Anti-Rutsch-Füßchen / base to drinks dispenser with non slip feet / soporte de recambio para el dispensador de bebidas con pies antideslizantes / support de remplacement pour le distributeur de boissons avec pieds antidérapants

	Ø cm	↑ cm		€
10404	24,5	15,0		22,00

Ersatz-Deckel zu Getränkenspender / replacement lid for drinks dispenser / tapa de recambio para el dispensador de bebidas / couvercle de rechange pour le distributeur de boissons

	Ø cm	↑ cm		€
10405	14,0	5,0		8,00



6 ltr.



Getränkespender „GINGER“

drinks dispenser
dispensador de bebidas
distributeur de boissons



weite Öffnung für große Zutaten, 1 Kühlakku im Standfuß

wide opening for large ingredients, 1 cooler in the base

amplia abertura para ingredientes grandes, 1 acumulador de frío en la base

large ouverture pour de grands ingrédients, 1 accumulateur de froid dans le socle

	Ø cm	↑ cm	ltr.		€
10406	20	49,5	6	inkl. Gestell / incl. stand	194,00

Ersatz-Fuß zu Getränkenspender mit Anti-Rutsch-Füßchen

base to drinks dispenser with non slip feet

soporte de recambio para el dispensador de bebidas con pies antideslizantes

support de remplacement pour le distributeur de boissons avec pieds antidérapants

	Ø cm	↑ cm	€
10407	18	13,5	22,00

Ersatz-Deckel zu Getränkenspender / replacement lid for drinks dispenser / tapa de recambio para el dispensador de bebidas / couvercle de rechange pour le distributeur de boissons

	Ø cm	↑ cm	€
10408	20	7,5	14,00

Kühlakku / cooler / acumulador de frío / accumulateur de froid

	Ø cm	↑ cm	€
10777	15	2,5	5,00

Behälter inkl. Zapfhahn / container incl. tap / recipiente con grifo / récipient avec robinet

	ltr.	€
10703	6	157,00



7 ltr.

Getränkespender „ELEMENT“

drinks dispenser
dispensador de bebidas
distributeur de boissons



dicke, stabile Wände, weite Öffnung für große Zutaten, Fuß und Deckel aus Beton

thick, stable walls, a wide opening for large ingredients, stand and lid made of concrete

tiene paredes gruesas y estables, amplia abertura para ingredientes grandes, soporte y tapa de hormigón

des murs épais et stables, large ouverture pour de grands ingrédients, support et couvercle en béton

	Ø cm	↑ cm	ltr.		€
10400	22	45	7	inkl. Gestell / incl. stand	84,00

Ersatz-Fuß zu Getränkenspender mit Anti-Rutsch-Füßchen / base to drinks dispenser with non slip feet / soporte de recambio para el dispensador de bebidas con pies antideslizantes / support de remplacement pour le distributeur de boissons avec pieds antidérapants

soporte de recambio para el dispensador de bebidas con pies antideslizantes / support de remplacement pour le distributeur de boissons avec pieds antidérapants

	Ø cm	↑ cm	€
10401	22	17	36,00

Ersatz-Deckel zu Getränkenspender / replacement lid for drinks dispenser / tapa de recambio para el dispensador de bebidas / couvercle de rechange pour le distributeur de boissons

	Ø cm	↑ cm	€
10402	14	2,5	8,00



10,5 ltr.

300 ml

Dichtung aus Polyethylen
seal made of polyethylene

300 ml

Getränkespender „FRUITS“

drinks dispenser
dispensador de bebidas
distributeur de boissons



dicke, stabile Wände, weite Öffnung für große Zutaten, Gestell schwarz
thick, stable walls, a wide opening for large ingredients, black stand
tiene paredes gruesas y estables, amplia abertura para ingredientes grandes, soporte negro
des murs épais et stables, large ouverture pour de grands ingrédients, support noir

	Ø cm	↑ cm	ltr.		€
10415	25	58	10,5	inkl. Gestell / incl. stand	69,00

Trinkglas „BEACH“

drinking glass / vaso / verre



	Ø cm	↑ cm	ltr.	VE	€ / pc.
10505	8,5	13,5	0,3	48	3,40

Ersatzteile Getränkspender „FRUITS“

spare parts drinks dispenser
recambios dispensador de bebidas
pièces distributeur de boissons

Ersatz-Deckel zu Getränkspender „FRUITS“

replacement glass for drinks dispenser / cristal de recambio
para el dispensador de bebidas / vitre de rechange pour le
distributeur de boissons



	Ø cm	↑ cm		€
10418	14	12		9,00

Ersatz-Glas zu Getränkspender „FRUITS“ inkl. Deckel, ohne Zapfhahn

replacement glass for drinks dispenser without tap
cristal de recambio para el dispensador de bebidas sin grifo
vitre de rechange pour le distributeur de boissons sans robinet

	Ø cm	↑ cm	ltr.	€
10417	25	42	10,5	24,00

Ersatz-Zapfhahn zu Getränkspender

replacement tap for drinks dispenser
grifo de recambio para el dispensador de bebidas
robinet de rechange pour le distributeur de boissons



		€
10718		24,00

Ersatz-Gestell zu Getränkspender

stand for drinks dispenser
soporte de recambio para el dispensador de bebidas
support de remplacement pour le distributeur de boissons



	Ø cm	↑ cm		€
10416	26	19		22,00

Trinkglas „OLD FASHIONED“

drinking cup
vaso
gobelet



	Ø cm	↑ cm	ltr.	VE	€
10520	7,0	12,5	0,3	6	1,20



4,5 ltr.

Getränkespender „FRESH WHITE“

drinks dispenser
dispensador de bebidas
distributeur de boissons

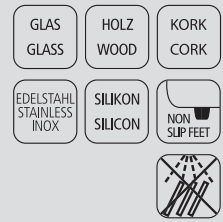

Behälter mit Edelstahlzapfhahn und Holzdeckel, stabiles Glas,
inkl. weißem Holzstandfuß und Kork-Untersetter

container with stainless steel tap and wooden cover, solid glass,
incl. white wooden base and cork coaster

recipiente con grifo de acero inoxidable y tapa de madera, cristal sólido,
incl. pie de madera blanca y posavasos de corcho

réceptier avec robinet en acier inox et couvercle en bois, verre robuste,
incl. pied en bois blanc et soucoupes de liège

	cm	↑ cm	ltr.		€
10420	23 x 23	56,5	4,5	inkl. Gestell / incl. stand	69,00

Trinkbecher „CRYSTAL“ drinking cup / vaso / gobelet



	Ø cm	↑ cm	ltr.	VE	€ / pc.
10501	8	12,5	0,3	48	2,80



Glas inkl.
Zapfhahn

Ersatzteile Getränkspender „FRESH WHITE“

spare parts drinks dispenser
recambios dispensador de bebidas
pièces distributeur de boissons

Ersatz-Deckel zu Getränkspender „FRESH WHITE“

replacement lid for drinks dispenser
tapa de recambio para el dispensador de bebidas
couvercle de rechange pour le distributeur de boissons



	Ø cm	↑ cm	Farbe / Colour	€
10423	11,5	1,5	weiß	4,00

Ersatz-Glas zu Getränkspender „FRESH WHITE“, inkl. Zapfhahn

replacement glass for drinks dispenser with tap
cristal de recambio para el dispensador de bebidas con grifo
vitre de rechange pour le distributeur de boissons avec robinet



	Ø cm	↑ cm	ltr.	€
10422	15,5	42,0	4,5	44,00

Ersatz-Untersetter aus Kork zu Getränkspender „FRESH WHITE“

replacement cork coaster for drinks dispenser
posavasos de corcho de recambio para el dispensador de bebidas
soucoupes de liège de rechange pour le distributeur de boissons



	Ø cm	↑ cm	€
10424	16,5	1,5	4,00

Ersatz-Gestell zu Getränkspender „FRESH WHITE“

stand for drinks dispenser
soporte de recambio para el dispensador de bebidas
support de remplacement pour le distributeur de boissons



	cm	↑ cm	Farbe / Colour	€
10421	23 x 23	14	weiß	20,00



4,5 ltr.

4,5 ltr.

Glas inkl. Zapfhahn

Getränkespender „FRESH WOOD“

drinks dispenser
dispensador de bebidas
distributeur de boissons

Behälter mit Edelstahlzapfhahn und Korkdeckel, stabiles Glas, inkl. Holzstandfuß und Kork-Untersetzer

container with stainless steel tap and cork cover, solid glass, incl. wooden base and cork coaster

recipiente con grifo de acero inoxidable y tapa de corcho, cristal sólido, incl. pie de madera y posavasos de corcho

réipient avec robinet en acier inox et couvercle de liège, verre robuste, incl. pied en bois et soucoupes de liège

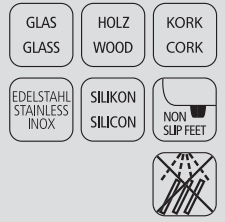

	cm	↑ cm	ltr.		€
10430	23 x 23	56,5	4,5	inkl. Gestell / incl. stand	69,00

Trinkbecher „CRYSTAL“
drinking cup / vaso / gobelet



	Ø cm	↑ cm	ltr.	VE	€ / pc.
10501	8	12,5	0,3	48	2,80

Tropfenschale
drip tray
aro anti-goteo
anneau coupe-gouttes



	Ø cm	↑ cm	Farbe / Colour	€ / pc.
10851	9,5	1,5	White	6,50

Ersatzteile Getränkspender „FRESH WOOD“

spare parts drinks dispenser
recambios dispensador de bebidas
pièces distributeur de boissons

Ersatz-Deckel zu Getränkspender „FRESH WOOD“
replacement lid for drinks dispenser
tapa de recambio para el dispensador de bebidas
couvercle de rechange pour le distributeur de boissons



	Ø cm	↑ cm	Farbe / Colour	€
10428	11,5	1,5	Orange	4,00

Ersatz-Glas zu Getränkspender „FRESH WOOD“, inkl. Zapfhahn
replacement glass for drinks dispenser with tap
cristal de recambio para el dispensador de bebidas con grifo
vitre de rechange pour le distributeur de boissons avec robinet



	Ø cm	↑ cm	ltr.	€
10422	15,5	42,0	4,5	44,00

Ersatz-Untersetzer aus Kork zu Getränkspender „FRESH WOOD“
replacement cork coaster for drinks dispenser
posavasos de corcho de recambio para el dispensador de bebidas
soucoupes de liège de rechange pour le distributeur de boissons



	Ø cm	↑ cm	€
10424	16,5	1,5	4,00

Ersatz-Gestell zu Getränkspender „FRESH WOOD“
stand for drinks dispenser
soporte de recambio para el dispensador de bebidas
support de remplacement pour le distributeur de boissons



	cm	↑ cm	Farbe / Colour	€
10426	23 x 23	14	Orange	20,00



7,5 ltr.

Getränkespender „NORDIC WHITE“

drinks dispenser
dispensador de bebidas
distributeur de boissons

Behälter mit Edelstahlzapfhahn und Holzdeckel, stabiles Glas,
inkl. weißem Holzstandfuß und Kork-Untersetzer

container with stainless steel tap and wooden cover, solid glass,
incl. white wooden base and cork coaster

recipiente con grifo de acero inoxidable y tapa de madera, cristal sólido,
incl. pie de madera blanca y posavasos de corcho

réceptif avec robinet en acier inox et couvercle en bois, verre robuste,
incl. pied en bois blanc et soucoupes de liège

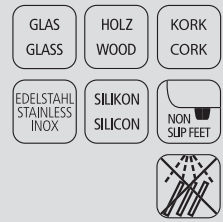

	cm	↑ cm	ltr.		€
10425	23 x 23	60,5	7,5	inkl. Gestell / incl. stand	69,00



Trinkbecher „CRYSTAL

drinking cup / vaso / gobelet



	Ø cm	↑ cm	ltr.	VE	€ / pc.
10501	8	12,5	0,3	48	2,80



7,5 ltr.

Ersatzteile Getränkespender „NORDIC WHITE“

spare parts drinks dispenser
recambios dispensador de bebidas
pièces distributeur de boissons

Ersatz-Deckel zu Getränkespender „NORDIC WHITE“

replacement lid for drinks dispenser
tapa de recambio para el dispensador de bebidas
couvercle de rechange pour le distributeur de boissons avec robinet



	Ø cm	↑ cm	Farbe / Colour	€
10423	11,5	1,5		4,00

Ersatz-Glas zu Getränkespender „NORDIC WHITE“, inkl. Zapfhahn

replacement glass for drinks dispenser with tap
cristal de recambio para el dispensador de bebidas con grifo
vitre de rechange pour le distributeur de boissons avec robinet



	Ø cm	↑ cm	ltr.	€
10427	17	46	7,5	44,00



Ersatz-Untersetzer aus Kork zu Getränkespender „NORDIC WHITE“

replacement cork coaster for drinks dispenser
posavasos de corcho de recambio para el dispensador de bebidas
soucoupes de liège de rechange pour le distributeur de boissons



	Ø cm	↑ cm	€
10424	16,5	1,5	4,00



Ersatz-Gestell zu Getränkespender „NORDIC WHITE“

stand for drinks dispenser
soporte de recambio para el dispensador de bebidas
support de remplacement pour le distributeur de boissons



	cm	↑ cm	Farbe / Colour	€
10421	23 x 23	14		20,00



7,5 ltr.

7,5 ltr.

Glas inkl. Zapfhahn

Getränkespender „NORDIC WOOD“

drinks dispenser
dispensador de bebidas
distributeur de boissons

Behälter mit Edelstahlzapfhahn und Korkdeckel, stabiles Glas, inkl. Holzstandfuß und Kork-Untersetzer

container with stainless steel tap and cork cover, solid glas, incl. wooden base and cork coaster

recipiente con grifo de acero inoxidable y tapa de corcho, cristal sólido, incl. pie de madera y posavasos de corcho

réipient avec robinet en acier inox et couvercle de liège, verre robuste, incl. pied en bois et soucoupes de liège

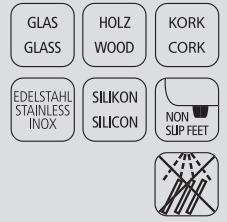

	cm	↑ cm	ltr.		€
10435	23 x 23	60,5	7,5	inkl. Gestell / incl. stand	69,00

Trinkbecher „CRYSTAL“
drinking cup / vaso / gobelet



	Ø cm	↑ cm	ltr.	VE	€ / pc.
10501	8	12,5	0,3	48	2,80

Ersatzteile Getränkspender „NORDIC WOOD“

parts drinks dispenser
recambios dispensador de bebidas
pièces distributeur de boissons

Ersatz-Deckel zu Getränkspender
replacement lid for drinks dispenser
tapa de recambio para el dispensador de bebidas
couvercle de rechange pour le distributeur de boissons



	Ø cm	↑ cm		€
10428	11,5	1,5		4,00

Ersatz-Glas zu Getränkspender „NORDIC WOOD“, inkl. Zapfhahn
replacement glass for drinks dispenser with tap
cristal de recambio para el dispensador de bebidas con grifo
vitre de rechange pour le distributeur de boissons avec robinet



	Ø cm	↑ cm	ltr.	€
10427	17,0	46,0	7,5	44,00

Ersatz-Untersetzer aus Kork zu Getränkspender „NORDIC WOOD“
replacement cork coaster for drinks dispenser
posavasos de corcho de recambio para el dispensador de bebidas
soucoupes de liège de rechange pour le distributeur de boissons



	Ø cm	↑ cm		€
10424	16,5	1,5		4,00

Ersatz-Gestell zu Getränkspender „NORDIC WOOD“
stand for drinks dispenser
soporte de recambio para el dispensador de bebidas
support de remplacement pour le distributeur de boissons



	cm	↑ cm	Farbe / Colour	€
10426	23 x 23	14		20,00



Getränkespender
Drinks Dispenser
dispensador de bebidas
distributeur de boissons



dicke, stabile Wände, weite Öffnung für große Zutaten
thick, stable walls, a wide opening for large ingredients
tiene paredes gruesas y estables, amplia abertura para ingredientes grandes
des murs épais et stables, large ouverture pour de grands ingrédients

	Ø cm	↑ cm	ltr.	€
10855	20	30,5	7	49,00



Tropfenschale (2-tlg.)
drip tray
aros anti-goteo
anneaux coupe-gouttes



	Ø cm	↑ cm	Farbe / Colour	€
10851	9,5	1,5	White	6,00
10853	9,5	1,5	Black	6,00



Trinkbecher „CRYSTAL“
drinking cups
vasos
gobelets

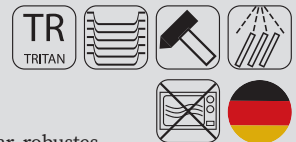

Kristallglas-Optik, vielseitig einsetzbar, robustes, unzerbrechliches Material, ideal in sensiblen Bereichen wie Pool, Spa, Beach und Wellness einzusetzen, BPA-frei
crystal-glass-look, can be used in versatile ways, a solide and unbreakable material, ideal to be used in pool, spa, beach and wellness areas, bpa-free

look de vidrio, se pueden utilizar de muchas maneras diferentes, material sólido e irrompible, ideal para el uso en áreas como piscina, spa, playa y bienestar, libre de BPA

look de verre de cristal, peuvent être utilisés de différentes façons, matériau robuste et incassable, idéal pour une utilisation dans des zones comme la piscine, le spa, la plage et le bien-être, sans BPA

	Ø cm	↑ cm	ltr.	VE	€/ pc.
10500	7	9,5	0,15	48	2,00
10501	8	12,5	0,30	48	2,80
10502	9	15,5	0,50	48	3,20



12 ltr.

Kaffeedispenser „ROYAL“

coffee dispenser
dispensador de café
distributeur de café



hochglanzpoliert, für warme Getränke, stabil und standfest, inkl. 1 Brennpastenbehälter
mirror polished finish, for warm drinks, solid and stable, incl. 1 burner holder
acabado brillante para bebidas calientes, sólido y estable, incluye un calentador
brillant, pour boissons chaudes, avec 1 brûleur, robuste et stable

	cm	↑ cm	ltr.	€
11667	28 x 28	65	12	256,00



10,5 ltr.

Kaffeedispenser „HAPPY HOUR“

coffee dispenser
dispensador de café
distributeur de café



hochglanzpoliert, für warme Getränke, stabil und standfest, inkl. 1 Brennpastenbehälter
mirror polished finish, for warm drinks, solid and stable, incl. 1 burner holder
acabado pulido brillante para bebidas calientes, sólido y estable, incluye un calentador
brillant, pour boissons chaudes, avec 1 brûleur, robuste et stable

	cm	↑ cm	ltr.	€
11672	31 x 33,5	54,5	10,5	190,00

Hahn / tap / grifo / robinet

11671	€	25,00
-------	---	-------

Elektro-Heizelement / heating unit / resistencia / résistance

	cm	↑ cm	€
12287	21 x 20	6	98,00



Saftdispenser „TOP FRESH“

juice dispenser
dispensador de zumo
distributeur à jus de fruit



hochglanzpoliert, Kühlung durch 2 Kühlakkus von oben und unten
mirror polished finish, cooling with 2 cooling elements from the top and base

base inox brillante, con 2 acum. de frio, 1 arriba y 1 en la base
base inox poli brillante, 2 plaques de froid (1 dans le couvercle, 1 dans le socle)

	cm	↑ cm	litr.	€
10800	21 x 32	43	4	229,00
10700	23 x 35	52	6	324,00



Saftdispenser DUO „TOP FRESH“

juice dispenser
dispensador de zumo
distributeur à jus de fruit



hochglanzpoliert, Kühlung durch 2 Kühlakkus von oben und unten

mirror polished finish, cooling with 2 cooling elements from the top and base

base inox brillante, con 2 acum. de frio, 1 arriba y 1 en la base
base inox poli brillante, 2 plaques de froid (1 dans le couvercle, 1 dans le socle)

	cm	↑ cm	litr.	€
10720	42 x 32	52	2 x 6	479,00



Saft- und Milchdispenser MIX „TOP FRESH“

juice and milk dispenser
dispensador mixto zumo y leche
distributeur mixte à lait et à jus de fruit



6 Liter Saftbehälter, 5 Liter Milchkanne, Kühlung durch Kühlakkus von oben und unten

6 liters juice container, 5 liters milkcan, cooling with cooling elements from the top and base

recipiente de zumo 6 litros, recipiente de leche 5 litros, 2 enfriadores
récipient à jus 6 l, récipient à lait 5 l, plaques de froid

	cm	↑ cm	litr.	€
10760	42 x 35	52	6 + 5	710,00



Saftdispenser WOOD „TOP FRESH“

juice dispenser
dispensador de zumo
distributeur à jus de fruit



Buchen-Holz versiegelt, Kühlung durch 2 Kühlakkus von oben und unten (nur 10730)

beech wood, waterproof, cooling with 2 cooling elements from the top and base (only 10730)

madera de haya con tratamiento anti humedad, 2 acumuladores de frío, 1 en la base y 1 en la tapa (solamente 10730)

bois de hêtre traité anti-humidité, 2 plaques de froid, 1 dans le couvercle, 1 dans le socle (seulement 10730)

	cm	↑ cm	litr.	€
10820	21 x 31	44	4	250,00
10730	23 x 35	52	6	370,00



1) Deckel / cover / tapa / couvercle		
	für ltr. / for ltr. / para ltr. / pour ltr.	€
10701	6	25,00
10801	4	21,00

2) Kühlakku / cooler / acumulador de frío / accumulateur de froid		
	für ltr. / for ltr. / para ltr. / pour ltr.	€
10777	4 / 6	5,00

3) Behälter inkl. Zapfhahn / container incl. tap / recipiente con grifo / récipient avec robinet		
	für ltr. / for ltr. / para ltr. / pour ltr.	€
10703	6	157,00
10803	4	134,00

3) Behälter ohne Zapfhahn / container without tap / recipiente sin grifo / récipient sans robinet		
	für ltr. / for ltr. / para ltr. / pour ltr.	€
10704	6	118,00
10804	4	97,00

4) Non-Drip Hahn / non-drip tap / grifo anti-goteo / robinet anti-goutte		
	für ltr. / for ltr. / para ltr. / pour ltr.	€
10707	6	45,00
10807	4	43,00

5) Dichtungsring / sealing ring / arandela / rondelle		
	für ltr. / for ltr. / para ltr. / pour ltr.	€
10608	4 / 6	1,60

6) Einsatz / insert / aro inox / cercle inox		
	für ltr. / for ltr. / para ltr. / pour ltr.	€
10708	6	4,40
10808	4	4,40

7) Standfuß 18/10 Edelstahl / column 18/10 stainless steel / base inox 18/10 / socle inox 18/10		
	für ltr. / for ltr. / para ltr. / pour ltr.	€
10709	6	70,00
10809	4	52,50

8) Tropfgitter 18/10 Edelstahl / drip lattice 18/10 stainless steel / rejilla recoge gotas 18/10 / grille ramasse-gouttes 18/10		
	für ltr. / for ltr. / para ltr. / pour ltr.	€
10712	6	24,00
10713	DUO	39,00
10812	4	21,00

9) Bodenplatte 18/10 Edelstahl / footing 18/10 stainless steel / base de 18/10 acero / socle inox 18/10		
	für ltr. / for ltr. / para ltr. / pour ltr.	€
10710	6	47,00
10711	DUO / 6 + 6	94,00
10814	4	33,00

Zubehör / Reinigungsset - für die regelmäßige Reinigung

1x Dichtung, 2x Dichtungsring (transparent), 1x Dichtungsring (s / w) 1x seal, 2x sealing ring (transparent), 1x sealing ring (b / w)		
		€
10714	für Zapfhahn 10707	3,20
10715	für Zapfhahn 10807	3,20
10716	für Zapfhahn 10907	4,20
10717	für Zapfhahn 10867	4,10



Saftdispenser WOOD DUO „TOP FRESH“

juice dispenser
dispensador de zumo
distributeur à jus de fruit

HOLZ
WOOD

EDELSTAHL
STAINLESS
INOX
18/8



SAN
KUNSTSTOFF

Buchen-Holz versiegelt, Kühlung durch 2 Kühllakkus von oben und unten

beech wood, waterproof, cooling with 2 cooling elements from the top and base

madera de haya con tratamiento anti humedad, 2 acumuladores de frio (1 en la base y 1 en la tapa)

bois de hêtre traité anti-humidité, 2 plaques de froid (1 dans le couvercle, 1 dans le socle)

	cm	↑ cm	ltr.	€
10740	42 x 35	52	2 x 6	579,00



Saft- und Milchdispenser WOOD DUO „TOP FRESH“

juice and milk dispenser
dispensador de zumo
distributeur à jus de fruit

HOLZ
WOOD

EDELSTAHL
STAINLESS
INOX
18/8



SAN
KUNSTSTOFF

6 Liter Saftbehälter, 5 Liter Milchkanne, Kühlung durch Kühllakkus von oben und unten, Buchen-Holz versiegelt

6 liters juice container, 5 liters milkcan, cooling with cooling elements from the top and base, beech wood, waterproof

madera de haya con tratamiento anti humedad, acumuladores de frio, enfriador en la base

bois de hêtre traité anti-humidité, plaques dans le socle

	cm	↑ cm	ltr.	€
10765	42 x 35	52	6 + 5	798,00



Iso-Dispenser

insulated dispenser
dispensador isotérmico
distributeur de boisson isothermique

ABS
KUNSTSTOFF

EDELSTAHL
STAINLESS
INOX
18/8

für heiße und kalte Getränke

for hot and cold drinks

para bebidas frías y calientes

pour boissons chaudes ou froides

	Ø cm	↑ cm	ltr.	€
10788	24	42	9,5	55,00

Hahn / tap / grifo / robinet

10789				10,30
-------	--	--	--	-------



Getränkespender

Drinks Dispenser
dispensador de bebidas
distributeur de boissons

GLAS
GLASS

EDELSTAHL
STAINLESS
INOX



dicke, stabile Wände, weite Öffnung für große Zutaten

thick, stable walls, a wide opening for large ingredients

tiene paredes gruesas y estables, amplia abertura para ingredientes grandes

des murs épais et stables, large ouverture pour de grands ingrédients

	Ø cm	↑ cm	ltr.	€
10855	20	30,5	7	49,00

Buffet & Display



Saftdispenser „SUNDAY“

juice dispenser
dispensador de zumo
distributeur à jus de fruit



matt poliert, Kühlung durch 2 Kühlakkus von oben und unten

satin polished finish, cooling with 2 cooling elements from the top and base

acabado pulido brillante, 2 acum. de frío (1 en la base y 1 en la tapa)

inox mat, 2 accus. de froid (1 socle et 1 couvercle)

	cm	↑ cm	ltr.	€
10860	21 x 35	48	6	264,00



Saft- / Milchdispenser „SUNDAY“

juice and milk dispenser
dispensador mixto zumo y leche
distributeur mixte à lait et à jus de fruit



matt poliert, Behälter gefrostet, Kühlung durch 2 Kühlakkus von oben und unten

satin polished finish, canister frosted look, cooling with 2 cooling elements from the top and base

inox acabado pulido mate, 1 recipiente policarbonato aspecto glaseado, 2 enfriadores en la base y en la tapa

inox mat, récipient polycarbonate opaque, 2 accus. de froid dans le socle et dans le couvercle

	cm	↑ cm	ltr.	€
10865	21 x 35	48	6	264,00



Saftdispenser DUO „SUNDAY“

juice dispenser
dispensador de zumo doble
distributeur à jus de fruit double



matt poliert, Kühlung durch 4 Kühlakkus von oben und unten

satin polished finish, cooling with 4 cooling elements from the top and base

inox acabado pulido mate, 4 enfriadores en la base y en la tapa

inox mat, 4 accus. de froid (socle et couvercle)

	cm	↑ cm	ltr.	€
10862	35 x 45	48	2 x 6	399,00



Saft- / Milchdispenser DUO „SUNDAY“

juice and milk dispenser
dispensador mixto zumo y leche
distributeur mixte à lait et à jus de fruit



matt poliert, 1 Behälter gefrostet, 1 Behälter transparent, 4 Kühlakkus von oben und unten

satin polished finish, 1 canister frosted look, 1 canister transparent, cooling with 4 cooling elements from the top and base

inox mate, 1 recipiente opaco, 1 recipiente transparente, 4 enfriadores (base y tapa)

inox mat, 1 récipient opaque, 1 récipient transparent, 4 accus. de froid (socle et couvercle)

	cm	↑ cm	ltr.	€
10864	35 x 45	48	2 x 6	399,00

Saftbehälter transparent, ohne Zapfhahn / juice canister transparent, without tap / contenedor transparente sin grifo / récipient cylindrique sans le robinet

	Ø cm	↑ cm	ltr.	€
10806	22	26	6	106,00

Milchbehälter, gefrostet, ohne Zapfhahn / milk canister, frosted look, without tap / contenedor de leche, efecto glaseado, sin grifo / récipient cylindrique mat (idéal pour le lait) sans le robinet

	Ø cm	↑ cm	ltr.	€
10805	22	26	6	111,00

Hahn / tap / grifo / robinet

				€
10867				41,50



Milchkanne „TOP FRESH“

milk dispenser
dispensador de leche
distributeur à lait



hochglanzpoliert, 1 Kühlakku im Standfuß, „original Milchkanne mit Henkel“
mirror polished finish, 1 cooler in base, original milkcan
inox brillante, 1 acumulador de frío en la base, recipiente „lechera“
inox poli brillant, 1 accum. de froid dans le socle, design „pot à lait“

	cm	↑ cm	ltr.	€
10830	21 x 32	39	3	279,00
10750	23 x 35	45	5	444,00

Milchkanne ohne Zapfhahn / milkcan without tapjarra de leche sin grifo / récipient à lait sans robinet

	Ø cm	↑ cm	ltr.	€
10833	16	22	3	162,00
10663	22	26	5	199,00



4 ltr. / 6 ltr.

Saftdispenser „BRIDGE“

juice dispenser
dispensador de zumo
distributeur à jus



Kühlung durch 2 Kühlakkus von oben und unten
cooling with 2 cooling elements from the top and base
2 acum. de frío 1 en la base y 1 en la tapa
2 plaques de froid 1 dans le couvercle, 1 dans le socle

	cm	↑ cm	ltr.	Farbe / Colour	€
10870	31,0 x 20,0	42	4		224,00
10871	35,5 x 22,0	50	6		264,00



inkl. 3 Magnetschilder: ORANGE, APPLE, GRAPEFRUIT
including 3 magnetic signs: ORANGE, APPLE, GRAPEFRUIT



4 ltr. / 6 ltr.

Saftdispenser „BRIDGE“

juice dispenser
dispensador de zumo
distributeur à jus



Kühlung durch 2 Kühlakkus von oben und unten
cooling with 2 cooling elements from the top and base
2 acum. de frío 1 en la base y 1 en la tapa
2 plaques de froid 1 dans le couvercle, 1 dans le socle

	cm	↑ cm	ltr.	Farbe / Colour	€
10872	31,0 x 20,0	42	4		224,00
10873	35,5 x 22,0	50	6		264,00



inkl. 3 Magnetschilder: ORANGE, APPLE, GRAPEFRUIT
including 3 magnetic signs: ORANGE, APPLE, GRAPEFRUIT

Buffet & Display



Milchkanne „TOP FRESH“

milk dispenser
dispensador de leche
distributeur à lait



inkl. Porzellanschild zum Beschriften, 1 Kühllakku im Fuß
incl. porcelain sign, 1 cooler in base
incluye cartelito en porcelana, 1 enfriador en la base
indicateur en porcelaine inclus, plaque de froid dans le socle

	cm	↑ cm	ltr.	€
10850	31 x 21	42	4	264,00



Milchkanne „TOP FRESH“

milk dispenser
dispensador de leche
distributeur à lait



Buchen-Holz versiegelt, inkl. Porzellanschild zum Beschriften, 1 Kühllakku im Fuß
beech wood, waterproof, incl. porcelain sign, 1 cooler in base
madera de haya, resistente al agua, incluye placa de porcelana, 1 enfriador en la base
socle bois hêtre traité, indicateur en porcelaine inclus, plaque de froid dans le socle

	cm	↑ cm	ltr.	€
10840	23 x 32	42	4	264,00
10757	27 x 38,5	45	8	310,00

Milchkanne Porzellan, ohne Zapfhahn / milkcan porcelain, without tap / jarra de leche sin grifo / récipient en porcelaine sans robinet

	Ø cm	↑ cm	ltr.	€
10825	18	25	4	85,00
10758	22	26	8	100,00

Deckel für 10840, 10850 / cover for 10840, 10850 / tapa para 10840, 10850 / couvercle pour 10840, 10850

	€
10859	7,00

Deckel für 10757 / cover for 10757 / tapa para 10757 / couvercle pour 10757

	€
10759	14,30

Schild und Kette / shield and chain / placa y cadena / indicateur porcelaine avec chaînette

	€
10756	5,00

Zapfhahn / tap / grifo / robinet

	€
10907	29,00



Milchkanne WOOD „TOP FRESH“

milk dispenser
dispensador de leche
distributeur à lait



Buchen-Holz versiegelt, 1 Kühllakku im Standfuß, „original Milchkanne mit Henkel“
beech wood, 1 cooler in base, original milkcan
madera de haya, 1 acumulador de frio en base
bois de hêtre, 1 plaque de froid dans le socle

	cm	↑ cm	ltr.	€
10835	21 x 32	39	3	305,00
10755	23 x 35	47	5	499,00



Saftdispenser „INOX STAR“

juice dispenser
dispensador de zumo
distributeur à jus de fruit



Edelstahl-Crasheisröhre herausnehmbar

stainless steel crash ice tube
con tubo inox refrigerante extraíble para hielo picado
avec tube inox réfrigérant amovible pour glace pilée

	cm	↑ cm	ltr.	€
10795	36 x 26	55	8	169,00



Saftdispenser DUO „INOX STAR“

juice dispenser
dispensador de zumo
distributeur à jus de fruit



Edelstahl-Crasheisröhre herausnehmbar

stainless steel crash ice tube
con tubo inox refrigerante extraíble para hielo picado
avec tubes inox réfrigérants amovibles pour glace pilée

	cm	↑ cm	ltr.	€
10810	36 x 52	55	2 x 8	339,00

Behälter / container / recipiente / récipient

	Ø cm	ltr.	€
10796	22	8	35,70

Deckel 18/10 Edelstahl hochglanzpoliert / cover 18/10 stainless steel mirror polished finish / tapa 18/10 inox pulido brillante / couvercle inox 18/10 poli brillant

10797	29,80
-------	-------

Crasheisröhre / crash ice tube / tubo para hielo picado / tube pour glace pilée

10798	23,80
-------	-------

Non-Drip Hahn / non-drip-tap / grifo anti-goteo / robinet anti-goutte

10799	22,00
-------	-------

Dichtungsring / sealing ring / arandela / rondelle

10793	1,50
-------	------

Silikondichtung / sealing / junta / joint

10794	2,00
-------	------





Isolierkanne „ECONOMY“

vacuum jug
jarra termo
bouteille isotherme



robuste Umhüllung mit Polypropylen-Kunststoff, Stabilglaseinsatz, Drehverschluss mit Drucktasten-Bedienung für heiße und kalte Getränke, 8 Tassen

double-walled with glass liner, screw cap with easy push-button pouring system, for hot and cold beverages, 8 cups

exterior de plástico polipropileno, interior aislante de vidrio, con tapa a rosca con cierre dosificador para bebidas frías y calientes, 8 tazas

extérieur en plastique polypropylène, intérieur avec plaque de verre, couvercle à visser, pour boissons chaudes ou froides, 8 tasses

	Ø cm	↑ cm	ltr.	Farbe / Colour	€
10913	16	20	1,0		13,60
10914	16	20	1,0		13,60



Pump-Isolierkanne „PREMIUM“

air pot
jarra termo
bouteille isotherme



doppelwandig, Tragegriff, drehbarer Fuß, Pumpmechanismus und Füllstandsanzeige sind leicht zu reinigen mit 4 unterschiedlichen Inhaltsbeschriftungen für den Pumphebel (coffee, tea, hot water, decaf), aufgeklappt passt die Kanne unter die gängigen Kaffeemaschinen, für heiße und kalte Getränke

double-walled, carrying handle, pivotable feet, pump mechanism and fill level indicator is easily removable for cleaning, includes 4 different beverage signs (coffee, tea, hot water, decaf), with flipped-back lid, the air pot fits under a wide range of coffee makers, for hot and cold beverages

doble pared, con asa al lateral, pié girable, el mecanismo a presión y el indicador óptico del nivel son fácil de limpiar, con 4 etiquetas diferentes para la palanca (coffee, tea, hot water, decaf), con la tapa abierta la jarra se puede usar con casi todas las cafeteras corrientes, para bebidas frías y calientes

double paroi, avec poignée, pied pivotant, le mécanisme a pression et l'indicateur de niveau sont facile à retirer pour le nettoyage, avec 4 étiquettes différents pour la pompe (coffee, tea, hot water, decaf), avec la couvercle ouverte la bouteille se peut user avec toutes les machines à café courantes, pour boissons chaudes ou froides

	Ø cm	↑ cm	ltr.	Anzahl der Tassen	€
10916	15	37,0	3,0	24	60,00

Tropfenfänger für Pump-Isolierkanne / drip tray for air pot / recoge-gotas para jarra termo / ramasse-gouttes pour bouteilles isotherme

	cm	↑ cm	€
10917	24,0 x 18,5	4	9,40



Pump-Isolierkanne „BUDGET“

air pot
jarra termo
bouteille isotherme



doppelwandig, Tragegriff, Dreh-Pumpknopf zur leichten Bedienung (close/open), Pumpmechanismus ist leicht zu entnehmen und zu reinigen, aufgeklappt passt die Kanne unter die gängigen Kaffeemaschinen, für heiße und kalte Getränke

double-walled, carrying handle, rotatable Push-Button for easy use (close/open), pump mechanism is easily removable for cleaning, with flipped-back lid, the air pot fits under a wide range of coffee makers, for hot and cold beverages

doble pared, con asa al lateral, tapa girable y a presión para uso fácil (close/open), el mecanismo a presión es fácil de retirar para limpiar, con la tapa abierta la jarra se puede usar con casi todas las cafeteras corrientes, para bebidas frías y calientes

double paroi, avec poignée, couvercle à visser et a pression pour facile usage (close/open), le mécanisme a pression est facile à retirer pour le nettoyage, avec la couvercle ouverte la bouteille se peut user avec toutes les machines à café courantes, pour boissons chaudes ou froides

	Ø cm	↑ cm	ltr.	Anzahl der Tassen	€
10915	13,5	32,5	2,2	17	21,00



Isolierkanne „ADVANCED“

vacuum jug
jarra termo
bouteille isotherme



doppelwandig, spülmaschinenfest, Einhandautomatik, aufgeklappt passt die Kanne unter die gängigen Kaffeeautomaten, für heiße und kalte Getränke

double-walled, dishwasher-safe, easy pouring system, with flipped-back lid, the air pot fits under a wide range of coffee makers, for hot and cold beverages

doble pared, resistente al lavavajillas, se maneja con 1 mano, con la tapa abierta la jarra se puede usar con casi todas las cafeteras corrientes, para bebidas frías y calientes

double paroi, résistante au lave-vaisselle, usage à 1 main, avec la couvercle ouverte la bouteille se peut user avec toutes les machines à café courantes, pour boissons chaudes ou froides

	Ø cm	↑ cm	ltr.	Anzahl der Tassen	€
10921	10,5	13	0,3	2,5	34,00
10922	10,5	18	0,6	5	40,00
10923	13,0	19,5	1,0	8	44,00
10924	13,0	23,5	1,5	12	49,00



Isolierkanne „CLASSIC“

vacuum jug
jarra termo
bouteille isotherme



doppelwandig, Einhandautomatik, Drehverschluss, für heiße und kalte Getränke

double-walled, easy push-button pouring system, screw cap, for hot and cold drinks

doble pared, se maneja con 1 mano, con tapa a rosca, para bebidas frías y calientes

double paroi, usage à 1 main, couvercle à visser, pour boissons chaudes ou froides

	Ø cm	↑ cm	ltr.	Anzahl der Tassen	€
10910	14	19	1,0	8	15,00
10911	14	22	1,5	12	17,00
10912	14	25	2,0	16	19,00

Buffetständer

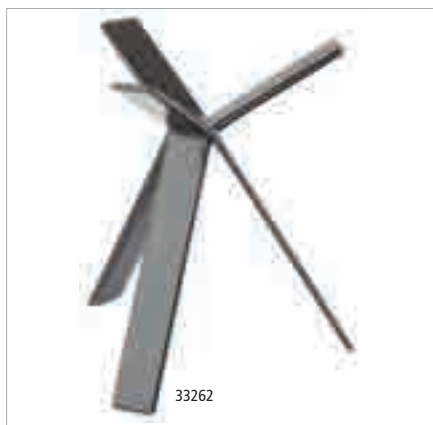

Buffetständer „STAR“

buffet stand
soporte para bufé
présentoir buffet



Metall, mit schwarzer Antirutschgummierung
metal, with black anti-slide coating
acero cromado, con recubrimiento negro antideslizante
metal avec revêtement plastique noir antiglisse

	↑ cm	€
33260	8	14,00
33261	12	16,50
33262	18	18,90



Buffetständer „MULTI ROUND“

buffet stand
soporte para bufé
présentoir buffet



Metall, mit schwarzer Antirutschgummierung
metal, with black anti-slide coating
acero cromado, con recubrimiento negro antideslizante
metal avec revêtement plastique noir antiglisse

	Ø cm	↑ cm	€
33269	15,5 / 18	8	10,00
33270	15,5 / 18	10	12,00
33271	15,5 / 18	18	15,00

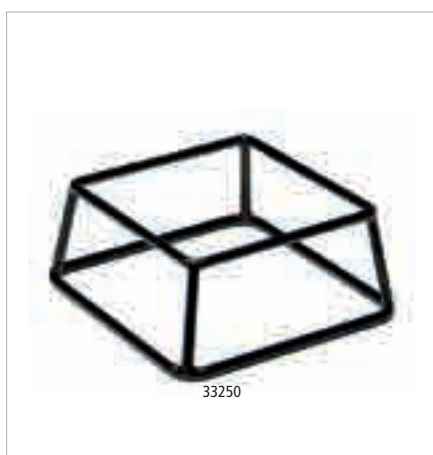

Buffetständer „MULTI“

buffet stand
soporte para bufé
présentoir buffet



Metall, mit schwarzer Antirutschgummierung
metal, with black anti-slide coating
acero cromado, con recubrimiento negro antideslizante
metal avec revêtement plastique noir antiglisse

	cm	↑ cm	€
33249	18 x 18	5	9,00
33250	18 x 18	8	12,40
33251	18 x 18	10	15,00
33252	18 x 18	18	17,50

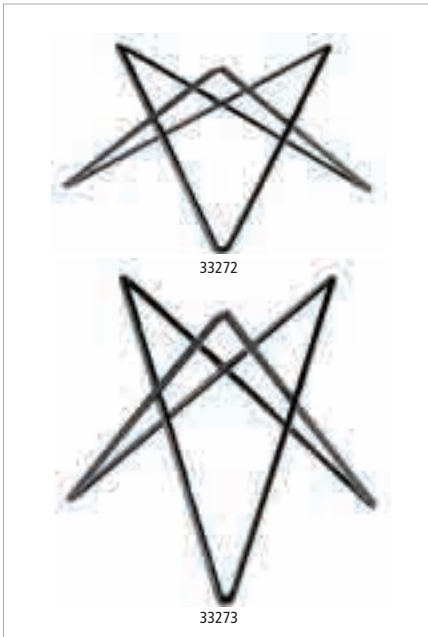

Buffetständer „PRISMA“

buffet stand
soporte para bufé
présentoir buffet



Metall, mit schwarzer Antirutschgummierung
metal, with black anti-slide coating
acero, con recubrimiento negro antideslizante
metal, revêtement plastique noir antiglisse

	Ø cm	↑ cm	€
33272	20	10,5	9,00
33273	20	20	13,00



Buffetständer „WOOD“

buffet stand
soporte para bufé
présentoire buffet



Akazienholz, liegend oder stehend, variable Nutzungsmöglichkeiten

acacia wood, usable by lying or standing, there are variable usage possibilities
madera de acacia, se puede usar tumbado o de pie, hay diferentes opciones de utilizar
bois d'accacia, il y a différentes possibilités d'usage

	cm	↑ cm	Farbe / Colour	€
33280	20 x 20	17,5		9,00
33281	20 x 20	17,5		9,00



liegend oder stehend, variable Nutzungsmöglichkeiten
vertically or horizontally, there are variable usage possibilities



Buffetständer

buffet stand
expositor de bufé
présentoir buffet



Akazienholz
acacia wood
madera de acacia
bois d'accacia

	Ø cm	↑ cm	€
33255	15	10	14,00
33256	25	15	17,00

Buffet & Display



Buffetständer „ASIA PLUS“

buffet stand
soporte para bufé
présentoir buffet



	Ø cm	↑ cm	Farbe / Colour	€
15515	38,0	16,5	■	19,00
15516	38,0	27,0	■	22,00
15517	48,5	16,5	■	22,00
15518	48,5	27,0	■	29,00



Buffetständer „ASIA PLUS“

buffet stand
soporte para bufé
présentoir buffet



	Ø cm	↑ cm	Farbe / Colour	€
15519	38,0	16,5	■	16,00
15520	38,0	27,0	■	19,00
15521	48,5	16,5	■	19,00
15522	48,5	27,0	■	26,00

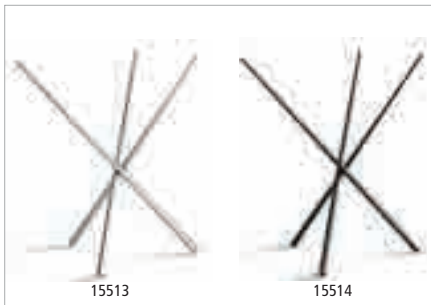

Buffetständer „ASIA PLUS“

buffet stand
soporte para bufé
présentoir buffet



	Ø cm	↑ cm	Farbe / Colour	€
15513	20,5 / 16,5	20	■	15,00
15514	20,5 / 16,5	20	■	14,00



Buffetständer „KING“

buffet stand
soporte para bufé
présentoir buffet



kein Verrutschen, Arme und Boden sind mit Antirutschflächen ausgestattet, schwere standsichere Qualität, Fuß dient als Löffelablage

the arms and base are equipped with non-slip surfaces, stable quality, base serves as spoon holder
anti-deslizante: revestimiento antideslizante en las puntas de los brazos y en la base, estable y alta calidad, la base sirve como reposacuchara

antiglisse: revêtement antidérapant sur les extrémités des 3 pieds et sur la base, robuste, stable et bonne qualité, la base sert de support pour les couverts

	Ø cm	↑ cm	€
03622	15	14	36,00
03623	15	21	39,60



Buffet-Tower

Buffet-Tower
torre para bufé
tour carrée pour le buffet



3-stufig, Glas in Spiegeloptik, Holz Birke dunkelbraun, Lieferung demontiert

with beech wood pillar, tempered glass mirror surface, each in knock-down packing

3 pisos, vidrio templado, eje central de madera oscura, se entrega desmontado

3 étages, verre trempé, axe central carré en bois foncé, livré non-monté

	cm	↑ cm	€
12415	25 x 25	30,5	55,00



High Tea Rack

High Tea Rack
rack de te alto
étagère à thé avec anse supérieure



Holz dunkelbraun, Edelstahlgriff, 4 große Fächer 15 x 10 x 10 cm,
3 kleine Fächer 9,5 x 9,5 x 10 cm

rubber wood in dark brown, stainless handle, 4 big compartments 15 x 10 x 10 cm, 3 small compartments 9,5 x 9,5 x 10 cm

madera marrón oscura, mango de acero inoxidable, 4 compartimentos grandes 15 x 10 x 10 cm, 3 compartimentos pequeños 9,5 x 9,5 x 10 cm

bois marron foncé, poignée inox, 4 compartiment grand 15 x 10 x 10 cm, 3 compartiment petit 9,5 x 9,5 x 10 cm

	cm	↑ cm	€
33210	34 x 10	38	33,00

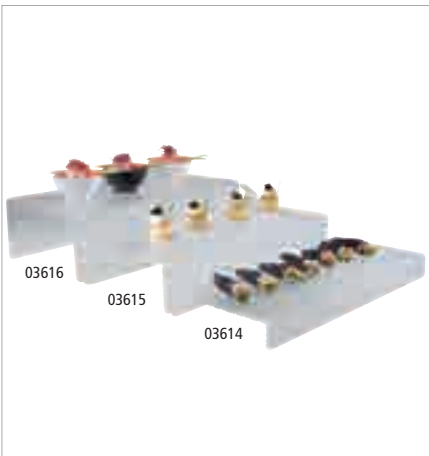

Stufen-Display

tier display
expositor en escalera
présentoir en escalier



mit Schieferstruktur

with slate structure

con relieve tipo pizarra

avec relief irrégulier type ardoise

	cm	↑ cm	€
03614	40 x 18	4	20,00
03615	40 x 20	8	24,80
03616	40 x 22	12	27,80



Stufen-Display, 3-tlg.

tier display, 3 pcs.
expositor en escalera, 3 piez.
présentoir en escalier, 3 pcs.



3-teiliges Set: 03614 + 03615 + 03616

3 pcs. set: 03614 + 03615 + 03616

set de 3 piezas: 03614 + 03615 + 03616

set 3 pièces: 03614 + 03615 + 03616

	cm	↑ cm	€
03617	40 x 18 / 40 x 20 / 40 x 22	4 / 8 / 12	71,50



Stufen-Display, 3-tlg.

tier display, 3 pcs.
expositor en escalera, 3 piez.
présentoir en escalier. 3 pcs.



3-teiliges Set: 03618 + 03619 + 03620

3 pcs. set: 03618 + 03619 + 03620

set de 3 piezas: 03618 + 03619 + 03620

set 3 pièces: 03618 + 03619 + 03620

	cm	↑ cm	€
03621	20 x 18 / 20 x 20 / 20 x 22	4 / 8 / 12	42,40

Buffet & Display



Buffetgestell „LIGHT HOUSE“

buffet stand
soporte para buffet
présentoir buffet



Gestell aus Metall schwarz, inkl. 4 Glasplatten
frame made of metal, incl. 4 glass plates
soporte metálico, incl. 4 placas de vidrio
support métallique, avec 4 plaques de verre

	Ø cm	↑ cm		€
11660	33	62	4-stufig / 4-tier / 4 alturas / 4 niveaux	44,00

Ersatz-Glasplatten / spare glass / fuente de recambio vidrio / plat de rechange en verre

	Ø cm			€/Set
11653	12 / 20,5 / 25,0 / 30,5		bestehend aus 4 Glasplatten 4er Set / 4 pcs. set / set de 4 / set de 4	14,00

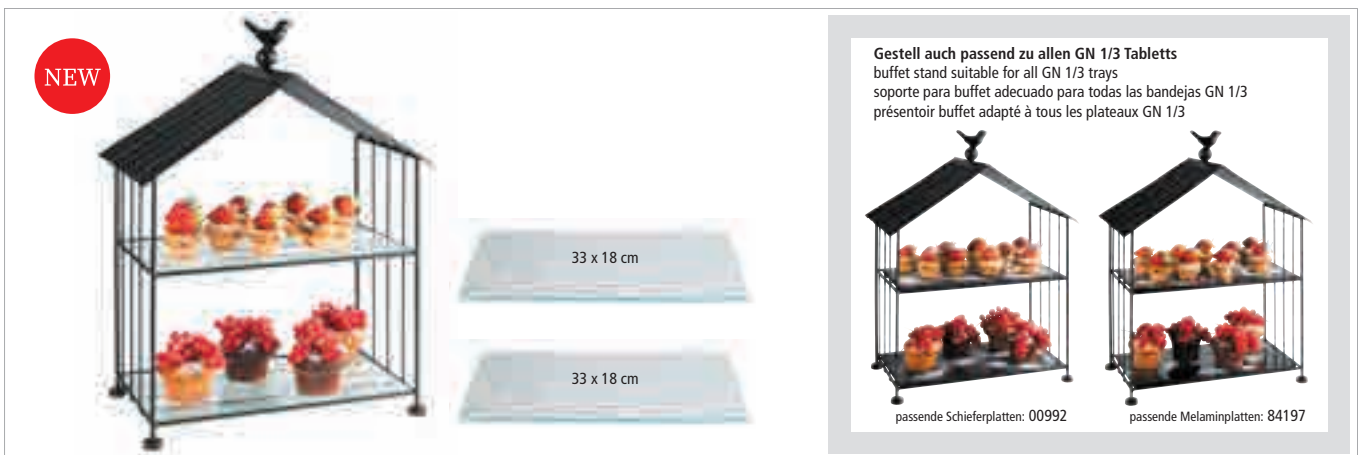

Buffetgestell „BIRD“

buffet stand
soporte para buffet
présentoir buffet



Gestell aus Metall schwarz, inkl. 2 Glasplatten je 33 x 18 cm
frame made of metal, incl. 2 glass plates, each 33 x 18 cm
soporte metálico, incl. 2 placas de vidrio, cada una 33 x 18 cm
support métallique, avec 2 plaques de verre, chacun 33 x 18 cm

	cm	↑ cm	fits to GN		€
11661	37,5 x 21,0	50	1/3-trays	2-stufig / 2-tier / 2 alturas / 2 niveaux	44,00

Ersatz-Glasplatten / spare glass / fuente de recambio vidrio / plat de rechange en verre

	cm			€/Set
11654	33,0 x 18,0		bestehend aus 2 Glasplatten 2er Set / 2 pcs. set / set de 2 / set de 2	16,00



Buffettisch „MINI“
buffet stand
soporte para buffet
présentoir buffet



	cm	↑ cm	fits to	€
11624	40,0 x 21,5	15	GN 1/3 trays	19,00



Buffettisch „MINI VINTAGE“
buffet stand
soporte para buffet
présentoir buffet



	cm	↑ cm	fits to	€
11634	40,0 x 21,5	15	GN 1/3 trays	19,00



Buffetgestell „TRIANGLE“
buffet stand
expositor de buffet
présentoir à céréales



	cm	↑ cm		€
13966	53 x 21	50	Ahorn / maple	136,00



Buffetgestell „TRIANGLE“
buffet stand
expositor de buffet
présentoir à céréales



	cm	↑ cm		€
14966	53 x 21	50	Wenge / wenge	136,00

Buffet & Display



Untersetzer „BAMBOO“

coaster
posavasos
soucoupes



	~ cm	↑ cm	€
00890	53,0 x 32,5	3,0	10,00
00891	35,4 x 32,5	3,0	7,40
00892	53,0 x 16,2	3,0	7,20
00893	26,5 x 16,2	3,0	4,20
00894	32,5 x 26,5	3,0	6,40

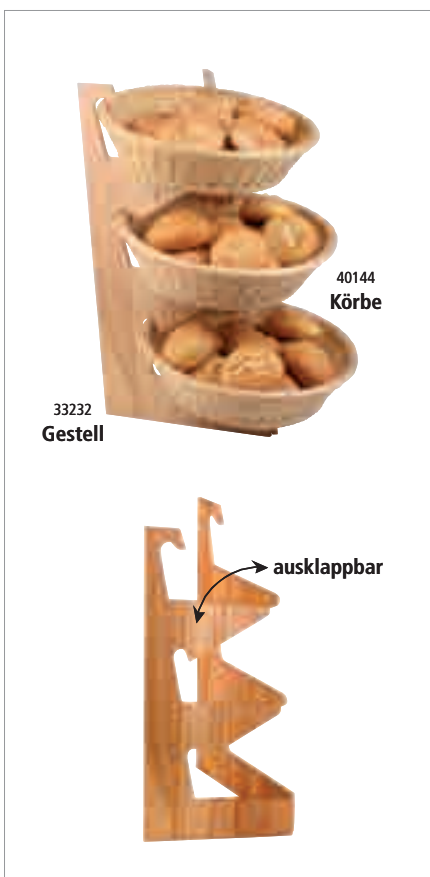

Buffetgestell

buffet stand
soporte para bufé
présentoir buffet



3-stufig, geeignet für runde und rechteckige Körbe, platzsparend zusammenklappbar, Lieferung ohne Körbe

3-tier, usable for round and rectangular baskets, can be pushed together for place saving, delivery without baskets

3 alturas, apto para cestas redondas y rectangulares, se puede plegar para ahorrar espacio, se entrega sin cestas

3 hauteurs, pour corbeilles rondes ou rectang, la structure s'ouvre ou se ferme pour réduire l'encombrement, livré sans corbeilles

	cm	↑ cm	€
33232	59 x 30,5	59	18,50

Tisch- und Buffetkorb, rund „ECONOMIC“ / buffet basket, round / cesta de bufé redonda / corbeille de buffet ronde

	Ø cm	↑ cm	Farbe / Colour	€
40144	39,0	10,0		13,80

Korb „GN LINE“ / GN basket / GN cesta / GN corbeille

	cm	↑ cm	Farbe / Colour	€
40240	53 x 32,5	10		21,90
40270	53 x 32,5	10		21,90



Buffetgestell, 3-tlg.

buffet stand, 3 pcs.
expositor de buffet, set de 3
présentoir buffet, set de 3



3-teilig:

- 1. Fach 40 x 23 cm x H 33 cm;
- 2. Fach 40 x 20,5 cm x H 20 cm;
- 3. Fach 40 x 18 cm x H 9 cm

3 pcs. set: 40 x 23 cm x H 33 cm; 40 x 20,5 cm x H 20 cm; 40 x 18 cm x H 9 cm
set de 3: 40 x 23 cm x H 33 cm; 40 x 20,5 cm x H 20 cm; 40 x 18 cm x H 9 cm
set de 3: 40 x 23 cm x H 33 cm; 40 x 20,5 cm x H 20 cm; 40 x 18 cm x H 9 cm

	cm	↑ cm	Farbe / Colour		€
11606	40 x 23	33	■	Wenge	149,00



Buffetgestell, 3-tlg.

buffet stand, 3 pcs.
expositor de buffet, set de 3
présentoir buffet, set de 3



3-teilig:

- 1. Fach 40 x 40 cm x H 33 cm;
- 2. Fach 40 x 37 cm x H 20 cm;
- 3. Fach 40 x 34 cm x H 9 cm

3 pcs. set: 40 x 40 cm x H 33 cm; 40 x 37 cm x H 20 cm; 40 x 34 cm x H 9 cm
set de 3: 40 x 40 cm x H 33 cm; 40 x 37 cm x H 20 cm; 40 x 34 cm x H 9 cm
set de 3: 40 x 40 cm x H 33 cm; 40 x 37 cm x H 20 cm; 40 x 34 cm x H 9 cm

	cm	↑ cm	Farbe / Colour		€
11607	40 x 40	33	■	Wenge	189,00

Buffet & Display



Etagère „ROYAL“

etagère
expositor
présentoir



5-teilig: 3 Edelstahl-Schalen + 2 Gestelle, einfach übereinanderstellen, einzeln nutzbar

5 pcs. set: 3 bowls + 2 frames, easy to assemble, single usable

set de 5 piezas: 3 bols + 2 soportes, fácil de montar

5 éléments: 3 bols + 2 supports, montage facile

	Ø cm	↑ cm	€
24336	24 / 33 / 42	43,5	157,00

Schale / bowl / fuente / plateau

	Ø cm	↑ cm	ltr.	€
24330	24	3	0,6	23,80
24331	33	4	1,3	37,00
24332	42	5	2,5	57,00

Gestell einzeln / stand alone / pie soporte / pied seul

	Ø cm	↑ cm	€
24338	18	19	9,90
24339	24	20	14,00



Etagère „ROYAL“

etagère
estante
présentoir



3-teilig: 2 Edelstahl-Schalen + 1 Gestell, einfach übereinanderstellen, einzeln nutzbar

3 pcs. set: 2 bowls + 1 frame, easy to assemble, single usable

set de 3 piezas: 2 bols + 1 soporte, fácil de montar

3 éléments: 2 bols + 1 support, montage facile

	Ø cm	↑ cm	€
24335	33 / 42	25	106,00
24334	24 / 33	22	67,00

Schale / bowl / fuente / plateau

	Ø cm	↑ cm	ltr.	€
24330	24	3	0,6	23,80
24331	33	4	1,3	37,00
24332	42	5	2,5	57,00

Gestell einzeln / stand alone / pie soporte / pied seul

	Ø cm	↑ cm	€
24338	18	19	9,90
24339	24	20	14,00



Etagère

etagère
frutero
corbeille à fruits



ergonomischer Griff, stehend auf schwarzen Antirutsch-Füßen

ergonomic handle, anti-slip-feet

asa ergonómica, pies antideslizantes color negro

anse ergonomique, pieds antidérapants noirs

	cm	↑ cm	€
30325	30 x 30	35,5	11,80

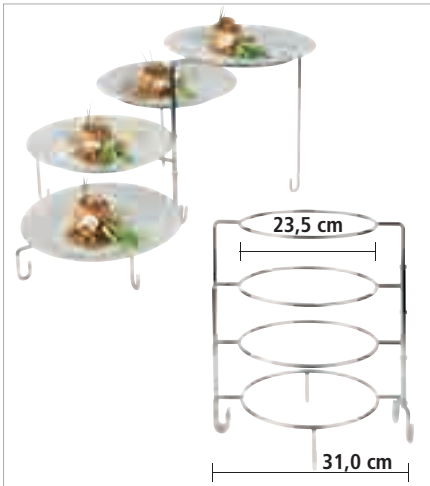

Serviergestell

servicing stand
soporte platos
présentoir à assiettes



für 4 Teller (max. Ø 31 cm), platzsparend zusammendrehbar, Lieferung ohne Teller
for 4 plates (max. Ø 31 cm), can be pushed together for place saving, without dishes
para 4 platos (max. Ø 31 cm) se puede plegar para ahorrar espacio, se sirve sin platos
pour 4 assiettes (maxi Ø 31 cm), peut se refermer pour réduire l'encombrement, livré sans assiettes

	Ø cm	↑ cm	€
33225	34	37	62,00

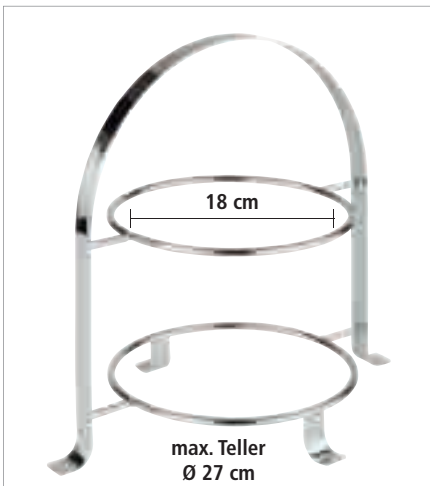

Serviergestell

servicing stand
soporte platos
présentoir à assiettes



für 2 Teller max. Ø 27 cm, innerer Ring Ø 18 cm, Lieferung ohne Teller
for 2 plates max. Ø 27 cm, circle inside Ø 18 cm, without dishes
para 2 platos Ø 27 cm, interior aro Ø 18 cm, se entrega sin platos
pour 2 assiettes maxi Ø 27 cm, cercle Ø int. 18 cm, livré sans assiettes

	cm	↑ cm	€
33214	33 x 23,5	30	32,00



Serviergestell

servicing stand
soporte platos
présentoir à assiettes



für 3 Teller max. Ø 17 cm, innerer Ring Ø 10,5 cm
for 3 plates max. Ø 17 cm, circle inside Ø 10,5 cm
para 3 platos Ø 17 cm, interior aro Ø 10,5 cm
pour 3 assiettes maxi Ø 17 cm, cercle Ø int. 10,5 cm

	cm	↑ cm	€
33216	22,5 x 16,5	25,5	25,00



Serviergestell

servicing stand
soporte platos
présentoir à assiettes



für 3 Teller max. Ø 27 cm, innerer Ring Ø 18 cm
for 3 plates max. Ø 27 cm, circle inside Ø 18 cm
para 3 platos Ø 27 cm, interior aro Ø 18 cm
pour 3 assiettes maxi Ø 27 cm, cercle Ø int. 18 cm

	cm	↑ cm	€
33217	33 x 24	43	40,00

Buffet & Display

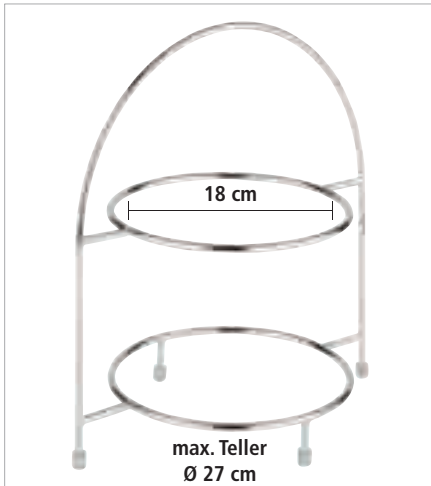

Serviergestell

serving stand
soporte platos
présentoir à assiettes



für 2 Teller max. Ø 27 cm, innerer Ring Ø 18 cm
for 2 plates max. Ø 27 cm, circle inside Ø 18 cm
para 2 platos Ø 27 cm, interior aro Ø 18 cm
pour 2 assiettes maxi Ø 27 cm, cercle Ø int. 18 cm

	cm	↑ cm	Farbe / Colour	€
33219	29 x 19,5	30		26,20



Serviergestell

serving stand
soporte platos
présentoir à assiettes



für 3 Teller max. Ø 17 cm, innerer Ring Ø 10,5 cm
for 3 plates max. Ø 17 cm, circle inside Ø 10,5 cm
para 3 platos Ø 17 cm, interior aro Ø 10,5 cm
pour 3 assiettes maxi Ø 17 cm, cercle Ø int. 10,5 cm

	cm	↑ cm	Farbe / Colour		€
33215	18,5 x 15,5	26		chrome	20,00
33211	18,5 x 15,5	26		copper	22,00



Serviergestell

serving stand
soporte platos
présentoir à assiettes



für 3 Teller max. Ø 27 cm, innerer Ring Ø 18 cm
for 3 plates max. Ø 27 cm, circle inside Ø 18 cm
para 3 platos Ø 27 cm, interior aro Ø 18 cm
pour 3 assiettes maxi Ø 27 cm, cercle Ø int. 18 cm

	cm	↑ cm	Farbe / Colour		€
33220	29 x 19,5	43		chrome	34,00
33212	29 x 19,5	43		copper	36,00



Etagère

etagère
frutero
présentoir à fruits



hochglanzpoliert, Edelstahl-Schale herausnehmbar
mirror polished finish, bowl removable
acabado brillante, bandeja inferior suelta
effet brillant, bol inférieur amovible

	Ø cm	↑ cm		€
33235	27,5	32		62,00
33240	32	53		97,00



Serviergestell

serving stand
expositor
présentoir



3-stufig für quadratische Teller / Platten in 3 verschiedenen Größen:
z.B. 83407 + 83406 + 83405, Lieferung ohne Teller/Platten

3-tier for square dishes / plates in 3 different sizes: e.g. 83407 + 83406 + 83405,
delivery without dishes / plates

3 alturas para platos cuadrados fuentes en 3 diferentes medidas p.e. 83407 + 83406 + 83405,
se entrega sin platos/ fuentes

3 niveaux pour assiettes ou plats carrés de différentes dimensions, ex. 83407 + 83406 + 83405,
livré sans assiettes

	cm	↑ cm	€
33231	37,5 x 37,5	50	87,00



Etagère „CASUAL“

etagère
expositor de bombones o bocaditos
présentoir à mignardises



inklusive Edelstahl-Schild, beschriftbar

including sign

placa incluida, sin inscripción

étiquette incluse, sans inscription

	Ø cm	↑ cm		€
34248	31 - 41 - 51	55	3-stufig / 3-tier 3 niveles / 3 étages	109,00
34247	31 - 41	35	2-stufig / 2-tier 2 niveles / 2 étages	66,00



Etagère „FINESSE“

etagère
frutero
étagère



vergoldeter Messing-Kugelgriff, einfache Montage

gold plated knob, easy to assemble

botón dorado, fácil de montar

bouton doré, montage facile

	Ø cm	↑ cm		€
33248	48 / 38 / 32	50	3-stufig / 3-tier 3 alturas / 3 niveaux	95,00
33238	38 / 32	30	2-stufig / 2-tier 2 alturas / 2 niveaux	58,00



3-stufige Etagère

3-tier tray
bandeja con tres alturas
étagère carré 3 hauteurs



Naturschiefer, Akazienholz

natural slate tray, wood akazie

bandeja de pizarra natural, madera

plateau ardoise naturelle, bois

	Ø cm	↑ cm	✂ mm	€
00960	30 / 25 / 20	34	6 - 9	26,00

Buffet & Display



2-stufige Etagère 2 tier tray bandeja dos alturas plat carré 2 hauteurs

Naturschiefer
natural slate tray
bandeja de pizarra natural
plateau ardoise naturelle



	Ø cm	↑ cm	✱ mm	€
00989	25 / 20	24	6 - 9	13,20



Etagère etagère expositor présentoir à petits fours



	Ø cm	↑ cm	€
00193	14 / 11	16	4,80



Brezel- oder Wurstständer pretzel-/ sausage stand soporte para embutidos support à bretzel ou à saucissons



Verkaufsständer Buchen-Holz versiegelt, bestens geeignet für die Präsentation von Brezeln, Würstchen, etc., Fuß Ø 22 cm

beech wood, ideal to present pretzels, sausages, etc.
madera de haya, ideal para presentar fiambres, salchichones etc.
en hêtre, idéal pour bretzels ou saucissons, etc.

	Ø cm	↑ cm	€
79553	28	50	19,00

Hygieneschutz für Brezelständer / hygienic cover / cubierta higiénica antialiento / pare-haleine

	cm	↑ cm	€
11557	20 x 20 x 20	50	21,00
11558	15 x 20 x 15	50	19,00



Serviergestell, 2-stufig serving stand, 2-tier soporte platos, 2 alturas présentoir, 2 hauteurs



3 tlg. Set, 1 Gestell aus Akazienholz, 2 Schieferplatten, zusammenklappbar

3 pcs. set, 1 stand acacia wood, 2 slate tray, foldable
set de 3 piezas, 1 soporte madera de acacia, 2 bandeja de pizarra, fácil de plegar
set de 3 pièces, 1 présentoir au pour tous les seaux à FRAMES

	cm	↑ cm	€
00958	36,5	34 x 26,5	32,00



**zusammenklappbar
foldable**



Serviergestell „FLEXIBEL“

serving stand
expositor
présentoir



3-stufig „beweglich / drehbar“, platzsparend zerlegbar
3 tier, flexible frame, space saving
3 alturas, marco flexible, ahorra espacio
3 hauteurs, cadre souple, gagne de la place

	cm	↑ cm	€
33243	45,5 x 32	21,5	48,00

Tablett „PURE COLOR“ / tray / bandeja / plateau

	cm	↑ cm	Farbe / Colour	€
83403	35,5 x 18,0	3		12,00
83566	35,5 x 18,0	3		12,00
83567	35,5 x 18,0	3		12,00



Tablett „PURE“

tray
bandeja
plateau



Edelstahl matt poliert, passend für Melamin-Schalen
stainless steel satin polished finish, for melamin bowls
acero inoxidable mate, apta para cuencos de melamina
inox mat, concient pour bols mélamine

	cm		€
30120	20 x 11	für 2 Schalen / for 2 bowls para 2 cuencos / pour 2 bols	6,40
30122	20 x 20	für 4 Schalen / for 4 bowls para 4 cuencos / pour 4 bols	10,50
30121	29 x 20	für 6 Schalen / for 6 bowls para 6 cuencos / pour 6 bols	13,20



Schale „PURE COLOR“

bowl
cuenco
bol



	cm	↑ cm	Farbe / Colour	€
83414	9,0 x 9,0	4,0		3,40
83466	9,0 x 9,0	4,0		3,40
83568	9,0 x 9,0	4,0		3,40
83569	9,0 x 9,0	4,0		3,40



Serviergestell „S-PURE“

serving stand
soporte bufé
support buffet



für 3 Tablett quadratisch 83407 oder 83418
for 3 trays square 83407 or 83418
para 3 bandejas cuadradas 83407 o 83418
pour 3 plats carrés 83407 ou 83418

	cm	↑ cm	€
33226	29 x 17	41	40,00



Serviergestell „M-PURE“

serving stand
soporte bufé
support buffet



für 3 Tablett quadratisch 83406 oder 83407
for 3 trays square 83406 or 83407
para 3 bandejas cuadradas 83406 o 83407
pour 3 plats carrés 83406 o 83407

	cm	↑ cm	€
33227	33 x 21	44	49,00



Serviergestell „L-PURE“

serving stand
soporte bufé
support buffet



für 3 Tablett rechteckig 83417
for 3 trays rectangular 83417
para 3 bandejas rectangulares 83417
pour 3 plats rectangulaires 83417

	cm	↑ cm	€
33228	37 x 21	44	52,50



GN Serviergestell „XL-PURE“

GN serving stand
GN soporte bufé
GN support buffet



passend für Tablett GN 1/1, GN 1/2, GN 1/3, GN 2/4
suitable for tray GN 1/1, GN 1/2, GN 1/3, GN 2/4
aptas para bandejas GN 1/1, GN 1/2, GN 1/3, GN 2/4
convient pour les plats GN 1/1, GN 1/2, GN 1/3, GN 2/4

	cm	↑ cm	€
33222	63 x 27	44,5	69,00



Buffetgestell „FLOAT SMALL“

buffet stand
soporte bufé
support buffet



Metall verchromt, für 3 Schalen Nr. 83916, 83917
metal chrome plated, for 3 bowls no. 83916, 83917
metal cromado, para 3 cuencos N° 83916, 83917
métal chromé, pour 3 coupelles 83916, 83917

	cm	↑ cm	€
33241	55,5 x 19	15,5	37,00

Schale „FLOAT“ / bowl / cuenco / bol

	cm	↑ cm	Farbe / Colour	€
83916	19 x 19	9,5	White	14,20
83917	19 x 19	9,5	Black	14,20



Buffetgestell „FLOAT BIG“

buffet stand
soporte bufé
support buffet



Metall verchromt, für 3 Schalen Nr. 83914, 83915, für 1 Schale Nr. 83918, 83919
metal chrome plated, for 3 bowls no. 83914, 83915, for 1 bowl no. 83918, 83919
metal cromado, para 3 cuencos N° 83914, 83915, para 1 cuenco N° 83918, 83919
métal chromé, pour 3 coupelles 83914, 83915 ou 1 bol 83918, 83919

	cm	↑ cm	€
33242	39 x 39	17	58,00

Schale „FLOAT“ / bowl / cuenco / bol

	cm	↑ cm	Farbe / Colour	€
83914	12,5 x 12,5	6,0	White	6,00
83918	25 x 25	12,0	White	26,00
83915	12,5 x 12,5	6,0	Black	6,00
83919	25 x 25	12,0	Black	26,00

Buffetleiter GN



GN 1/3

Buffetleiter „LITTLE GN 1/3“
buffet ladder
dispensador en escalera
présentoir buffet en escalier



4-teilig: 1 Leiter-Gestell, 3 GN 1/3 Rahmen
4 pcs.: 1 ladder, 3 single rings GN 1/3
4 pz: 1 soporte escalera, 3 aros sencillos GN 1/3
4 pc: 1 support escalier, 3 cercles simples GN 1/3

	cm	↑ cm	fits to	€
11526	31,5 x 32	48	baskets / pans GN 1/3	68,00



N 1/2

Buffetleiter „LITTLE GN 1/2“
buffet ladder
dispensador en escalera
présentoir buffet en escalier



4-teilig: 1 Leiter-Gestell, 3 GN 1/2 Rahmen
4 pcs.: 1 ladder, 3 single rings GN 1/2
4 pz: 1 soporte escalera, 3 aros sencillos GN 1/2
4 pc: 1 support escalier, 3 cercles simples GN 1/2

	cm	↑ cm	fits to	€
11527	31,5 x 41,5	48	baskets / pans GN 1/2	82,00

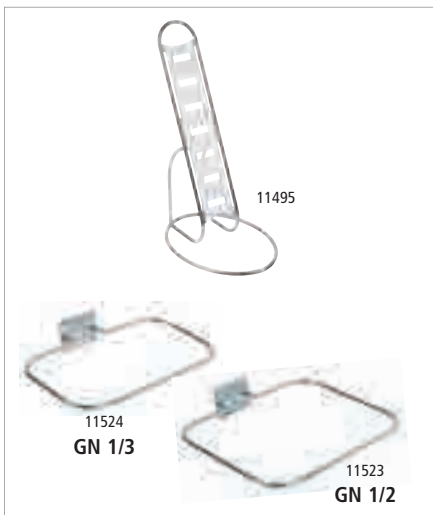

Einzelteile / spare parts / piezas sueltas / pièces détachées

Leitergestell / frame / marco solo en escalera / échelle support

11495	€	31,00
-------	---	-------

Einzelring GN 1/3 / single ring GN 1/3 / aro sencillo GN 1/3 / cercle simple GN 1/3

11524	€	13,50
-------	---	-------

Einzelring GN 1/2 / single ring GN 1/2 / aro sencillo GN 1/2 / cercle simple GN 1/2

11523	€	18,00
-------	---	-------



4 x GN 1/2

Buffetleiter „BIG GN 1/2“
buffet ladder
dispensador en escalera
présentoir buffet en escalier



5-teilig: 1 Leiter-Gestell, 4 GN 1/2 Rahmen
5 pcs.: 1 ladder, 4 single rings GN 1/2
5 pz: 1 soporte escalera, 4 aros sencillos GN 1/2
5 pc: 1 support escalier, 4 cercles simples GN 1/2

	cm	↑ cm	fits to	€
11528	31,5 x 56	66	baskets / pans GN 1/2	132,00



3 x GN 1/1

Buffetleiter „BIG GN 1/1“
buffet ladder
dispensador en escalera
présentoir buffet en escalier



4-teilig: 1 Leiter-Gestell, 3 GN 1/1 Rahmen
4 pcs.: 1 ladder, 3 single rings GN 1/1
4 pz: 1 soporte escalera, 3 aros sencillos GN 1/1
4 pc: 1 support escalier, 3 cercles simples GN 1/1

	cm	↑ cm	fits to	€
11529	52 x 59	66	baskets / pans GN 1/1	132,00

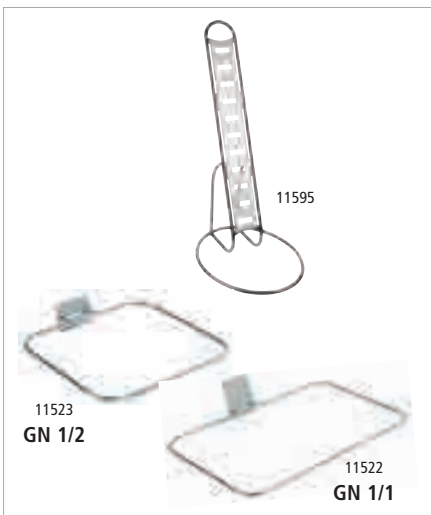

Einzelteile / spare parts / piezas sueltas / pièces détachées

Leitergestell / frame / marco solo en escalera / échelle support

11595	€ 60,00
-------	---------

Einzelring GN 1/2 / single ring GN 1/2 / aro sencillo GN 1/2 / cercle simple GN 1/2

11523	€ 18,00
-------	---------

Einzelring GN 1/1 / single ring GN 1/1 / aro sencillo GN 1/1 / cercle simple GN 1/1

11522	€ 25,00
-------	---------

Buffet & Display



jede Schale /
each bowl /
ca. 2,5 ltr.

Buffetleiter „BIG“

buffet ladder
dispensador en escalera
présentoir buffet en escalier



12-teiliges Set: 4 Glasschalen Ø 23 cm 2,5 Liter, 4 klappbare Schutzdeckel mit Beschriftungsfenster, 1 Leiter, 1 Doppelring, 2 Einzelringe, einfach und individuell zusammensetzbar

12 pcs. set: 4 glass bowls Ø 23 cm 2.5 litres, 4 hinged covers with card for inscription, 1 ladder, 1 double ring, 2 single rings, easy to fix and individual to use

set 12 pz: 4 boles vidrio Ø 23 cm 2,5 l, 4 tapas abatibles con ventana para etiqueta, 1 soporte escalera, 1 aro doble, 2 aros sencillos, fácil de montar, posible usar individualmente

12 éléments: 4 bols verre Ø 23 cm 2,5 l, 4 couvercles à charnière et fenêtre p/ étiquette, 1 support escalier, 1 cercle double, 2 cercles simples, montage facile, utilisable individuellement

	cm	↑ cm	€
11598	39 x 31	66	172,00



jede Schale /
each bowl /
ca. 2,5 ltr.

Buffetleiter „BIG“

buffet ladder
dispensador en escalera
Présentoir buffet en escalier



11-teiliges Set: 6 Glasschalen Ø 23 cm 2,5 Liter, 1 Leiter, 2 Doppelringe, 2 Einzelringe, einfach und individuell zusammensetzbar

11 pcs. set: 6 glass bowls Ø 23 cm 2.5 litres, 1 ladder, 2 double rings, 2 single rings, easy and individual to use

set 11 pz: 6 boles vidrio Ø 23 cm 2,5 l, 1 soporte escalera, 2 aros dobles, 2 aros sencillos, fácil montar, se puede usar individualmente

11 éléments: 6 bols verre Ø 23 cm 2,5 l, 1 support escalier, 2 cercles double, 2 cercles simples, montage facile, utilisable individuellement

	cm	↑ cm	€
11599	39 x 31	66	150,00

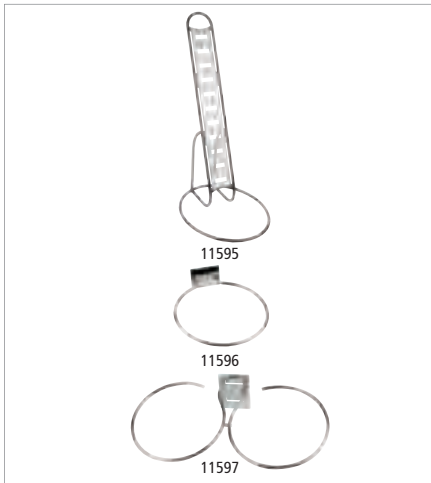

Einzelteile / spare parts / piezas sueltas / pièces détachées

Leitergestell / frame / marco solo en escalera / échelle support

11595	€ 60,00
-------	---------

Einzelring / single ring / aro sencillo / cercle simple

11596	€ 13,00
-------	---------

Doppelring / double ring / aro doble / cercle double

11597	€ 23,50
-------	---------



2,5 ltr.

Schale

bowl
cuenco
bol



	Ø cm	↑ cm	ltr.	€
11875	23	10,5	2,5	4,20



Schutzdeckel mit Löffelaussparung

cover
tapa
couvercle



	Ø cm	€
11878	23,5	11,40



jede Schale /
each bowl
ca. 0,5 ltr.

Buffetleiter „LITTLE“

buffet ladder
dispensador en escalera
présentoir buffet en escalier



12-teiliges Set: 4 Glasschalen Ø 14 cm 0,5 Liter, 4 klappbare Schutzdeckel mit Beschriftungsfenster, 1 Leiter, 1 Doppelring, 2 Einzelringe, einfach und individuell zusammensetzbar

12 pcs. set: 4 glass bowls Ø 14 cm 0.5 litres, 4 hinged covers with card for inscription, 1 ladder, 1 double ring, 2 single rings, easy and individual to use

set de 12 pz: 4 boles vidrio Ø 14 cm 0,5 l, 4 tapas abatibles con ventana para etiqueta, 1 soporte escalera, 1 aro doble, 2 aros sencillos, fácil montaje, se puede usar individualmente

12 éléments: 4 bols verre Ø 14 cm 0,5 l, 4 couvercles à charnière et fenêtre p/ étiquette, 1 support escalier, 1 cercle double, 2 cercles simples, montage facile, utilisable individuellement

	cm	↑ cm	€
11498	30 x 30	48	109,00



jede Schale /
each bowl
ca. 0,5 ltr.

Buffetleiter „LITTLE“

buffet ladder
dispensador en escalera
Présentoir buffet en escalier



11-teiliges Set: 6 Glasschalen Ø 14 cm 0,5 Liter, 1 Leiter, 2 Doppelringe, 2 Einzelringe, einfach und individuell zusammensetzbar

11 pcs. set: 6 glass bowls Ø 14 cm 0.5 litres, 1 ladder, 2 double rings, 2 single rings, easy and individual to use

set de 11 pz: 6 boles vidrio Ø 14 cm 0,5 l, 1 soporte escalera, 2 aros dobles, 2 aros sencillos, fácil montaje, se puede usar individualmente

11 éléments: 6 bols verre Ø 14 cm 0,5 l, 1 support escalier, 1 cercle double, 2 cercles simples, montage facile, utilisable individuellement

	cm	↑ cm	€
11499	30 x 30	48	94,00

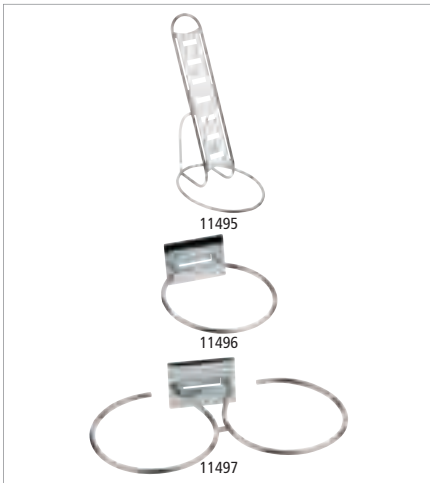

Einzelteile / spare parts / piezas sueltas / pièces détachées

Leitergestell / frame / marco solo en escalera / échelle support

11495	€ 31,00
-------	---------

Einzelring / single ring / aro sencillo / cercle simple

11496	€ 9,00
-------	--------

Doppelring / double ring / aro sencillo / cercle double

11497	€ 16,00
-------	---------



0,5 ltr.

Schale

bowl
cuenco
bol



	Ø cm	↑ cm	ltr.	€
11865	14	3,5	0,5	2,20



Schutzdeckel mit Löffelaussparung

cover
tapa
couvercle



	Ø cm	€
11868	14,5	10,40

Buffet & Display



Buffetständer „BIG“

buffet stand
expositor de bufé
présentoir buffet



7-teiliges Set: 3 Glasschalen Ø 23 cm 2,5 Liter, 3 klappbare Schutzdeckel, 1 Ständer

7 pcs. set: 3 glass bowls Ø 23 cm 2.5 litres, 3 hinged covers, 1 stand

7 piezas: 3 boles vidrio Ø 23 cm, 2,5 l, 3 tapas con bisagra, 1 soporte

7 éléments: 3 bols verre Ø 23 cm 2,5 l, 3 couvercles à charnière, 1 support

	cm	↑ cm	€
11892	50 x 50	18	114,00



Schale „CASUAL MAXI“

bowl
cuenco
bol



	Ø cm	↑ cm	ltr.	Farbe / Colour	€
83702	23	10,5	2,50	White	9,00
83703	23	10,5	2,50	Black	9,00



Buffetständer „LITTLE“

buffet stand
expositor de bufé
présentoir buffet



7-teiliges Set: 3 Glasschalen Ø 14 cm 0,5 Liter, 3 klappbare Schutzdeckel, 1 Ständer

7 pcs. set: 3 glass bowls Ø 14 cm 0,5 l, 3 hinged covers, 1 stand

7 piezas: 3 boles vidrio Ø 14 cm, 0,5 l, 3 tapas con bisagra, 1 soporte

7 éléments: 3 bols verre Ø 14 cm 0,5 l, 3 couvercles à charnière, 1 support

	cm	↑ cm	€
11893	30 x 30	14	84,00



Schale „CASUAL MAXI“

bowl
cuenco
bol



	Ø cm	↑ cm	ltr.	Farbe / Colour	€
83700	14	6,5	0,50	White	3,80
83701	14	6,5	0,50	Black	3,80



Besteckständer „TRIPLE TOWER“

cutlery basket
cesta para cubiertos
égouttoir à couverts



4-teiliges Set: 1 Gestell + 3 Köcher

4 pcs. set: 1 frame + 3 baskets

set de 4 piezas: 1 estructura + 3 cubiertos

set de 4 éléments: 1 structure + 3 corbeille

	cm	↑ cm	Farbe / Colour	€
11466	18 x 26	43	White	79,00
11467	18 x 26	43	Black	79,00



variable Nutzungsmöglichkeiten
variable usage possibilities



Vitrine / Thekenaufsatz

showcase
vitrina de mostrador
vitrine de comptoir



rutschfest, aus einem Teil gefertigt
antislip, monoblock produced
plástico transparente, fabricado en 1 pieza
transparente, plastique monoblock (injecté)

	cm	↑ cm	€
11888	63,5 x 25	25	82,00



Snackpresenter

snackpresenter
dispensador de bocadillos
présentoir à sandwiches



mit Safrille und Griffmulde, passend für Vitrine 11888
with recessed grip, suitable for showcase 11888
asa moldeada, apto para la vitrina 11888
anse moulée, apte pour vitrine 11888

	cm	↑ cm	€
11887	29 x 19	6,5	19,40
11889	60 x 19	7,5	24,00

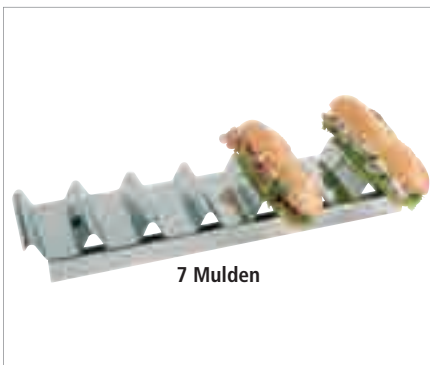

Snackpresenter

snackpresenter
dispensador de bocadillos
présentoir à sandwiches



hochglanzpoliert, mit Griffmulde, für 7 Baguettes
mirror polished finish, with recessed grip, for 7 baguettes
inox pulido brillante, ideal para hasta 7 bocadillos
inox poli brillant, parfait jusque maxi 7 sandwiches

	cm	↑ cm	€
11891	47,5 x 10,5	6	25,00

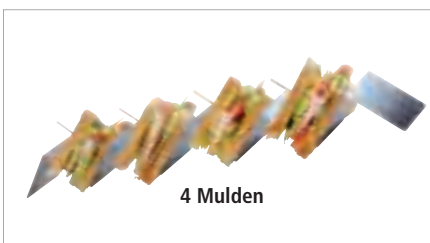

Snackpresenter

snackpresenter
dispensador de bocadillos
présentoir à sandwiches



	cm	↑ cm	€
11969	56 x 8	5,5	12,00

Brotstation

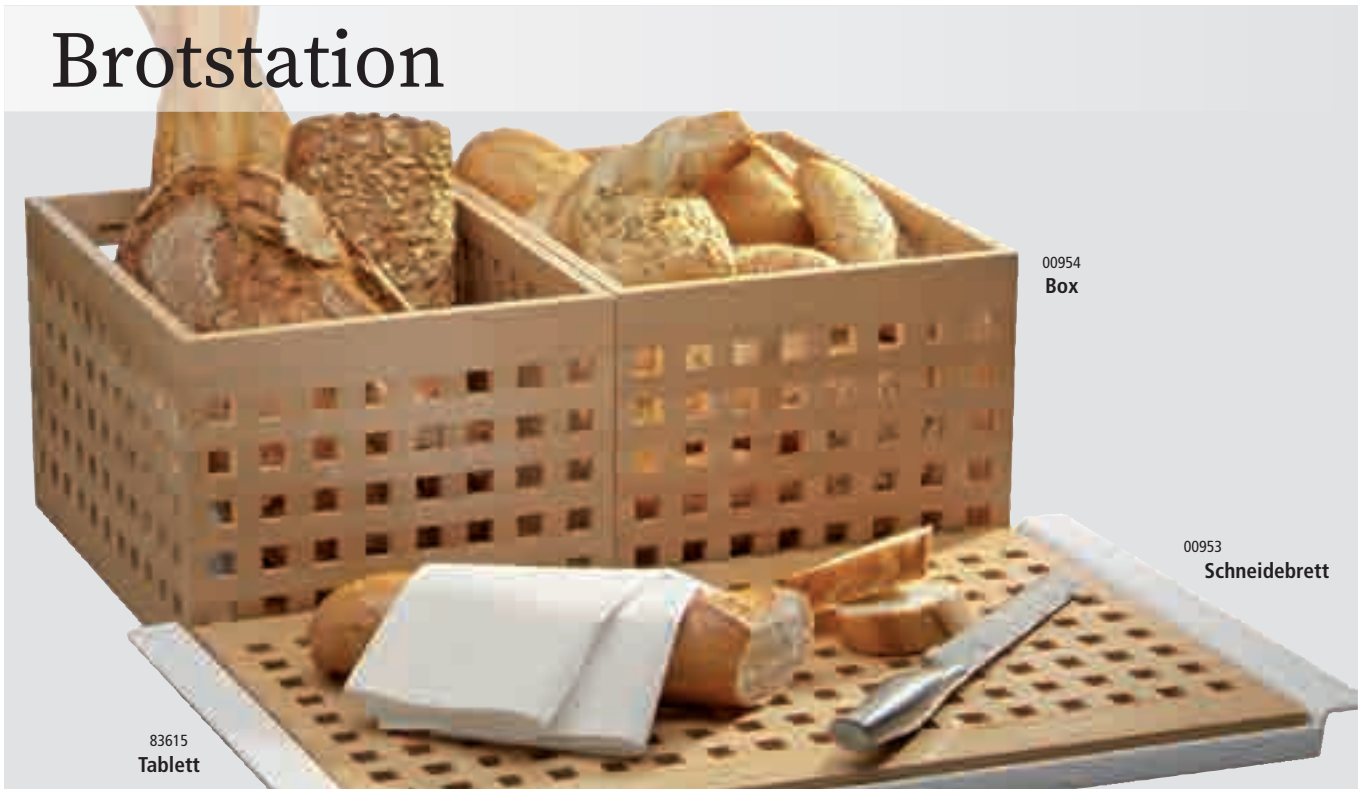

00954
Box

00953
Schneidebrett

83615
Tablett



Tablett „BROTSTATION“

tray
bandeja
plateau



Antirutsch-Füßchen
non-slip feet
pies antideslizantes
pieds antiglisse

	cm	↑ cm	€
83615	59,5 x 35,5	3,5	37,00



00953
Schneidebrett

83615
Tablett

Brotschneidebrett „BROTSTATION“

cutting board
tabla de corte
planche à découper



Buchen-Holz
beech
haya
hêtre

	cm	↑ cm	€
00953	52 x 34	2	33,00



00954
Box

00959
Box

83615
Tablett

Box „BROTSTATION“

box
caja de pan para el bufé
boîte à pain pour le buffet



Buchen-Holz
beech
haya
hêtre

	cm	↑ cm	€
00959	34 x 26	12,5	50,00
00954	34 x 26	20,0	56,00



Brotschneidebrett „LETTER“

cutting board
 tabla para cortar
 planche à découper



mit herausnehmbarem Krümfach, auf 4 Antirutschfüßchen,
 mit internationaler Aufschrift auf 2 Seiten

with bread crump shelf, with 4 non-slip-feet, with international inscription on 2 sides
 con bandeja para migas, 4 pies antideslizantes, inscripción internacional en 2 lados
 avec plat ramasse-miettes, 4 pieds antidérapants et inscription internationale sur 2 côtés

	cm	↑ cm		€
00886	48 x 34	3,5		32,00



Brotschneidebrett „AKAZIA“

cutting board
 tabla para cortar
 planche à découper



mit herausnehmbarem Krümfach, auf 4 Antirutschfüßchen, Akazienholz

with bread crump shelf, anti slip-feet, wood akazia
 tabla para cortar pan, madera tratada antideslizante
 planche à pain, bois traité antidérapant

	cm	↑ cm	GN	€
00883	47,5 x 32,0	2		25,80
00884	53,0 x 32,5	2	1/1	26,40
00885	60,0 x 40,0	2		32,00



praktisches Krümfach
 praktisches Krümfach



Brotschneidebrett „RUBBERWOOD“

cutting board
 tabla para cortar
 planche à découper



mit herausnehmbarem Krümfach, auf 4 Antirutschfüßchen

with bread crump shelf, anti slip-feet
 tabla para cortar pan, madera tratada antideslizante
 planche à pain, bois traité antidérapant

	cm	↑ cm	GN	€
00955	47,5 x 32,0	2		24,00
00956	53,0 x 32,5	2	1/1	25,00
00957	60,0 x 40,0	2		29,00



Brotschneidebrett, 2-tlg.

cutting board, 2 pcs.
 tabla para cortar, 2 piezas
 planche à découper, 2 pièces



2-tlg. Set, GN 1/1 Behälter, 20 mm tief, dient als Krümfach

2 pcs. set, GN 1/1 pan 20 mm, bread crump shelf
 set de 2 piezas: tabla de corte + bandeja inox GN 1/1 alt 20 mm (sirve para recoger las migas)
 set de 2 pièces: planche à découper bois + plateau inox GN 1/1 Ht 20 mm (sert de ramasse-miettes)

	cm	GN	€
00951	53 x 32,5	1/1	33,00

einzelnes Brett / separate board / tabla por separado / planche seule

	cm	GN	€
00952	53 x 32,5	1/1	17,00



Cerealienspender

cereal dispenser
dispensador de cereales
distributeur de céréales



Behälter herausnehmbar, portionieren durch einfaches Drehen
removable canister, easy to use, rotate the button to get the muesli
contenedor movable, fácil de usar, se gira el pomo para servir los cereales
réceptif amovible, usage facile en tournant le bouton

	cm	↑ cm	ltr.	Farbe / Colour	€
12050	24,0 x 17,5	49,5	4,5	White	59,00
12051	24,0 x 17,5	49,5	4,5	Black	59,00



Cerealienspender „DUO“

cereal dispenser
dispensador de cereales
distributeur de céréales



Behälter herausnehmbar, portionieren durch einfaches Drehen
removable canister, easy to use, rotate the button to get the muesli
contenedor movable, fácil de usar, se gira el pomo para servir los cereales
réceptif amovible, usage facile en tournant le bouton

	cm	↑ cm	ltr.	Farbe / Colour	€
12054	24,0 x 37,5	49,5	2 x 4,5	White	109,00
12055	24,0 x 37,5	49,5	2 x 4,5	Black	109,00





Buffetständer „GOOD MORNING“

buffet stand
expositor de bufé
présentoir à céréales



4-teiliges Set: Holzständer inkl. 3 Gläser mit luftdichtem Klappdeckel

4 pcs. set: wood stand included 3 glass with airtight cover

4 pz: soporte, 3 boles de cristal, cierre hermético

4 pc. présentoir, 3 bols en verre, fermeture hermétique

	cm	Farbe / Colour	€
13965	43 x 17		82,00
14965	43 x 17		82,00

Glas mit luftdichtem Klappdeckel / glass with airtight cover / cristal, cierre hermético / verre, fermeture hermétique

	cm	↑ cm	ltr.	€
82328	12 x 12	22	2	6,20



Cerealienspender „FRESH & EASY“

cereal dispenser
dispensador de cereales
distributeur de céréales



Behälter herausnehmbar, „Feierabend-Deckel“ für das aromadichte Lagern, portionieren durch einfaches Drehen

removable canister, special lid to keep the cereals fresh, easy to use, rotate the button to get the muesli

contenedor movable, tapa especial para mantener los cereales frescos, fácil de usar, se gira el pomo para servir los cereales

réceptif amovible, couvercle spécial pour conserver les céréales, usage facile en tournant le bouton

	cm	↑ cm	ltr.	€
11805	22 x 17,5	52	4,5	66,00



Cerealienspender Duo „FRESH & EASY“

cereal dispenser
dispensador de cereales
distributeur de céréales



Behälter herausnehmbar, „Feierabend-Deckel“ für das aromadichte Lagern, portionieren durch einfaches Drehen

removable canister, special lid to keep the cereals fresh, easy to use, rotate the button to get the muesli

contenedor movable, tapa especial para mantener los cereales frescos, fácil de usar, se gira el pomo para servir los cereales

réceptif amovible, couvercle spécial pour conserver les céréales, usage facile en tournant le bouton

	cm	↑ cm	ltr.	€
11807	22 x 35	52	2 x 4,5	122,00

Kunststoffbehälter / canister / contenedor / réceptif

	Ø cm	ltr.	€
11808	24	4,5	24,00



Cerealienspender „CLASSIC“

cereal dispenser
dispensador de cereales
distributeur de céréales



Portionieren durch einfaches Drehen, Behälter herausnehmbar

canister removable

contenedor movable

réceptif amovible

	cm	↑ cm	ltr.	€
11833	35 x 26,5	68	8	184,00

Buffet & Display



2 x 8 ltr.

Cerealispender „CLASSIC DUO“

cereal dispenser
dispensador de cereales
distributeur de céréales



Portionieren durch einfaches Drehen, Behälter herausnehmbar

canister removable
contenedor movable
réceptient amovible

	cm	↑ cm	ltr.	€
11834	35 x 50	68	2 x 8	334,00



13987

14987

Cerealispender „BRIDGE“

cereal dispenser
dispensador de cereales
distributeur de céréales



Behälter herausnehmbar, „Feierabend-Deckel“ für das aromadichte Lagern, portionieren durch einfaches Drehen

removable canister, special lid to keep the cereals fresh, easy to use, rotate the button to get the muesli

contenedor movable, tapa especial para mantener los cereales frescos, fácil de usar, se gira el pomo para servir los cereales

réceptient amovible, couvercle spécial pour conserver les céréales, usage facile en tournant le bouton

	cm	↑ cm	ltr.	Farbe / Colour	€
13987	21 x 20	55,5	4,5	Ahorn	102,00
14987	21 x 20	55,5	4,5	Wenge	102,00



Cerealispender „ROTATION“

cereal dispenser
dispensador de cereales
distributeur de céréales



matt poliert, drehbarer massiver Ständer, Behälter herausnehmbar, inkl. Frischhaltedeckel

satin polished finish, rotating food, canister removable, incl. airtight covers

pulido acabado satinado, giratorio, incluye tapas herméticas

mat satiné, rotatif, inclut couvercles hermétiques

	Ø cm	↑ cm	ltr.	€
11970	38	54	3 x 4,5	310,00

Kunststoffbehälter / canister / contenedor / réceptient

11808				24,00
-------	--	--	--	-------



Cerealispender „ROTATION“

cereal dispenser
dispensador de cereales
distributeur de céréales



Buchen-Holz versiegelt, drehbarer massiver Ständer, Behälter herausnehmbar, inkl. Frischhaltedeckel

wood beech covered waterproof, rotating foot, canister removable, incl. airtight cover

tapa en madera de haya resistente al agua, pie giratorio, recipiente removable, incluye tapa hermética

couvercle en hêtre traitée contre l'humidité, pied rotatif, récipients démontables, inclut couvercles hermétiques

	Ø cm	↑ cm	ltr.	€
11975	38	54	3 x 4,5	314,00

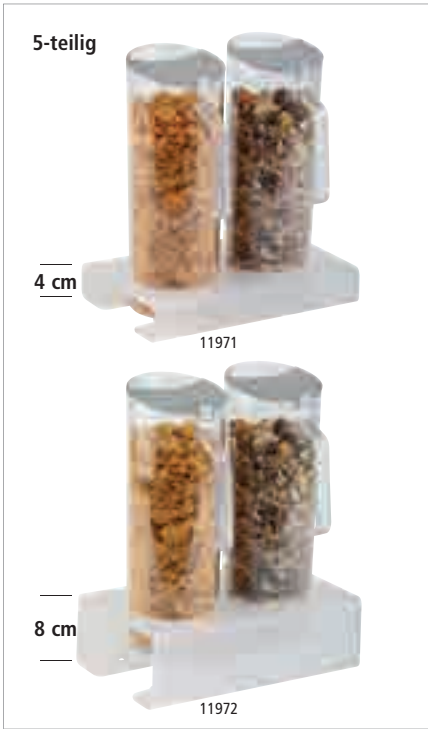

Cerealien-Bar

cereal-bar
barra para dispensador de cereales
bar à céréales



5-teiliges Set, mit Ständerhöhe 4 oder 8 cm: 1 Ständer aus Acryl gefrostet und rutschfest + 2 Karaffen mit schwenkbarem Edelstahl-Deckel + 2 luftdichte Frischhaltedeckel

5 pcs. set, with stand heights 4 or 8 cm: 1 stand acryl frosted and anti-slip + 2 pitchers with stainless steel flap lid + 2 airtight covers

set 5 piezas con stands a diferentes alturas, 4 u 8 cm: 1 stand acryl + 2 jarras con tapa de solapa de acero inoxidable + 2 tapas herméticas adicionales

set 5 éléments avec supports à différentes hauteurs: 4 ou 8 cm - 1 support acrylique satiné antiglisse + 2 pichets à céréales avec couvercle à charnière inox + 2 couvercles hermétiques

	cm	↑ cm	ltr.	€
11971	26 x 17	28,5	2 x 1,5	64,00
11972	26 x 17	32,5	2 x 1,5	89,00



ideal für Stufenpräsentation
best for staged presentations

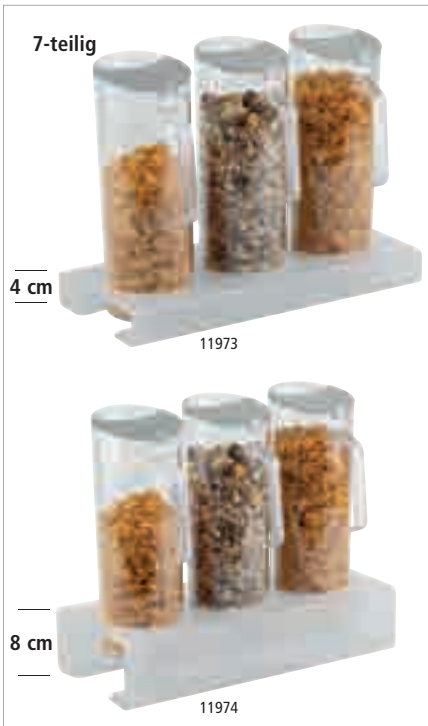

Cerealien-Bar

cereal-bar
barra para dispensador de cereales
bar à céréales



7-teiliges Set, mit Ständerhöhe 4 oder 8 cm: 1 Ständer aus Acryl gefrostet und rutschfest + 3 Karaffen mit schwenkbarem Edelstahl-Deckel + 3 luftdichte Frischhaltedeckel

7 pcs. set, with stand heights 4 or 8 cm: 1 stand acryl frosted and anti-slip + 3 pitchers with stainless steel flap lid + 3 airtight covers

set 7 piezas con stands a diferentes alturas, 4 u 8 cm: 1 stand acryl + 3 jarras con tapa de solapa de acero inoxidable + 3 tapas herméticas adicionales

set 7 éléments avec supports à différentes hauteurs: 4 ou 8 cm - 1 support acrylique satiné antiglisse + 3 pichets à céréales avec couvercle à charnière inox + 3 couvercles hermétiques

	cm	↑ cm	ltr.	€
11973	38 x 17	28,5	3 x 1,5	89,00
11974	38 x 17	32,5	3 x 1,5	114,00



ideal für Stufenpräsentation
best for staged presentations



Cerealienkaraffe

cereal pitcher
jarra de cereales
pichet à céréales



schwenkbarer Edelstahl-Deckel, inkl. luftdichtem Frischhaltedeckel

stainless steel flap lid, incl. 1 airtight cover

tapa de solapa de acero inoxidable, incluye otra tapa hermética

couvercle à charnière inox + couvercle hermétique

	Ø cm	↑ cm	ltr.	€
10778	10	28	1,5	20,00

Frishhaltedeckel / conservation lid / tapa de conservación / couvercle

10668				2,40
-------	--	--	--	------

SERVICE TOWER



Service Tower

service tower
service tower
tour de service



Präsentations- und Spendersystem, bei minimalen Platzbedarf, optimale Wertschöpfung, zum Beispiel im Bereich der Besteckausgabe, Kaffeestationen, Speiseausgaben, Verkaufstheken, etc., Rückwand aus dunklem Holz oder Acryl gefrostet

Presentation and dispenser system, the products find their best creation of value at minimal need of space, for example in the range of coffeestations, food service, counters etc., backplane made of dark wood or acrylic frosted

sistema de presentación y dispensador, con el mínimo espacio conseguirá una excelente presentación de sus productos, por ejemplo en la zona del café, comidas, etc., trasera de madera oscura o de acrílico opaco mate

système de présentation et distribution, très élégant dans un espace minimum, idéal pour la zone café, coin repas, etc., paroi en bois foncé ou en acrylique mat

	cm	↑ cm	Farbe / Colour		€
11431	26 x 18	43	■	2x Schütte, tief + 1x Schütte, flach 2 deep ones + 1 flat one 2 rampas hondas + 1 plana / 2 rampas profundes + 1 plates	94,00
11432	26 x 18	43	■	3x Schütte, tief / 3 bowls, deep ones 3 rampas hondas / 3 rampas profundes	94,00
11422	26 x 18	57,5	■	4x Schütte, tief / 4 bowls, deep ones 4 rampas hondas / 4 rampas profundes	114,00

	cm	↑ cm	Farbe / Colour		€
11433	26 x 18	43	■	2x Schütte, tief + 1x Schütte, flach / 2 deep ones + 1 flat one / 2 rampas hondas + 1 plana / 2 rampas profundes + 1 plate	94,00
11434	26 x 18	43	■	3x Schütte, tief / 3 bowls, deep ones 3 rampas hondas / 3 rampas profundes	94,00
11424	26 x 18	57,5	■	4x Schütte, tief / 4 bowls, deep ones 4 rampas hondas / 4 rampas profundes	114,00



Basisfuss / base / pie de la base / pied de la base

	€
11435	41,00

Rückwand Holz / backplane made of wood / trasera de madera / arrière bois

	cm		€
11436	44,5 x 24	für 3 Schütten	33,50
11426	60 x 24	für 4 Schütten	47,50

Rückwand Acryl / backplane made of acrylic / trasera acrílica / arrière acrylique

	cm		€
11437	44,5 x 24	für 3 Schütten	33,50
11427	60 x 24	für 4 Schütten	47,50

Schütte, tief / bowl, deep / rampa, honda / rampe profonde

	cm	↑ cm	€
11438	22 x 14	7 / 5	6,30

Schütte, flach / bowl / rampa plana / rampe plate

	cm	↑ cm	€
11439	22 x 13	3 / 1	6,30

MULTI RACK



Multi Rack
multi rack
dispensador en escalera
support multiple



2-stufig, 3-teilig: 1 Gestell matt poliert + 2 Schütten aus transparent gefroretetem Kunststoff, je ca. 1 Liter

2-tier, 3 pcs. set: 1 frame satin polished finish + 2 bowls frosted plastic, approx. 1 liter
2 alturas - set de 3 pz: 1 soporte inox mate satinado + 2 bols plástico glaseado, aprox. 1 litro
2 niveaux - set de 3 éléments: 1 support satiné + 2 bols plastique mat, approx. 1 litre

	cm	↑ cm	€
11442	19 x 24	28	36,60



Multi Rack
multi rack
dispensador en escalera
support multiple



3-stufig, 4-teilig: 1 Gestell matt poliert + 3 Schütten aus transparent gefroretetem Kunststoff, je ca. 1 Liter

3-tier, 4 pcs. set: 1 frame satin polished finish + 3 bowls frosted plastic, approx. 1 liter
3 alturas, set de 4 piezas: 1 estructura inox satinado + 3 bols de plástico glaseado, aprox. 1 litro
3 niveaux - set de 4 éléments: 1 structure inox poli satin, + 3 bols plastique mat, approx. 1 litre

	cm	↑ cm	€
11444	19 x 24	41	42,90



Multi Rack
multi rack
dispensador en escalera
support multiple



3-stufig, 4-teilig: 1 Gestell matt poliert + 1 Schütte aus transparent gefroretetem Kunststoff, ca. 1 Liter + 2 Rutschen aus transparent gefroretetem Kunststoff

3-tier, 4 pcs. set: 1 frame satin polished finish + 1 bowl frosted plastic, approx. 1 liter + 2 slides frosted plastic
3 alturas, set de 4 piezas, 1 soporte inox satinado + 1 bol de plástico glaseado, aprox, 1 litro + 2 bols con „tobogán“ en plástico glaseado
3 niveaux - set de 4 éléments: 1 structure inox poli satin + 1 bol plastique mat approx. 1 litre + 2 bols avec „toboggan“

	cm	↑ cm	€
11449	19 x 24	41	42,90



Multi Rack
multi rack
dispensador en escalera
support multiple



4-stufig, 5-teilig: 1 Gestell matt poliert + 4 Schütten aus transparent gefroretetem Kunststoff, je ca. 1 Liter

4-tier, 5 pcs. set: 1 frame satin polished finish + 4 bowls frosted plastic, approx. 1 liter
4 alturas, set de 5 piezas: 1 estructura inox satinado + 4 bols de plástico glaseado, aprox. 1 litro
4 niveaux - set de 5 éléments: 1 structure inox poli satin, 4 bols plastique mat, approx. 1 litre

	cm	↑ cm	€
11446	19 x 31	53	54,00

Buffet & Display



Multi Rack

multi rack
dispensador en escalera
support multiple



4-stufig, 5-teilig: 1 Gestell matt poliert + 3 Schütten aus transparent gefroretetem Kunststoff, je ca. 1 Liter + 1 Rutsche aus transparent gefroretetem Kunststoff

4-tier, 5 pcs. set: 1 frame satin polished finish + 3 bowls frosted plastic, approx. 1 liter + 1 slide frosted plastic

4 alturas, set de 5 piezas: 1 estructura inox satinado + 3 bols de plástico glaseado, aprox. 1 litro + 1 bol con „tobogán“ de plástico efecto glaseado

4 niveaux - set de 5 éléments: 1 structure inox poli satin + 3 bols plastique mat approx. 1 litre + 1 bol avec „toboggan“

	cm	↑ cm	€
11451	19 x 31	53	54,00



Schütte

Ergänzung für alle Multi-Racks

supplement for all multi racks
suplemento para todos los dispensadores
compléments pour support Multi-Rack



	€
11455 Schütte / canister / bol / bol	6,50



Rutsche

Ergänzung für alle Multi-Racks

supplement for all multi racks
suplemento para todos los dispensadores
compléments pour support Multi-Rack



	€
11456 Rutsche / slide / tobogan / toboggan	6,50

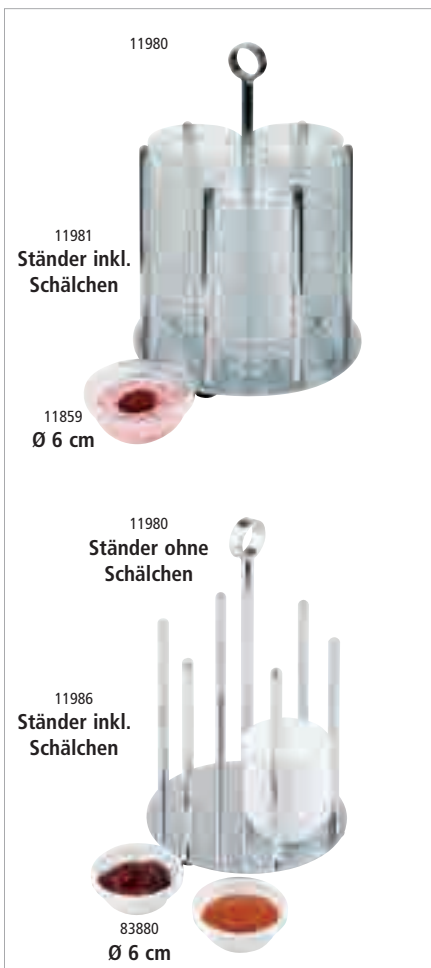

11980

11981
Ständer inkl.
Schälchen

11859
Ø 6 cm

11980
Ständer ohne
Schälchen

11986
Ständer inkl.
Schälchen

83880
Ø 6 cm

Schälchenspender „MINI“

bowl holder
rack dispensador para bols
porte-bols



geeignet für Schalen Ø 6 cm, bestückbar mit bis zu 36 Schalen

for bowls Ø 6 cm, suitable for 36 bowls

para bols de Ø 6 cm, apto para 36 bols

pour bols de Ø 6 cm, maxi 36 bols

	Ø cm	↑ cm	€	
11981	14	25,5	Ständer inkl. 36 Glasschalen, Ø 6 cm / frame with 36 bowls, Ø 6 cm soporte con 36 bols, Ø 6 cm / support livré avec 36 bols en verre Ø 6 cm	91,00
11986	14	25,5	Ständer inkl. 36 Melaminschalen, Ø 6 cm / frame with 36 melamine bowls, Ø 6 cm soporte con 36 bols de melamina Ø 6 cm / support avec 36 bols en mélamine Ø 6 cm	84,00

Schälchenspender „MINI“ / bowl holder / rack dispensador para bols / porte-bols

	Ø cm	↑ cm	€	
11980	14	25,5	Ständer ohne Schalen / frame without bowls soporte sin bols / support sans bols	45,00

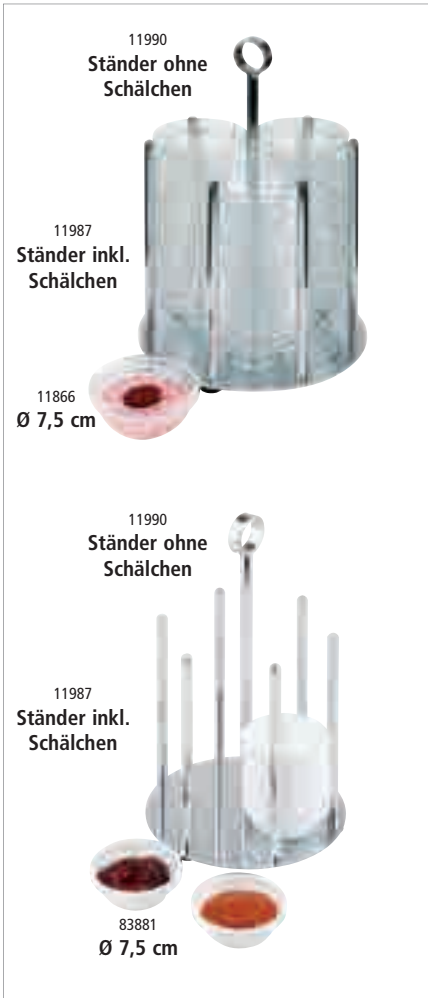

Schälchenspender „MEDIUM“

bowl holder
rack dispensador para bols
porte-bols



geeignet für Schalen Ø 7,5 cm, bestückbar mit bis zu 36 Schalen
for bowls Ø 7,5 cm, suitable for 36 bowls
para bols de Ø 7,5 cm, apto para 36 bols
pour bols de Ø 7,5 cm, maxi 36 bols

	Ø cm	↑ cm		€
11991	17,5	25,5	Ständer inkl. 36 Glasschalen, Ø 7,5 cm / frame with 36 bowls, Ø 7,5 cm soporte con 36 bols, Ø 7,5 cm / support livré avec 36 bols en verre Ø 7,5 cm	92,00
11987	17,5	22,5	Ständer inkl. 36 Melaminschalen, Ø 7,5 cm / frame with 36 melamine bowls, Ø 7,5 cm soporte con 36 bols de melamina, Ø 7,5 cm / support avec 36 bols en mélamine Ø 7,5 cm	99,00

Schälchenspender „MEDIUM“ / bowl holder / rack dispensador para bols / porte-bols

	Ø cm	↑ cm		€
11990	17,5	25,5	Ständer ohne Schalen / frame without bowls soporte sin bols / support sans bols	46,00



Schälchen „CASUAL MINI“

bowl
cuenco
bol mini



	Ø cm	↑ cm	ltr.	€
83880	6,0	2,5	0,02	1,60
83881	7,5	3,5	0,05	2,00



Schale

bowl
cuenco
bol



	Ø cm	↑ cm	ltr.	€
11859	6,0	2,5	0,05	1,30
11866	7,5	6,5	0,09	1,40

Buffet & Display



Vorratsglas „WOODY“

canister with lid
bote con tapa
pot en verre avec couvercle



Holzdeckel mit Silikondichtung
wooden lid with silicone gasket



Glasbehälter mit Holzdeckel, aromadichter Verschluss

glass container, aroma-tight screw cap
recipiente de cristal, tapa con cierre hermético para conservar el aroma
récipient en verre, couvercle avec fermeture hermétique pour conserver l'arôme

	Ø cm	→ cm	ltr.	€
82255	14 x 14	11,0	1,0	7,80
82256	14 x 14	17,0	2,0	8,20
82257	14 x 14	21,5	2,5	8,90



Vorratsglas „CLASSIC“

canister with lid
bote con tapa
pot en verre avec couvercle



inkl. Glasdeckel mit Dichtung. Somit bleibt Ihre Ware frisch
incl. glass lid with seal. Thus, your goods remain fresh
incl. tapa de vidrio con junta. Por lo tanto, sus productos permanecen frescos
y compris couvercle en verre avec joint. Ainsi, vos marchandises restent fraîches

	Ø cm	↑ cm	ltr.	€
82250	11,5	16,0	0,9	4,90
82251	14,0	21,5	2,0	8,90
82252	18,0	26,0	4,0	14,00
82253	20,0	30,0	6,0	16,40



Vorratsglas mit luftdichtem Klappdeckel

glass with airtight cover
bote con cierre hermético
pot en verre avec fermeture hermétique



	cm	↑ cm	ltr.	€
82328	12 x 12	22	2	6,20



Vorratsglas

canister with lid
bote con tapa
pot en verre avec couvercle



Glaskugel mit Löffel, Schraubdeckel mit aromadichtem Verschluss, Edelstahl-Löffel mit magnetischem Silikongriff, 1 Stck.
tight cover, stainless steel spoon with magnetic silicone handle, 1 pc.
tapa a rosca con cierre hermético, cuchara de acero inoxidable con mango de silicona magnético, 1 pza
couvercle à vis avec fermeture hermétique, cuillère en acier inox avec manche de silicone aimanté, 1 pc.

	Ø cm	↑ cm	ltr.	€
00636	20	18	3	9,80



Vorratsglas

canister with lid
bote con tapa
pot en verre avec couvercle



Glaskugel mit Schraubdeckel, aromadichtem Verschluss, 1 Stck.
glass ball, aroma-tight screw cap, 1 pc.
bote de cristal, tapa a rosca para conservar el aroma, 1 pza
pot en verre, couvercle à vis pour conserver l'arôme, 1 pc.

	cm	↑ cm	ltr.	€
00637	12,5 x 19	18	1	7,20

Buffet & Display



stapelbar

↑ Front-klappe

11884

11885

Universalbox

box / sweetbox
caja dispensadora
boîte distributrice



ideal als Verkaufsbox, mit Frontdeckel

best to present sweets etc., all-purpose, with front lid

la perfecta solución para presentar golosinas, universal, con tapa frontal

la solution idéale pour les friandises et autres, universel, avec couvercle frontal

	cm	↑ cm	Farbe / Colour	€
11884	23 x 14,5	15		11,00
11885	23 x 14,5	15		11,00



Universalbox

universal box
caja dispensadora
boît distributrice



ideal für Zucker, Milch und Gebäck, 3 Fächer

best for sugar, milk and biscuits, 3 compartments

la perfecta solución para sucre, leche y galletas, 3 compartimentos

la solution idéale pour sucre, lait et biscuits, 3 compartiments

	cm	↑ cm	€
11886	41,5 x 20,5	16	29,00



Brötchenspender

roll dispenser
dispensador de panecillos
distributeur de petits pains



hygienisch und einfach zu reinigen, mit Krümelschale

hygienic and easy to clean, with crumb tray

higiénico y fácil de limpiar, con bandeja para migas

hygiénique et facile à laver, avec plat ramasse-miettes

	cm	↑ cm		€
11572	32,5 x 27,5	42	für ca. 45 - 50 Brötchen / for approx. 45 - 50 rolls para 45-50 panecillos / pour 45-50 petits pains	194,00
11573	32,5 x 27,5	56	für ca. 65 - 70 Brötchen / for approx. 65 - 70 rolls para 65-70 panecillos / pour 65-70 petits pains	219,00

Deckel / Cover / tapa / couvercle seul

	cm	↑ cm	€
11562	33,5 x 21,5	4	18,40



Hygieneschutz

hygienic cover
cubierta higiénica antialiento
pare-haleine



	cm	↑ cm	€
11556	82 x 42	45	184,00



Teebox / Multibox
tea caddy
caja para té
boîte à thé et infusions



3 Fächer für kuvertierte Teebeutel, 1 Fach für Zucker, Kekse, etc., Deckel aufklappbar
4 chambers
4 compartimentos
4 compartiments

	cm	↑ cm	€
11563	22 x 17	9	17,00



Teebox
tea-box
caja para té
boîte à thé et infusions



Holzbox mit Sichtfenster, mit Aufschrift „Tee“, 4 Kammern können mit je 30 kuvertierten Teebeuteln bestückt werden, Deckel bleibt offen stehen

wooden box with clear transparent window, with inscription „Tee“, 4 chambers for approx. 30 tea bags

caja de madera clara con ventana transparente, con inscripción „Tee“, 4 compartimentos, para aproximadamente 30 bolsas de té

en bois clair avec fenêtre, marquée „TEE“, 4 compartiments, pour environ 30 sachets

11575

	cm	↑ cm	Farbe / Colour	€
11575	33,5 x 20	9		17,00
11574	33,5 x 20	9		17,00

11574

	cm	↑ cm	Farbe / Colour	€
11576	33,5 x 20	9	ohne Aufschrift / without inscription sin inscripción / sans inscription	17,00



Teebox
tea-box
caja para té
boîte à thé et infusions



Holzbox mit Sichtfenster, mit Aufschrift „Tee“, 12 Kammern können mit je 12 kuvertierten Teebeuteln bestückt werden, Deckel bleibt offen stehen

wooden box with clear transparent window, with inscription „Tee“, 12 chambers for approx. 144 tea bags

caja de madera clara con ventana transparente, con inscripción „Tee“, 12 compartimentos, para aproximadamente 144 bolsas de té

en bois clair avec fenêtre, marquée „TEE“, 12 compartiments, pour environ 144 sachets

11775

	cm	↑ cm	Farbe / Colour	€
11775	31 x 28	9		23,00
11776	31 x 28	9		23,00

11776

Buffet & Display



GN 1/1 Besteckbehälter

GN 1/1 dispenser GN
GN 1/1 dispensador de cubiertos
GN 1/1 bac à couverts



in Handarbeit geflochten, 4 Mulden, Kunststoff-Geflecht, Drahtgestell, braun-schwarz

wickerwork, 4 compartments, with reinforced chromed wire structure, brown-black

cesta trensada a mano, 4 compartimentos, de plástico, con bastidor cromado reforzado, marrón oscuro

corbeille tressée à main, 4 compartiments, en plastique, cadre acier chromé renforcé, couleur marron foncé

	cm	↑ cm	Farbe / Colour	€
11966	53 x 32,5	9		33,00



GN 1/1 Besteckbehälter „BUFFET“

GN 1/1 cutlery dispenser
GN 1/1 dispensador de cubiertos
GN 1/1 bac à couverts



4 Mulden, Kunststoff-Geflecht, Drahtgestell, beige

4 troughs, wickerwork, wire, beige

4 huecos, trabajo de cestería

4 compartiments, plastique tressé, cadre acier chromé renforcé, couleur osier naturel

	cm	↑ cm	Farbe / Colour	€
11965	53 x 32,5	10		24,00



GN 1/1 Besteckbehälter

GN 1/1 cutlery tray / box stand
GN 1/1 dispensador de cubiertos
GN 1/1 bac à couverts



	cm	↑ cm	Farbe / Colour	€
11955	53 x 32,5	10		6,00



GN 1/1 Besteckkasten

cutlery box GN 1/1
GN 1/1 dispensador de cubiertos
GN 1/1 bac à couverts



	cm	↑ cm	Farbe / Colour	€
11960	53 x 32,5	10		6,60





Besteckbehälter „ELEMENT“

cutlery bin
recipiente para cubiertos
récipients pour couverts

mit Abflussloch, mit Besteck Logo, Bodeneinlagen aus Silikon zum Schonen der Messerspitzen, möbelschonende Unterseite
with drain hole, with cutlery logo, silicone floor inserts for saving the points of knives, with non-scratching undersurface
con orificio de drenaje, con logotipo de cubertería, soporte de silicona para proteger las puntas de los cuchillos, con base antirrayaduras
avec le trou de drainage, avec le logo de coutellerie, insert de silicone pour protéger les pointes des couteaux, avec base revêtue antirayures



	Ø cm	↑ cm	€
00018	11	14	14,50



Besteckköcher

cutlery basket
cesta para cubiertos
corbeille à couverts



	Ø cm	↑ cm		€
11998	9,7	13,7	Kunststoff weiß / white plastic plástico blanco / plastique blanc	2,50
11999	9,7	13,7	matt poliert / satin polished finish acero inoxidable / inox	7,90

11998
Köcher weiß
PE white

11999
Köcher Edelstahl
stainless steel



Besteckbehälter

cutlery basket
dispensador de cubiertos
présentoir à couverts

matt poliert
satin polished finish
inox mate (sin cubiertos)
inox mat



	cm	↑ cm		€
11994	26,0 x 30 Ø 10	20	4 Löcher inkl. Köcher (Kunststoff) 4 holes incl. dispensers (plastic) 4 agujeros incl. dispensador plástico 4 places, avec 4 récipients (plastique)	62,00
11997	37,5 x 30 Ø 10	20	6 Löcher ohne Köcher 6 holes without dispensers 6 agujeros sin dispensador de plástico 6 places, sans récipients	77,00

11994

11997



Besteckbehälter

cutlery basket
recipiente para cubiertos
récipients pour couverts

4 Löcher inkl. 4 Edelstahl Köcher
4 holes incl. 4 stainless baskets
4 agujeros, incl. 4 cestas de acero
4 places, avec 4 corbeille inox



	cm	↑ cm	Farbe / Colour	€
93321	27 x 27	15	■	69,00



Tischrestebehälter „SUNDAY“

table waste bin
papelera de sobremesa
poubelle de table



matt poliert, inkl. Deckel, fester Deckelsitz
satin polished finish, incl. cover, cover removeable
acero inoxidable mate, con tapa
inox mat, avec couvercle

	Ø cm	↑ cm	ltr.	€
00024	10	18	1,1	23,90



Tischrestebehälter

table garbage bin
papelera de sobremesa
poubelle de table



Behälter aus weiß lackiertem Metall, Edelstahl-Lochdeckel
metall white, stainless cover with hole
tapa, acero inoxidable, con apertura
couvercle inox, avec ouverture centrale, récipient en acier laqué blanc

	Ø cm	↑ cm	ltr.	€
00292	12	15	1,2	14,00



Tischrestebehälter

table garbage bin
papelera de sobremesa
poubelle de table



Behälter aus weiß lackiertem Metall, abnehmbarer Schwingdeckel
cover stainless steel bin metal, white, swing cover
tapa de acero inoxidable, recipiente chapa lacada blanca
couvercle inox basculant, récipient en acier laqué blanc

	Ø cm	↑ cm	ltr.	€
00291	12	17	1,2	14,00



Tischrestebehälter „INTERNATIONAL“

table waste bin
papelera de sobremesa
poubelle de table



Deckel-Ring mit Dichtung, internationale Beschriftung
cover with sealing ring
tapa con junta, texto multi-idomas
couvercle avec joint, texte multilingue

	Ø cm	↑ cm	ltr.	€
83847	10	17,5	1	9,00



02039

Tischrestebehälter

table garbage bin
papelera de sobremesa
poubelle de table



	Ø cm	↑ cm	ltr.	Farbe / Colour	€
02038	11	14	0,9	White	2,60
02039	11	14	0,9	Black	2,60



Tischreste- / Besteckbehälter

table garbage bin / cutlery bin
 papelera de sobremesa / recipiente para cubiertos
 poubelle de table / récipients pour couverts



matt poliert, mit abnehmbaren Lochdeckel
 satin polished finish, with removeable cover
 acabado pulido satinado, con tapa desmontable
 poli mat satiné, avec couvercle démontable ouvert au centre

	Ø cm	↑ cm	ltr.	€
00028	10	12	0,7	12,00



Table Caddy „COUNTRY STYLE“

table barrel
 caddy de mesa
 caddy de table



cooler Country-Style, nicht für den direkten Kontakt mit Lebensmittel verwendbar
 make for cool condiment and cutlery holders or even for food presentation, the mini barrels should not come into contact with food, they should be lined with our greaseproof paper
 estilo campo, no aptos para el contacto directo con alimentos, sólo usando papel alimenticio de style champêtre, pas de contact direct avec aliments, seulement en utilisant papier alimentaire

	Ø cm	↑ cm	€
11930	17,5	8,5	19,00
11931	11,5	14,0	19,00



Tischrestebehälter

table garbage bin
 papelera de sobremesa
 poubelle de table



matt poliert, abnehmbarer Schwingdeckel, mit Bajonettverschluss „fester Deckelsitz“
 satin polished finish, swing cover, cover removable
 acabado satinado, tapa basculante desmontable
 poli mat satiné, couvercle basculant démontable

	Ø cm	↑ cm	ltr.	€
00029	12	17	1,2	16,00
00027	10	13	0,7	12,00



Tischrestebehälter

table garbage bin
 papelera de sobremesa
 poubelle de table



Behälter (innen Ø 9 cm) für Besteck, Servietten etc., vielseitig einsetzbar
 bins (inner Ø 9 cm) for cutlery, napkins etc., versatile applicable
 recipientes Ø 9 cm para cubiertos, servilletas etc.
 récipients Ø 9 cm, pour couverts, serviettes,...

	Ø cm	↑ cm	ltr.	€
83999	13	14	1,2	11,50

Buffet & Display



Tischreste- / Besteckbehälter „TOP CHROME“

table waste bin / cutlery bin
papelera de sobremesa / recipiente para cubiertos
poubelle de table / récipients pour couverts



mit verchromten Rand
with chrome plated ring
con anillo cromado
avec bord chromé

	Ø cm	↑ cm	ltr.	Farbe / Colour	€
00025	13	15	1	White	6,00
00026	13	15	1	Black	6,00



Tischreste- / Besteckbehälter „BASE CHROME“

table waste bin / cutlery bin
papelera de sobremesa / recipiente para cubiertos
poubelle de table / récipients pour couverts



mit verchromten Boden
with chrome bottom
con base cromada
avec base chromée

	Ø cm	↑ cm	ltr.	Farbe / Colour	€
00019	13	15	1,3	White	6,00
00020	13	15	1,3	Black	6,00



Tischkrümelentferner

crumbler
recogemigas
ramasse-miettes



matt poliert
satin polished finish
acabado mate, fácil de usar, mango hueco
mat satiné, manche creux, simple à utiliser

	Ø cm	↑ cm		€
00058	6,5 x 2,5	22	Hohlgriff / hollow handles	14,80
00581	19 x 4,5	1	geschliffene Edelstahlkante flat grinded stainless steel edge	7,20



Besteckständer „TRIPLE TOWER“

cutlery basket
cesta para cubiertos
égouttoir à couverts



4-teiliges Set: 1 Gestell + 3 Köcher
4 pcs. set: 1 frame + 3 baskets
set de 4 piezas: 1 estructura + 3 cubiertos
set de 4 éléments: 1 structure + 3 corbeille

	cm	↑ cm	Farbe / Colour	€
11466	18 x 26	43	White	79,00
11467	18 x 26	43	Black	79,00



Besteckköcher

cutlery basket
cesta para cubiertos
corbeille à couverts



	cm	↑ cm	Farbe / Colour	€
84535	12 x 12	16	White	4,90
84536	12 x 12	16	Black	4,90



NEW

Besteckbehälter mit Tragegriff
cutlery bin with handle
recipiente para cubiertos con asa
récipient pour couverts avec poignée

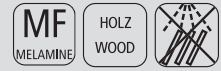

Besteckbehälter aus Melamin mit abnehmbaren Tragegriff aus Holz.
Der Steg ist mit 4 Gummibändern fixiert.

Cutlery bin made of melamine with removable wooden handle.
The handle is fixed with 4 rubber bands.

Recipiente de melamina para cubiertos con asa de madera extraíble.
El asa se fija con 4 cintas elásticas.

Récipient en mélamine pour couverts avec poignée en bois amovible.
La poignée est fixée avec 4 bandes élastiques.

	cm	↑ cm	ltr.	€
84870	23,5 x 17	18	2,1	24,00



matt poliert

Besteckständer
cutlery basket
cesta para cubiertos
égouttoir à couverts



	Ø cm	↑ cm	€
11921	10	10,0	7,40
11922	12	13,5	9,90



hot price

Tischrestebehälter
table garbage bin
papelera de sobremesa
poubelle de table



	Ø cm	↑ cm	ltr.	€
00311	14	15	1,2	3,60



hot price

Tischrestebehälter
table garbage bin
papelera de sobremesa
poubelle de table



Kunststoff weiß / Granit, abnehmbarer Schwingdeckel

white plastic, swing cover, cover removable

plástico blanco/granito, tapa basculante desmontable

plastique blanc/gris chiné, couvercle basculant démontable

	Ø cm	↑ cm	ltr.	€
00031	12	18	1,4	5,40



Tischreste- / Besteckbehälter
table waste bin / cutlery bin
papelera de sobremesa / recipiente para cubiertos
poubelle de table / récipients pour couverts



mit verchromten Rand, inkl. herausnehmbarem Einteiler (4 Fächer)

with chrome plated ring, incl. divider (4 chambers)

con anillo cromado, incl. divisor extraíble (4 compartimentos)

avec bod chrome, incl. paroi de separation amovible (4 compartiments)

	cm	↑ cm	€
00016	14 x 14	16	19,00



Serviettenhalter „ELEMENT“

napkin holder
servilletero
porte-serviettes

aus Beton, für ca. 50 Servietten, mit möbelschonender Unterseite
concrete, for approx. 50 napkins, with furniture-friendly underside
hormigón, para aprox. 50 servilletas, con base anti rayaduras
béton, pour environ 50 serviettes, avec revêtement antirayures



	cm	↑ cm	€
11781	16,0 x 7,5	10,0	9,00



Serviettenhalter

napkin holder
servilletero
porte-serviettes

hochglanzpoliert, für Servietten mit 1/8 Falz, Füße mit rutsch- und kratzfester Gummierung
mirror polished finish, for napkins with 1/8 fold, rubber feet
pulido brillante, para servilletas plegado 1/8, con revestimiento de goma
poli miroir, pour serviettes pliage 1/8, avec revêtement en caoutchouc



	cm	↑ cm	€
11720	10 x 11,5	18,5	11,60



Serviettenhalter

napkin holder
servilletero
porte-serviettes

möbelschonende Unterseite, für ca. 30 Servietten, matt poliert
furniture-friendly underside, for approx. 30 napkins, satin polished finish
con base anti rayaduras, para aprox. 30 servilletas, pulido mate
avec revêtement antirayures, pour environ 30 serviettes, poli mat



	cm	↑ cm	€
11780	15 x 4,5	12,5	6,20



Serviettenhalter

napkin holder
servilletero
porte-serviettes

möbelschonende Unterseite, für ca. 20 Servietten, matt poliert
furniture-friendly underside, for approx. 20 napkins, satin polished finish
con base anti rayaduras, para aprox. 20 servilletas, pulido mate
avec revêtement antirayures, pour environ 20 serviettes, poli mat



	cm	↑ cm	€
11778	17 x 3	7	6,40



Serviettenhalter

napkin holder
servilletero
porte-serviettes

möbelschonende Unterseite, für ca. 20 Servietten, hochglanzpoliert
furniture-friendly underside, for approx. 20 napkins, satin polished finish
con base anti rayaduras, para aprox. 20 servilletas, pulido mate
avec revêtement antirayures, pour environ 20 serviettes, poli mat



	cm	↑ cm	€
11777	17 x 3	7	6,40



Serviettenhalter „PROFI“

napkin holder
servilletero
porte-serviettes



für 150 Servietten 1/4 Falz, inkl. Beschwerer, mit Antirutschfüßchen, absolut standfest

for 150 napkins 1/4 fold, incl. weight, non-slip feet, very stable

para 150 servilletas plegado 1/4, incl. barra de contrapeso, con pies antideslizantes, muy estable

pour 150 serviettes pliage 1/4, incl. barre de contrepoids, avec pieds antidérapants, très stable

	cm	↑ cm	€
11766	18,5 x 18,5	18	35,00



Serviettenhalter „WIRE“

napkin holder
servilletero
porte-serviettes



für Servietten 1/4 Falz, inkl. Beschwerer

for napkins 1/4 fold, incl. weight

para servilletas plegado 1/4, incl. barra de contrapeso

pour serviettes pliage 1/4, incl. barre de contrepoids

	cm	↑ cm		€
11763	19 x 19	6,5	für 50 Servietten / for 50 napkins para 50 servilletas / pour 50 serviettes	5,90
11765	19 x 19	19	für 150 Servietten / for 150 napkins para 150 servilletas / pour 150 serviettes	9,40



Serviettenhalter „BAR“

napkin holder
servilletero
porte-serviettes



für ca. 50 Cocktailservietten, inkl. Beschwerer

for approx. 50 cocktail napkins, incl. weight

para aprox. 50 servilletas cocktail, incl. barra de contrapeso

pour environ 50 serviettes cocktail, incl. barre de contrepoids

	cm	↑ cm	€
11762	14 x 14	6,5	5,90



Serviettenhalter

napkin holder
servilletero
porte-serviettes



matt poliert

satin polished finish

acabado satinado

mat satiné

	cm	↑ cm	€
11730	17 x 17	5	16,80





Buffet & Tableware Melamin

Tablets
Schalen
Teller
Fingerfood
Eierbecher

bandejas
cuencos
platos
finger food
hueveras

trays
bowls
plates
finger food
egg holders

plateaux
bols
assiettes
finger food
coquetiers

UNIVERSAL



+ Kompatibilität / compatibility / combinación / compatibilité

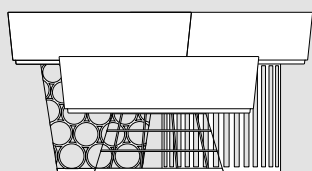

Baskets
risers

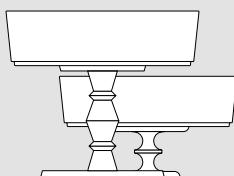

Wood
risers

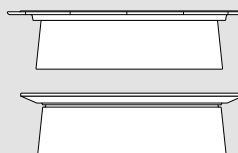

Bakery / Wood
plates

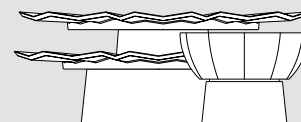

Lotus
bowls / plates



weiß; innen glänzend, außen matt
white; glossy on the inside, matt on the outside
blanco; interior brillante, exterior mate
blanc; intérieur brillant, extérieur mat



Holzdekor Ahorn & Farbe
maple wood decor & colour
textura de madera arce & color
aspect érable & couleur

bicolor
bicolour
bicolor
bicolore



Holzdekor Eiche dunkel & Farbe
oak wood decor & colour
textura de madera roble oscuro & color
aspect chêne foncé & couleur

bicolor
bicolour
bicolor
bicolore



Holzdekor Ahorn & cream

Holzdekor Ahorn & red

Holzdekor Ahorn & green

Holzdekor beige & cream

Holzdekor Eiche & cream

Holzdekor Eiche & red

Holzdekor Eiche & green

Holzdekor brown & cream



GN 1/4 Schale „UNIVERSAL“

GN 1/4 bowl
GN 1/4 cuenco
GN 1/4 bol



	cm	↑ cm	GN	ltr.	Farbe / Colour	€
15116	26,5 x 16,2	7	1/4	1,5		15,00
15117	26,5 x 16,2	9	1/4	2,5		17,00



Schale, quadratisch „UNIVERSAL“

bowl, square
cuenco cuadrado
bol carré



	cm	↑ cm	ltr.	Farbe / Colour	€
15110	6,5 x 6,5	6	0,15		2,20
15111	9 x 9	4	0,15		2,50
15112	13 x 13	7	0,6		6,00
15113	20 x 20	7	1,5		15,00
15114	24 x 24	9	3,5		22,00
15115	26,5 x 26,5	9	4		25,00



Schale, rund „UNIVERSAL“

bowl, round
cuenco, redondo
bol rond



	Ø cm	↑ cm	ltr.	Farbe / Colour	€
15100	6,5	6	0,15		2,00
15101	9,0	4	0,15		2,20
15102	13,0	7	0,6		5,50
15103	16,0	12	1,5		12,00
15104	16,0	15	2,5		14,00
15105	20,0	7	1,5		14,00
15106	24,0	9	2,7		18,00
15108	32,5	9	4		30,00



GN 1/4 Schale „UNIVERSAL“

GN 1/4 bowl
GN 1/4 cuenco
GN 1/4 bol



	cm	↑ cm	GN	ltr.	Farbe / Colour	€
15219	26,5 x 16,2	7	1/4	1,5		21,00
15220	26,5 x 16,2	9	1/4	2,5		24,00
15234	26,5 x 16,2	7	1/4	1,5		21,00
15235	26,5 x 16,2	9	1/4	2,5		24,00



Schale, quadratisch „UNIVERSAL“

bowl, square
bol cuadrado
plat creux carré



	cm	↑ cm	ltr.	Farbe / Colour	€
15215	13 x 13	7	0,6		8,50
15216	20 x 20	7	1,5		20,00
15217	24 x 24	9	3,5		30,00
15218	26,5 x 26,5	9	4		34,00
15232	20 x 20	7	1,5		20,00
15233	26,5 x 26,5	9	4		34,00



Schale, rund „UNIVERSAL“

bowl, round
cuenco, redondo
bol rond



	Ø cm	↑ cm	ltr.	Farbe / Colour	€
15230	20,0	7	1,5		17,00
15231	32,5	9	4		39,00



Schale „UNIVERSAL“

bowl
cuenco
bol



	Ø cm	↑ cm	ltr.	Farbe / Colour	€
15200	6,5	6	0,15		2,50
15201	9	4	0,15		2,80



Schale „UNIVERSAL“

bowl
cuenco
bol



	cm	↑ cm	ltr.	Farbe / Colour	€
15204	6,5 x 6,5	6	0,15		2,90
15205	9 x 9	4	0,15		3,20



Deckel „UNIVERSAL“

cover
tapa
couvercle



glasklar, mit Löffelaussparung
transparent, with notched for spoons
transparente, con espacio para la cuchara
transparent, avec encoche pour la louche

	cm	↑ cm	GN	€
15348	26,5 x 16,2	1,5	1/4	6,00

	cm	↑ cm	€
15345	20 x 20	1,5	5,60
15346	24 x 24	1,5	6,80
15347	26,5 x 26,5	1,5	8,00

	Ø cm	↑ cm	€
15340	16	1,5	4,50
15341	20	1,5	5,00
15342	24	1,5	6,00
15343	26,5	1,5	6,80
15344	32,5	1,5	10,00

ANTI PASTI

APS+



Buffet & Tableware
Melamin

+ Kompatibilität / compatibility / combinación / compatibilité

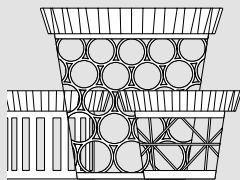

Baskets
risers

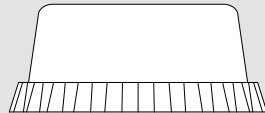

Cover
seal

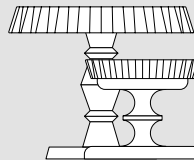

Wood
risers

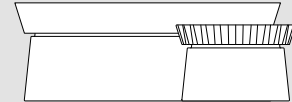

Bowls
risers



15141

Schale „PLISSEE“

bowl
cuenco
bol



	Ø cm	↑ cm	Farbe / Colour	€
15140	14,5	2,5	—	4,50
15141	25,0	3,5	—	13,00
15142	35,0	4,0	—	24,00



15135

Schale

bowl
cuenco
bol



	Ø cm	↑ cm	Farbe / Colour	€
15135	14,5	2,5	—	3,90
15136	25,0	3,5	—	9,90
15137	35,0	4,0	—	18,00



0,10 ltr.
15166

1,25 ltr.
15167

Schale Water Lily „LOTUS“

leaf
fuente en forma de hoja
plat feuille



	Ø cm	↑ cm	ltr.	Farbe / Colour	€
15165	8,5	4	0,1	—	2,90
15166	13	6	0,3	—	5,40
15167	20	7	1,25	—	13,50

TILES



+ Kompatibilität / compatibility / combinación / compatibilité

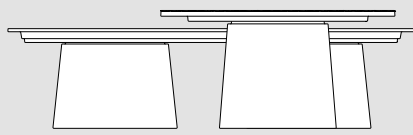

Bowls
risers

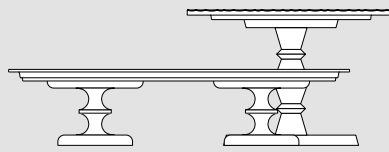

Wood
risers

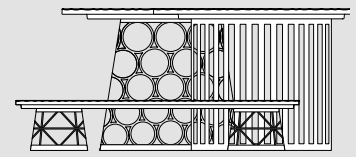

Baskets
risers



GN 1/1 Tablett „TILES“

GN 1/1 tray
GN 1/1 bandeja
GN 1/1 plateau



	cm	↑ cm	GN	Farbe / Colour	€
15120	53,0 x 32,5	2	1/1		29,90
15236	53,0 x 32,5	2	1/1		29,90



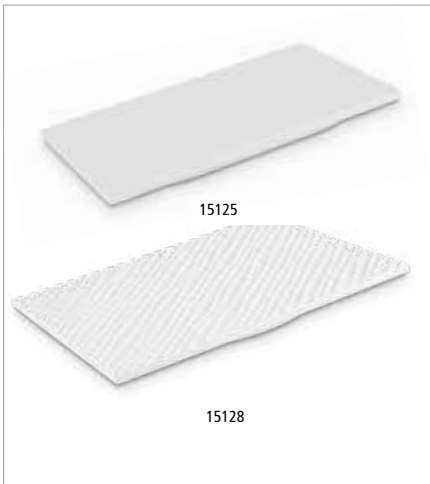

GN Tablett „TILES“

GN tray
GN bandeja
GN plateau



	cm	↑ cm	GN	Farbe / Colour	€
15125	26,5 x 16,2	1,5	1/4		13,00
15126	35,5 x 17,6	1,5	1/3		17,00
15128	32,5 x 26,5	1,5	1/2		24,00
15127	53,0 x 16,2	1,5	2/4		24,00

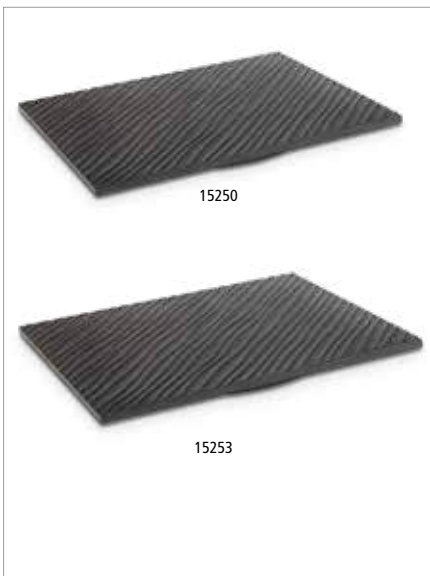

GN Tablett „TILES“

GN tray
GN bandeja
GN plateau



	cm	↑ cm	GN	Farbe / Colour	€
15250	26,5 x 16,2	1,5	1/4		13,00
15251	32,5 x 17,5	1,5	1/3		17,00
15253	32,5 x 26,5	1,5	1/2		24,00
15252	53,0 x 16,2	1,5	2/4		24,00



GN Tablett „TILES“

GN tray
GN bandeja
GN plateau



	cm	↑ cm	GN	Farbe / Colour	€
15225	26,5 x 16,2	1,5	1/4		15,00
15226	32,5 x 17,5	1,5	1/3		19,00
15228	32,5 x 26,5	1,5	1/2		26,00
15227	53,0 x 16,2	1,5	2/4		26,00



WOOD

+ Kompatibilität / compatibility / combinación / compatibilité

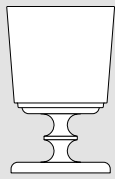

Universal
bowls

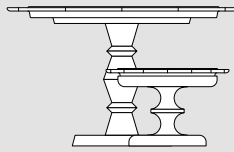

Tiles
plates

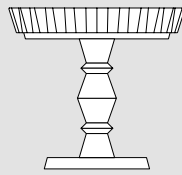

Antipasti
flat bowls

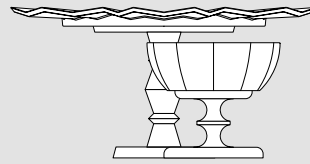

Lotus
plates / bowls

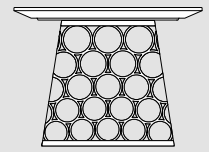

Baskets
risers

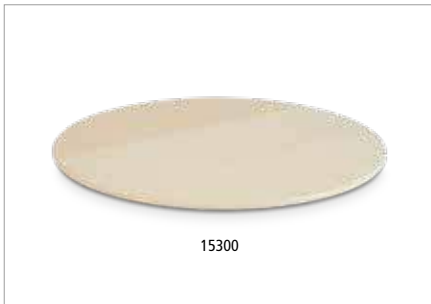

Tablett „WOOD“

tray
bandeja
plateau



	Ø cm	↑ cm	Farbe / Colour	€
15300	30,0	2		39,00
15302	38,5	2		49,00



Tablett „WOOD“

tray
bandeja
plateau



	Ø cm	↑ cm	Farbe / Colour	€
15301	30,0	2		39,00
15303	38,5	2		49,00



Ständer „WOOD“

stand
soporte
support



	Ø cm	↑ cm	Farbe / Colour	€
15310	15 / 11,5	10,5		39,00
15311	15 / 11,5	10,5		39,00



Ständer „WOOD“

stand
soporte
support



	Ø cm	↑ cm	Farbe / Colour	€
15312	21 / 15	20		49,00
15313	21 / 15	20		49,00

Hauben



Frischhalte-Haube

cover
campana
cloche bombée



glasklar, Griff verchromt, schwere, stabile Ausführung

transparent, chrome knob, heavy stable quality
transparente, asa cromada, alta estabilidad
transparente, anse chromée, très stable

	Ø cm	↑ cm	✂ mm	fits to	€
15350	16,5	10	3	15130	8,90
15351	20,5	10	3	15141, 15136, 15271, 15131	9,90



Frischhalte-Haube

cover
campana
cloche



	Ø cm	↑ cm	fits to	€
06512	30	11,5	15142, 15137, 15272, 15132	5,90
06517	33	12,5	15133, 15302, 15303	6,90



Rolltophaube

rolltop cover
campana abatible
cloche basculante



glasklarer Kunststoff, leichtgängig auf- und zuklappen 90°

solid quality, to be opened 90°
plástico transparente de alta calidad, apertura a 90°
plastique transparent résistant, ouverture 90°

	Ø cm	↑ cm	fits to	€
18388	38	20	15133, 15302, 15303	19,40



Haube

cover
campana
cloche



	Ø cm	↑ cm	fits to	€
06520 NEW	30	22	84242, 84177, 83892, 83891, 83890, 83884, 15303, 998, 975, 469, 468, 463, 462 46,	29,90

ASIA+



Nahezu alle ASIA+ Produkte verfügen über ein System von Ringen und Radien und können dadurch stand- und rutschfest miteinander kombiniert werden. So können beispielsweise alle Schalen auch als Riser / Aufsteller für unterschiedlichste weitere ASIA+ Produkte verwendet werden.

Nearly all ASIA+ products feature a system of rings and radii that allow them to be combined with each other in a stable manner. For example, all bowls can be used as risers for a wide range of other ASIA+ products. The same applies to the baskets.

Casi todos los productos de ASIA+ disponen de un sistema de anillos y radios que permiten su combinación entre sí con una estabilidad perfecta. Así por ejemplo, todos los cuencos se pueden utilizar también como pedestales para los productos más diversos de ASIA+. Y lo mismo ocurre con las cestas.

Presque tous les produits ASIA+ sont munis d'un système d'anneaux et de rayons, ce qui permet de les combiner entre eux de façon stable. Ainsi, tous les bols et saladiers servent aussi de rehausseurs pour les produits ASIA+ les plus divers. Il en va de même des corbeilles.



Tablett tray

Schale bowl



15523 / 15525
Tablett / tray

15524 / 15526
Zwischenplatte



Tablett „ASIA PLUS“

tray
bandeja
plateau



	Ø cm	↑ cm	Farbe / Colour	€
15530	30,0	3		22,00
15531	38,0	3		24,00
15532	48,5	3		34,00
15533	30,0	3		27,00
15534	38,0	3		34,00
15535	48,5	3		42,00



Tablett / Platte „ASIA PLUS“

tray
bandeja
plateau



	Ø cm	↑ cm		€
15523	38,0	2,5	einfach gefälzt / single seamed pliegue sencillo / plié une seule fois	34,00
15525	48,5	2,5	einfach gefälzt / single seamed pliegue sencillo / plié une seule fois	46,00



Zwischenplatte „ASIA PLUS“

intermediate plate
bandeja intermedia
plateau intermédiaire



	Ø cm	↑ cm		€
15524	38,0	2,5	doppelt gefälzt / double seamed pliegue doble / plié en double	34,00
15526	48,5	2,5	doppelt gefälzt / double seamed pliegue doble / plié en double	46,00

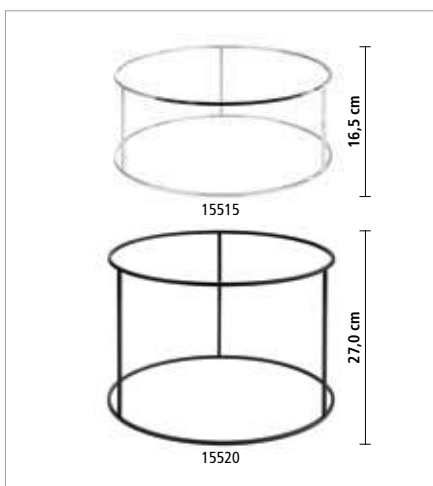

Buffetständer „ASIA PLUS“

buffet stand
soporte para buffet
présentoir buffet



	Ø cm	↑ cm	Farbe / Colour	€
15515	38,0	16,5		19,00
15516	38,0	27,0		22,00
15517	48,5	16,5		22,00
15518	48,5	27,0		29,00
15519	38,0	16,5		16,00
15520	38,0	27,0		19,00
15521	48,5	16,5		19,00
15522	48,5	27,0		26,00

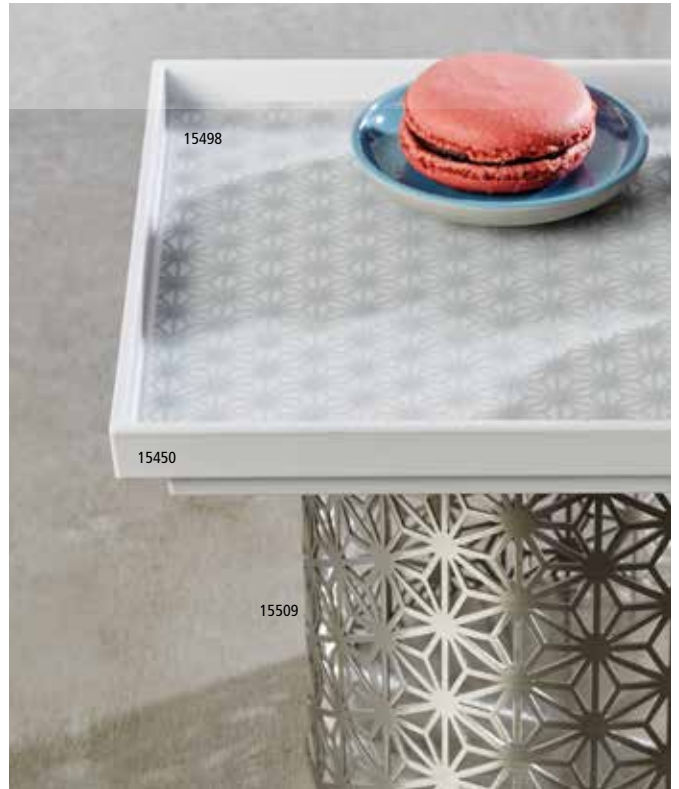

GN Tablett „ASIA PLUS“

GN tray
GN bandeja
GN plateau



	cm	↑ cm	GN	Farbe / Colour	€
15449	53,0 x 32,5	3	1/1		34,00
15450	32,5 x 26,5	3	1/2		19,00
15451	32,5 x 17,6	3	1/3		14,00
15452	26,5 x 16,2	3	1/4		11,00
15453	35,4 x 32,5	3	2/3		24,00
15454	53,0 x 16,2	3	2/4		22,00
15455	53,0 x 32,5	3	1/1		44,00
15456	32,5 x 26,5	3	1/2		25,00
15457	32,5 x 17,6	3	1/3		18,00
15458	26,5 x 16,2	3	1/4		15,00
15459	35,4 x 32,5	3	2/3		31,00
15460	53,0 x 16,2	3	2/4		28,00



Antirutschmatte „ASIA PLUS“

non slip mat
esterilla antideslizante
tapis antidérapant



	cm	fits to	€
15497	51,0 x 31,0	15449, 15455	12,00
15499	31,0 x 25,5	15450, 15456	7,40



Antirutschmatte „ASIA PLUS“

non slip mat
esterilla antideslizante
tapis antidérapant



	cm	fits to	€
15498	51,0 x 31,0	15449, 15455	12,00
15500	31,0 x 25,5	15450, 15456	7,40

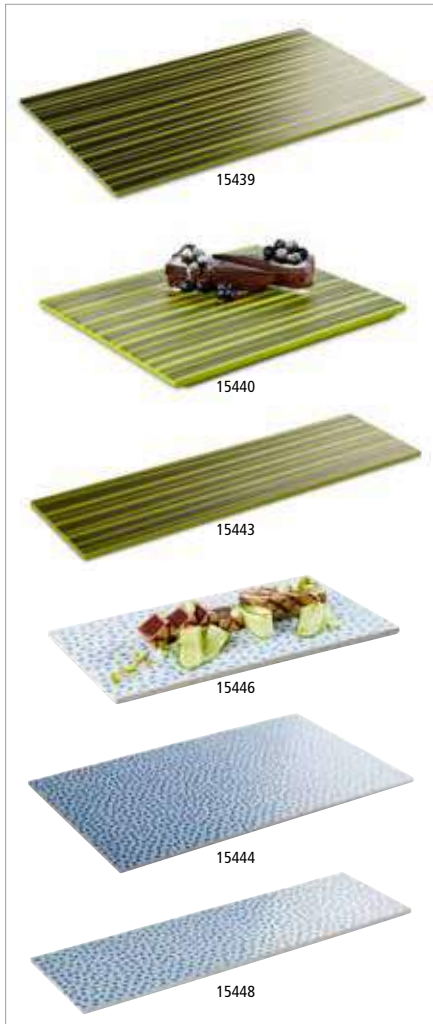

GN Tablett „ASIA PLUS“

GN tray
GN bandeja
GN plateau



	cm	↑ cm	GN	Farbe / Colour	€
15439	53,0 x 32,5	1,5	1/1		44,00
15440	32,5 x 26,5	1,5	1/2		25,00
15441	32,5 x 17,6	1,5	1/3		20,00
15442	26,5 x 16,2	1,5	1/4		16,00
15443	53,0 x 16,2	1,5	2/4		28,00
15444	53,0 x 32,5	1,5	1/1		44,00
15445	32,5 x 26,5	1,5	1/2		25,00
15446	32,5 x 17,6	1,5	1/3		20,00
15447	26,5 x 16,2	1,5	1/4		16,00
15448	53,0 x 16,2	1,5	2/4		28,00



GN 1/1	GN 1/2	GN 1/4	GN 2/4
	GN 1/2	GN 1/4	
GN 1/3	GN 1/3	GN 1/3	



Schale „ASIA PLUS“

bowl
cuenco
bol



	Ø cm	↑ cm	ltr.	Farbe / Colour	€
15400	7,5	3,5	0,06	■ ■	2,00
15401	9,5	4,5	0,13	■ ■	3,00
15402	13	5,5	0,35	■ ■	5,00
15403	16	7	0,60	■ ■	7,00
15404	20	8	1,10	■ ■	11,40
15405	24	9,5	2,20	■ ■	17,00
15406	26,5	11	3,00	■ ■	22,00
15407	32,5	12,5	5,40	■ ■	30,00
15408	7,5	3,5	0,06	■ ■	2,00
15409	9,5	4,5	0,13	■ ■	3,00
15410	13	5,5	0,35	■ ■	5,00
15411	16	7	0,60	■ ■	7,00
15412	20	8	1,10	■ ■	11,40
15413	24	9,5	2,20	■ ■	17,00
15414	26,5	11	3,00	■ ■	22,00
15415	32,5	12,5	5,40	■ ■	30,00
15416	7,5	3,5	0,06	■ ■	2,00
15417	9,5	4,5	0,13	■ ■	3,00
15418	13	5,5	0,35	■ ■	5,00
15419	16	7	0,60	■ ■	7,00
15420	20	8	1,10	■ ■	11,40
15421	24	9,5	2,20	■ ■	17,00
15422	26,5	11	3,00	■ ■	22,00
15423	32,5	12,5	5,40	■ ■	30,00



Deckel „UNIVERSAL“ mit Löffelaussparung

cover with notched for spoons
tapa con espacio para la cuchara
couvercle avec encoche pour la louche



	Ø cm	↑ cm	fits to	€
15340	16	1,5	15403, 15411, 15419	4,50
15341	20	1,5	15404, 15412, 15420	5,00
15342	24	1,5	15405, 15413, 15421	6,00
15343	26,5	1,5	15406, 15414, 15422	6,80
15344	32,5	1,5	15407, 15415, 15423	10,00



Teller „ASIA PLUS“
plate
plato
plato
assiette



	Ø cm	↑ cm	Farbe / Colour	€
15424	11	2		2,60
15425	16	2		4,60
15426	19,5	2		6,00
15427	24	2		9,00
15428	28	2		12,40

	Ø cm	↑ cm	Farbe / Colour	€
15429	11	2		2,60
15430	16	2		4,60
15431	19,5	2		6,00
15432	24	2		9,00
15433	28	2		12,40

	Ø cm	↑ cm	Farbe / Colour	€
15434	11	2		2,60
15435	16	2		4,60
15436	19,5	2		6,00
15437	24	2		9,00
15438	28	2		12,40



ASIA+





Bento Box „ASIA PLUS“



	Ø cm	↑ cm	ltr.	Farbe / Colour	€
15461	7,5	3	0,04		1,90
15462	7,5	6,5	0,13		2,60



	Ø cm	↑ cm	ltr.	Farbe / Colour	€
15467	7,5	3	0,04		2,70
15468	7,5	6,5	0,13		3,90



	cm	↑ cm	ltr.	Farbe / Colour	€
15473	7,5 x 7,5	3	0,05		2,00
15474	7,5 x 7,5	6,5	0,16		2,80
15479	15,5 x 15,5	3	0,19		5,20
15480	15,5 x 15,5	6,5	0,85		7,50



	cm	↑ cm	ltr.	Farbe / Colour	€
15485	7,5 x 7,5	3	0,05		3,40
15486	7,5 x 7,5	6,5	0,16		4,20
15491	15,5 x 15,5	3	0,19		9,00
15492	15,5 x 15,5	6,5	0,85		15,80



	cm	↑ cm	ltr.	Farbe / Colour	€
15475	15,5 x 7,5	3	0,10		3,40
15477	15,5 x 9,5	3	0,15		3,60
15476	15,5 x 7,5	6,5	0,40		4,60
15478	15,5 x 9,5	6,5	0,50		5,40
15483	25 x 15,5	3	0,30		8,00
15484	25 x 15,5	6,5	1,40		11,00



	cm	↑ cm	ltr.	Farbe / Colour	€
15487	15,5 x 7,5	3	0,10		6,40
15488	15,5 x 7,5	6,5	0,40		8,00
15489	15,5 x 9,5	3	0,15		7,20
15490	15,5 x 9,5	6,5	0,50		9,40
15495	25 x 15,5	3	0,30		11,60
15496	25 x 15,5	6,5	1,40		14,40

ASIA+



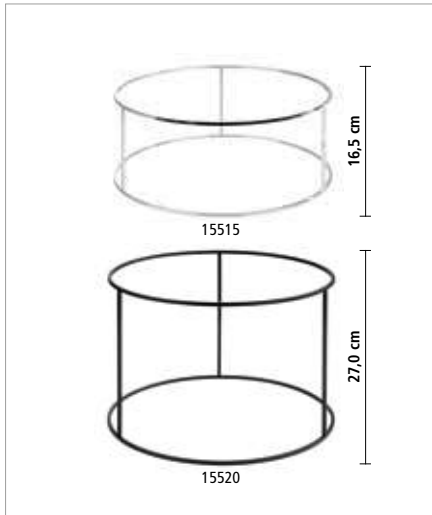

Buffetständer „ASIA PLUS“

buffet stand
soporte para buffet
présentoir buffet



	Ø cm	↑ cm	Farbe / Colour	€
15515	38,0	16,5	Grey	19,00
15516	38,0	27,0	Grey	22,00
15517	48,5	16,5	Grey	22,00
15518	48,5	27,0	Grey	29,00
15519	38,0	16,5	Black	16,00
15520	38,0	27,0	Black	19,00
15521	48,5	16,5	Black	19,00
15522	48,5	27,0	Black	26,00



GN Buffetständer „ASIA PLUS“

GN buffet stand
GN soporte para buffet
GN présentoir buffet



	cm	GN	Farbe / Colour	€
15501	53,0 x 32,5 / 53,0 x 16,2	1/1 / 2/4	Grey	24,00
15502	32,5 x 26,5 / 26,5 x 16,2	1/2 / 1/4	Grey	15,00
15503	32,5 x 17,5 / 35,4 x 32,5	1/3 / 2/3	Grey	19,00
15504	53,0 x 32,5 / 53,0 x 16,2	1/1 / 2/4	Black	19,00
15505	32,5 x 26,5 / 26,5 x 16,2	1/2 / 1/4	Black	12,00
15506	32,5 x 17,5 / 35,4 x 32,5	1/3 / 2/3	Black	15,00

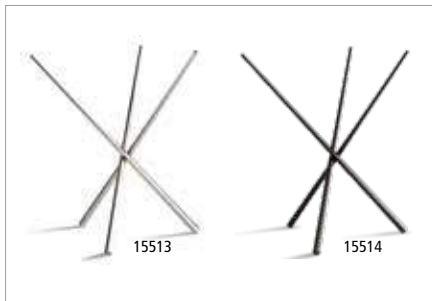

Buffetständer „ASIA PLUS“

buffet stand
soporte para buffet
présentoir buffet



	Ø cm	↑ cm	Farbe / Colour	€
15513	20,5 / 16,5	20	stainless steel	15,00
15514	20,5 / 16,5	20	Black	14,00



Buffetständer / -korb „ASIA PLUS“

buffet stand / basket
soporte para buffet / cestas
présentoir buffet / corbeilles



	Ø cm	↑ cm	Farbe / Colour	€
15507	15	10,5	Grey	44,00
15510	15	10,5	Black	44,00

	Ø cm	↑ cm	Farbe / Colour	€
15508	21	10,5	Grey	59,00
15511	21	10,5	Black	59,00

	Ø cm	↑ cm	Farbe / Colour	€
15509	21	20	Grey	79,00
15512	21	20	Black	79,00



NEW BLUE OCEAN

Da geht die Sonne auf!
Maritime Aquatöne,
Farbverläufe und klassisches
Blau-Weiß erinnert an eine
griechische Taverne in der
Ägäis.

The sun is rising!
Maritime aqua tones,
gradients and classic blue
and white reminiscent of
a Greek tavern in the
Aegean Sea.

¡Está saliendo el sol! Los tonos marinos, los degradados de color, el clásico azul y blanco recuerdan a una taberna griega en el mar Egeo.

Le soleil se lève! Les tons maritimes, les dégradés de couleurs, le bleu et le blanc classiques, tout rappellent une taverne grecque de la mer Égée.

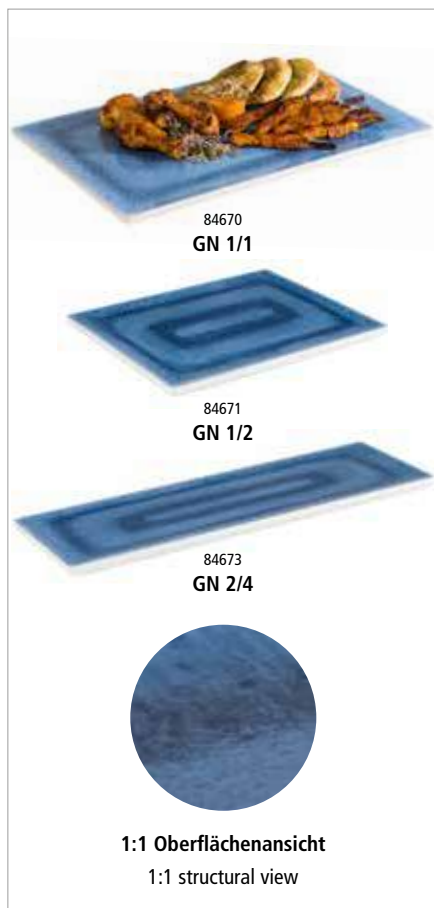

GN Tablett „BLUE OCEAN“

GN tray
GN bandeja
GN plateau

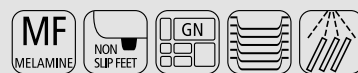

	cm	↑ cm	GN	€
84670	53,0 x 32,5	2	1/1	42,00
84671	32,5 x 26,5	2	1/2	22,00
84672	32,5 x 17,6	2	1/3	16,00
84673	53,0 x 16,2	2	2/4	24,00

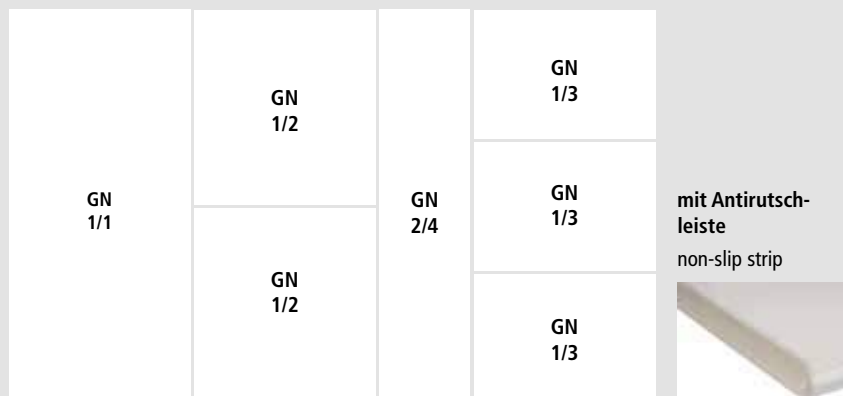



Tablett „BLUE OCEAN“

tray
bandeja
plateau



	cm	↑ cm	€
84676	48,0 x 35,5	3,0	19,00

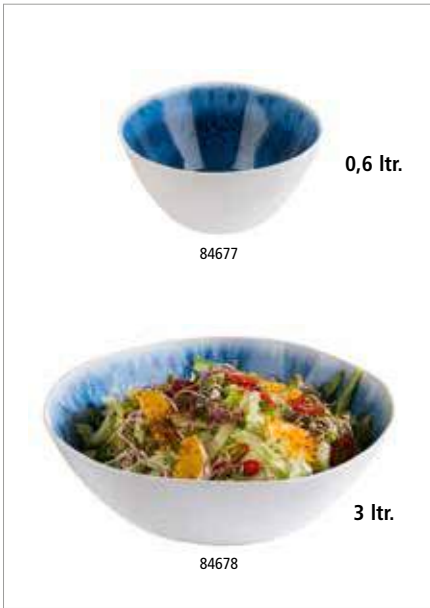

Schale „BLUE OCEAN“

bowl
cuenco
bol



	Ø cm	↑ cm	ltr.	€
84677	15,0	7,5	0,6	6,00

	Ø cm	↑ cm	ltr.	€
84678	30,5	9,0	3,0	16,00



Teller „BLUE OCEAN“

plate
plato
assiette



	Ø cm	↑ cm	€
84674	21,5	2,0	6,60
84675	26,5	2,0	8,00

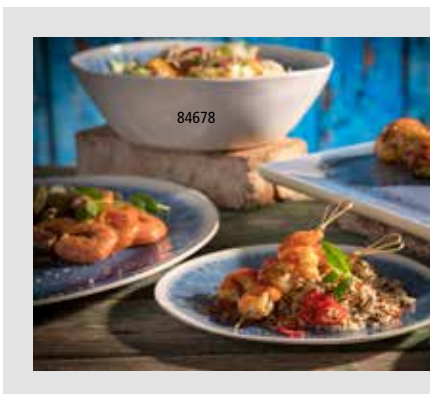

NEW

ARABESQUE



Beim Anblick der mediterranen Melamin Serie ARABESQUE bekommt man direkt Lust auf eine Tapas-Party. Mit seinem spanischen Charme und den wundervoll ausgearbeiteten Details holen Sie sich ein Stück Spanien auf Ihr Buffet.

When looking at the Mediterranean melamine series ARABESQUE, the longing for a tapas party resurfaces. With its Spanish charm and the beautifully crafted details, you get a slice of Spain on your buffet.

Al ver la serie mediterránea de melamina ARABESQUE, se obtiene un dicho antojo por una fiesta de tapas. Con su encanto español y los detalles bellamente elaborados, obtenga una rebanada de España en su buffet.

En regardant la série de mélamine méditerranéenne ARABESQUE, vous obtenez envie de préparer une fête de tapas. Avec son charme espagnol et les détails joliment ouverts, vous aurez une tranche d'Espagne sur votre buffet.



GN Tablett „ARABESQUE“

GN tray
GN bandeja
GN plateau



	cm	↑ cm	GN	€
84680	53,0 x 32,5	2	1/1	42,00
84681	32,5 x 26,5	2	1/2	22,00
84682	32,5 x 17,6	2	1/3	16,00
84683	53,0 x 16,2	2	2/4	24,00



mit Antirutschleiste
non-slip strip



Schale „ARABESQUE“

bowl
cuenco
bol



	Ø cm	↑ cm	ltr.	€
84687	10,0	6,0	0,2	4,00
84688	15,5	8,0	0,8	6,00

	Ø cm	↑ cm	ltr.	€
84689	20,5	5,5	1,1	8,90
84690	31,0	9,0	3,0	19,00



1:1 Oberflächenansicht

1:1 structural view



Teller „ARABESQUE“

plate
plato
assiette



	cm	↑ cm	€
84686	38 x15,5	2,0	12,00



Teller „ARABESQUE“

plate
plato
assiette



	Ø cm	↑ cm	€
84684	21,5	2,0	6,00
84685	26,5	2,0	8,00



Teller „BAMBOO“
plate
plato
assiette



	cm	↑ cm	€
84809	24,0 x 17,0	3,5	7,00



Schale „BAMBOO“
bowl
cuenco
bol



	cm	↑ cm	litr.	€
84815	10,5 x 10,0	3,0	0,03	2,50
84816	17,5 x 15,5	5,5	0,2	6,40



Schale „BAMBOO“
bowl
cuenco
bol



	Ø cm	↑ cm	litr.	€
84819	30,5	8,5	2	18,00



Schale „BAMBOO“
bowl
cuenco
bol



	cm	↑ cm	litr.	€
84817	18,0 x 17,5	5,5	0,3	8,00
84818	23,0 x 22,0	7,0	0,7	13,00



Tablett „BAMBOO“

tray
bandeja
plateau



	cm	↑ cm	€
84803	10,0 x 10,0	2,0	2,40
84804	14,5 x 14,5	2,5	3,60
84805	31,0 x 10,5	2,0	7,20
84806	21,0 x 13,0	3,0	5,00
84807	24,5 x 15,5	3,0	8,00
84808	34,5 x 21,5	3,0	16,00



GN Tablett „BAMBOO“

tray
bandeja
plateau

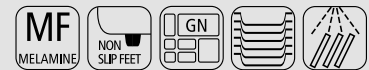

	cm	↑ cm	GN	€
84800	53,0 x 32,5	2,0	1 / 1	42,00
84801	32,5 x 26,5	2,0	1 / 2	22,00
84802	32,5 x 17,6	2,0	1 / 3	16,00



Tablett „BAMBOO“

tray
bandeja
plateau



	cm	↑ cm	€
84811	24,5 x 15,0	3,5	5,00
84812	32,5 x 19,0	4,5	7,00



Tablett „BAMBOO“

tray
bandeja
plateau



	cm	↑ cm	€
84813	40,0 x 25,5	3,0	16,00
84814	53,0 x 34,0	3,5	28,00



Tablett „BAMBOO“

tray
bandeja
plateau



	cm	↑ cm	€
84810	34,0 x 13,0	3,0	9,00

NEW

GREEN BAMBOO



Tablett „GREEN BAMBOO“

tray
bandeja
plateau



	cm	↑ cm	€
84640	22,0 x 12,0	3	6,00
84641	30,5 x 17,0	3	12,00



Schale „GREEN BAMBOO“

bowl
cuenco
bol



	Ø cm	↑ cm	litr.	€
84642	11,5	6,0	0,18	3,20

	Ø cm	↑ cm	litr.	€
84643	18,0	7,5	0,6	5,40
84644	20,5	8,5	0,9	8,40
84645	22,5	9,5	1,3	9,80



1:1 Oberflächenansicht
1:1 structural view



Schale „GREEN BAMBOO“

bowl
cuenco
bol



	Ø cm	↑ cm	ltr.	€
84646	17,0	9,5/13,0	0,8	8,00



700 ml

Topf „GREEN BAMBOO“

pot
recipiente
pot



für Dressing oder als Besteckhalter / for dressing or as a cutlery holder / para salsas o para cubiertos / pour des sauces ou pour des couverts

	Ø cm	↑ cm	ltr.	€
84647	11,0	14,5	0,7	14,00



Löffel „GREEN BAMBOO“

spoon
cuchara
cuillère



	cm	→ cm	ltr.	€
84648	6 x 4,5	20	0,01	2,00

	Ø cm	→ cm	ltr.	€
84649	6	21	0,02	2,40

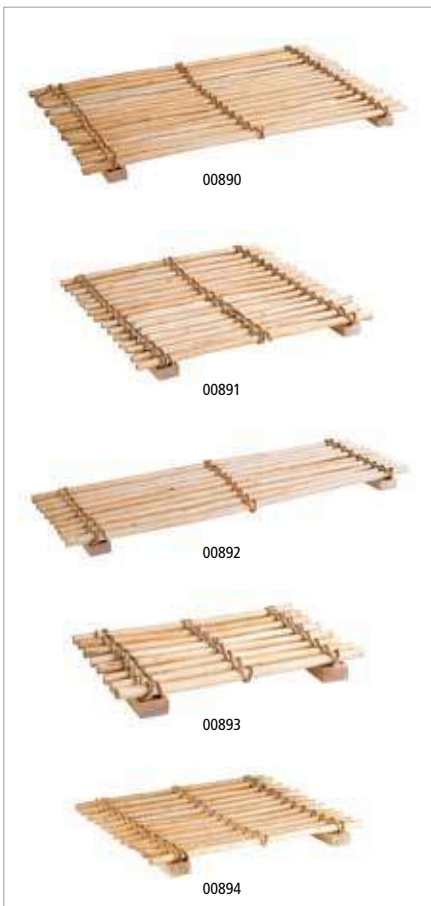

Untersetzer „BAMBOO“

coaster
posavasos
soucoupes



	~ cm	↑ cm	€
00890	53,0 x 32,5	3,0	10,00
00891	35,4 x 32,5	3,0	7,40
00892	53,0 x 16,2	3,0	7,20
00893	26,5 x 16,2	3,0	4,20
00894	32,5 x 26,5	3,0	6,40



HANOI



Die ansteigenden Schalenformen erzeugen eine asiatische Marktopitik und verleihen Ihrem Buffet durch die gewobene Oberflächenstruktur eine natürliche Authentizität.

The rising bowl forms create an Asian market look and give your buffet a natural authenticity through the woven surface structure.

La forma creciente de los cuencos crea un look de un mercado asiático y le dá a su buffet una autenticidad natural gracias a la estructura de la superficie tejida.

La forme croissante de bols crée un aspect visuel d'une marché asiatique et donne à votre buffet une authenticité naturelle à travers la structure de surface tissée.



Schale / Teller „HANOI“

bowl / plate
cuenco / plato
bol / assiette



	Ø cm	↑ cm	€
84725	25,5	3,0 / 6,5	12,00
84726	30,0	3,5 / 7,5	16,00
84727	35,5	4,0 / 9,0	20,00



AQUARIS

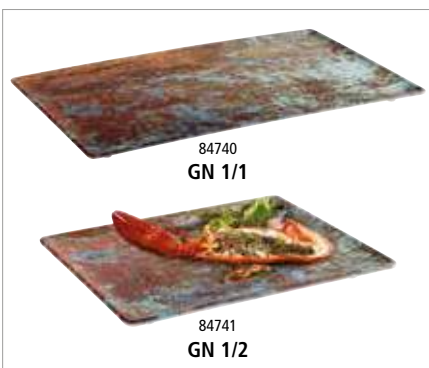

GN Tablett „AQUARIS“

GN tray
GN bandeja
GN plateau



	cm	↑ cm	GN	Farbe / Colour	€
84740	53,0 x 32,5	2	1/1		42,00
84741	32,5 x 26,5	2	1/2		23,00
84742	32,5 x 17,6	2	1/3		16,80
84743	53,0 x 16,2	2	2/4		25,00



Tablett „AQUARIS“

tray
bandeja
plateau



	cm	↑ cm	Farbe / Colour	€
84744	21,0 x 13,0	3		7,50
84745	34,5 x 22,0	3		20,00



Teller „AQUARIS“

plate
plato
assiette



	Ø cm	↑ cm	Farbe / Colour	€
84746	26	3,5		11,80
84747	35	3,0		25,00

	cm	↑ cm	Farbe / Colour	€
84748	24,0 x 17,0	3,5		8,40
84749	40,5 x 30,0	4		25,00

JADE



GN Tablett „JADE“

GN tray
GN bandeja
GN plateau



	cm	↑ cm	GN	€
84709	53,0 x 32,5	3	1/1	36,00
84710	32,5 x 26,5	3	1/2	21,00
84711	32,5 x 17,6	3	1/3	15,00
84712	53,0 x 16,2	3	2/4	23,00



Tablett / Sushiboard „JADE“

tray / sushiboard
bandeja para sushi
plateau sushi



	cm	↑ cm	€
84707	22,0 x 9,5	2,0	5,80
84708	22,5 x 13,5	3,5	7,00

NEW



0,7 ltr.

84835



1,45 ltr.

84836



2,3 ltr.

84837

Schale „ELEMENT LOOK“

bowl
cuenco
bol



	Ø cm	↑ cm	ltr.	€
84835	21,5	5,5 / 9,5	0,7	22,00
84836	26,0	7,0 / 12,5	1,45	26,00
84837	30,0	8,5 / 14,5	2,3	36,00



mit Antirutschfüßchen / with non-slip feet / con pies antideslizantes / avec pieds antidérapants



GN Tablett „IRON“
GN tray
GN bandeja
GN plateau

	cm	↑ cm	GN	€
84884	32,5 x 26,5	2	1/2	12,00
84885	26,5 x 16,2	2	1/4	7,40
84886	53,0 x 16,2	2	2/4	14,00



Schale „IRON“
GN bowl
GN cuenco
GN bol

	cm	↑ cm	GN	litr.	€
84880	32,5 x 26,5	8,5	1/2	3,5	16,00
84881	26,5 x 16,2	8,5	1/4	1,4	12,00
84882	53,0 x 16,2	8,5	2/4	3,2	19,00
84883	25,0 x 25,0	10,0	-	2,8	14,00

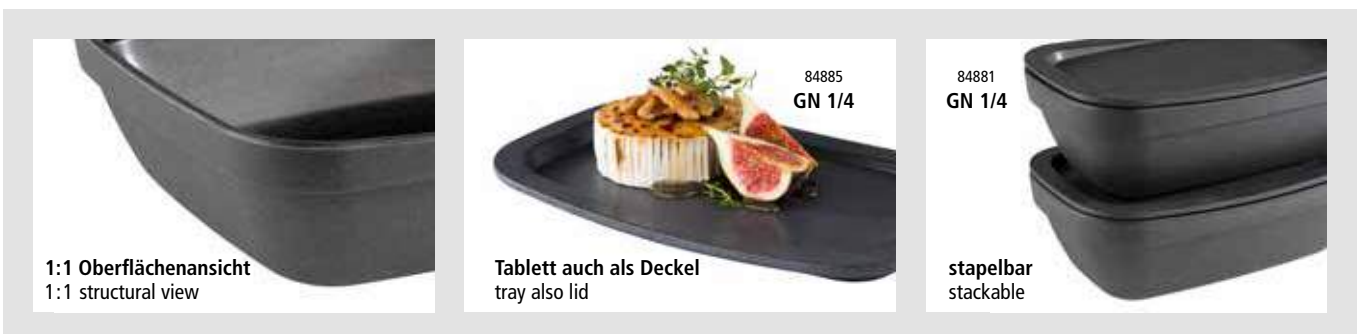



Teller „STONE ART“
plate
plato
assiette



	Ø cm	↑ cm		€
84510	19,0	2,0		7,00
84511	25,0	2,0		11,00
84512	30,0	2,0		15,50



Teller „STONE ART“
plate
plato
assiette



	Ø cm	↑ cm	ltr.	€
84509	15,5	2,5	0,15	5,20
84514	20,0	4,5	0,60	8,90



Teller „STONE ART“
plate
plato
assiette



	Ø cm	↑ cm		€
84515	24,5	3,5		12,00



Teller „STONE ART“
plate
plato
assiette



	cm	↑ cm		€
84517	33,0 x 32,5	3,0		22,00



Schale „STONE ART“

bowl
cuenco
bol



	Ø cm	↑ cm	litr.	€
84523	8,0	3,0	0,07	2,10



Schale „STONE ART“

bowl
cuenco
bol



	Ø cm	↑ cm	litr.	€
84524	12,0	6,0	0,3	4,50



Schale „STONE ART“

bowl
cuenco
bol



	Ø cm	↑ cm	litr.	€
84525	15,0	7,5	0,6	5,80



Schale „STONE ART“

bowl
cuenco
bol



	cm	↑ cm	litr.	€
84526	23,0 x 19,0	6,5	0,6	10,50



Schale „STONE ART“

bowl
cuenco
bol



	cm	↑ cm	litr.	€
84528	28,5 x 21,0	7,5	1,2	17,00



Schale „STONE ART“

bowl
cuenco
bol



	cm	↑ cm	litr.	€
84529	19,0 x 19,0	6,0	0,5	11,50
84530	24,0 x 24,0	6,5	1,1	16,00

Buffet & Tableware Melamin



GN Tablett „STONE ART“

GN tray
GN bandeja
GN plateau



	cm	↑ cm	GN	€
84519	53,0 x 32,5	1,5	1/1	42,00
84520	32,5 x 26,5	1,5	1/2	23,00
84522	53,0 x 16,2	1,5	2/4	24,00
84521	32,5 x 17,6	1,5	1/3	17,00



mit Antirutschfüßchen
with non-slip feet
con pies antideslizantes
avec pieds antidérapants



GN Abdeckhaube

GN cover
GN cubierta
GN cloche



passend für GN Tablett, glasklarer Kunststoff, nahezu unzerbrechlich
suitable for GN trays, clear plastic, nearly unbreakable
apto para bandejas GN, plástico transparente, muy resistente a la rotura
pour bacs et plateaux GN, plastique transparent, très résistant à la casse

	cm	↑ cm	* mm	GN	€
11043 NEW	32,5 x 17,6	10,5	3	1/3	15,00
11044 NEW	53,0 x 16,2	10,5	3	2/4	20,00

	cm	↑ cm	* mm	GN	€
11041	32,5 x 26,5	9,5	3	1/2	20,00
11042	53,0 x 32,5	9,5	3	1/1	28,00

AIKO



Schale „AIKO“

bowl
cuenco
bol



Steinoptik

appearance stoneware
su aspecto recuerda al gres
l'aspect de la mélamine rapelle le grès

	cm	↑ cm	ltr.	Farbe / Colour	€
84327	26,5 x 19,5	6	0,9	■	9,90



Schale „AIKO“

bowl
cuenco
bol



Steinoptik

appearance stoneware
su aspecto recuerda al gres
l'aspect de la mélamine rapelle le grès

	Ø cm	↑ cm	ltr.	Farbe / Colour	€
84328	8	4	0,07	■	3,20
84330	11,5	6	0,2	■	4,20

	Ø cm	↑ cm	ltr.	Farbe / Colour	€
84329	8	4	0,07	■	3,20
84331	11,5	6	0,2	■	4,20



Schale „AIKO“

bowl
cuenco
bol



Steinoptik

appearance stoneware
su aspecto recuerda al gres
l'aspect de la mélamine rapelle le grès

	Ø cm	↑ cm	ltr.	Farbe / Colour	€
84334	16	7	0,6	■	6,80
84336	20,5	8	1,2	■	10,50

	Ø cm	↑ cm	ltr.	Farbe / Colour	€
84335	16	7	0,6	■	6,80
84337	20,5	8	1,2	■	10,50



Betonoberflächen auf dem Buffet für den Kontakt mit Lebensmitteln? ELEMENT macht es möglich. Bestens geeignet im modernen und urbanen Ausstattungsumfeld.

Concrete surfaces on the buffet for food contact? ELEMENT makes it possible. Ideally suited for modern and urban environments.

¿Superficies de hormigón en el buffet y tener contacto con alimentos? ELEMENT lo hace posible. Ideal para ambientes modernos y urbanos.

Des surfaces en béton sur le buffet et destinées au contact alimentaire? ELEMENT le rend possible. Idéal pour les environnements modernes et urbains.



Schale „ELEMENT“
bowl
cuenco
bol

	cm	↑ cm	ltr.	€
84825	∅ 8,0	2,0	0,01	1,20
84826	10,5 x 10,0	3,0	0,02	2,60
84820	9,0 x 7,0	3,0	0,03	2,60
84821	10,5 x 10,5	3,0	0,04	2,90
84827	17,5 x 15,5	5,5	0,18	6,00

Melamine icons: MF MELAMINE, stack of bowls, and heat resistance symbol.



Tablett „ELEMENT“
tray
bandeja
plateau

	cm	↑ cm	€
84822	20,0 x 9,5	2,5	6,00

Melamine icons: MF MELAMINE, stack of trays, and heat resistance symbol.



Tablett „ELEMENT“
tray
bandeja
plateau

	cm	↑ cm	€
84824	31,0 x 10,5	1,5	8,00

Melamine icons: MF MELAMINE, stack of trays, and heat resistance symbol.



Tablett „ELEMENT“

tray
bandeja
plateau



	cm	↑ cm	€
84823	22,5 x 15,0	3,0	9,00



Schale „ELEMENT“

bowl
cuenco
bol



	Ø cm	↑ cm	litr.	€
84828	16,0	7,0	0,5	7,00
84829	28,0	12,0	3,0	21,00



Schale „ELEMENT“

bowl
cuenco
bol



	cm	↑ cm	litr.	€
84830	19 x 19	9,0	1,5	21,00
84831	25 x 25	12,0	3,8	32,00



GN Tablett „ELEMENT“

GN tray
GN bandeja
GN plateau



	cm	↑ cm	GN	€
84400	53,0 x 32,5	3,5	1/1	35,00
84401	32,5 x 26,5	3,5	1/2	19,00
84402	32,5 x 17,5	3,5	1/3	14,00
84403	26,5 x 16,2	3,5	1/4	11,00
84404	53,0 x 16,2	3,5	2/4	21,00

GLAMOUR



Schalen und Tablets in elegant matt-schwarz, mit glänzenden Sprenkeln, „Hingucker“ für Tisch und Buffet.

Bowls and trays in elegant matte black color with glossy spots, an eye-catcher for table and buffet.

Cuencos y bandejas en color negro mate elegante con una superficie brillante con salpicaduras, una atracción para su mesa y buffet.

Bols et plateaux en couleur noir mat élégant avec une surface brillante mouchetée, point de mire pour la table et le buffet.



Schale „GLAMOUR“

bowl
cuenco
bol



	∅ cm	↑ cm	ltr.	€
84365	8	3	0,05	1,40



Schale „GLAMOUR“

bowl
cuenco
bol



	∅ cm	↑ cm	ltr.	€
84366	12	5	0,35	1,80



Schale „GLAMOUR“

bowl
cuenco
bol



	∅ cm	↑ cm	ltr.	€
84367	15	8	0,70	4,40



Schale „GLAMOUR“
bowl
cuenco
bol



	cm	↑ cm	ltr.	€
84373	19,5 x 9	5	0,2	2,90
84374	21,5 x 14,5	4,5	0,3	3,90



Tablett „GLAMOUR“
tray
bandeja
plateau



	cm	↑ cm	€
84375	26,5 x 8,5	2	2,40
84376	33,5 x 11	3	4,00



Tablett „GLAMOUR“
tray
bandeja
plateau



	cm	↑ cm	€
84377	22 x 12	3	3,20
84378	37 x 11	2,5	9,00



Tablett „GLAMOUR“
tray
bandeja
plateau



	cm	↑ cm	€
84380	25 x 15,5	1,5	2,90
84381	30,5 x 19	1,5	4,40



Tablett „GLAMOUR“
tray
bandeja
plateau



	cm	↑ cm	€
84379	30 x 11	3	4,90

LAGOON



Servierartikel mit kupferfarbenem Rand. Schlicht und zeitlos. Ideal für den Einsatz im Außenbereich (Pool, Spa, etc.).

Serving items with copper-colored border. Simple and timeless. Ideal for outdoor use (pool, spa, etc.).

Artículos de servicio con borde de color cobre. Simple e intemporal. Ideal para uso al aire libre (piscina, spa, etc.).

Pièces de service avec bord couleur cuivre. Simple et intemporel. Idéal pour une utilisation à l'extérieur (piscine, spa, etc.).



Teller „LAGOON“

plate
plato
assiette



	Ø cm	↑ cm		€
84540	20,0	2,5	flacher Teller / flat plate	3,90
84541	22,5	2,5	flacher Teller / flat plate	4,90



Teller „LAGOON“

plate
plato
assiette



	Ø cm	↑ cm		€
84543	22,5	3,0	tiefer Teller / deep plate	4,20
84542	28,0	3,0	tiefer Teller / deep plate	7,40



Teller „LAGOON“

plate
plato
assiette



	cm	↑ cm		€
84544	24 x 24	2,5		6,90



Tablett „LAGOON“

tray
bandeja
plateau



	cm	↑ cm	€
84545	21,5 x 14,5	2	3,40
84546	24,5 x 16,5	2	4,90



Schale „LAGOON“

bowl
cuenco
bol



	Ø cm	↑ cm	ltr.	€
84551	9,5	4,5	0,1	1,90



Schale „LAGOON“

bowl
cuenco
bol



	cm	↑ cm	ltr.	€
84552	14,5 x 14,5	7,0	0,6	3,90



Schale „LAGOON“

bowl
cuenco
bol



	cm	↑ cm	ltr.	€
84553	19 x 19	9	1,5	18,00
84554	25 x 25	12	3,8	29,00

Deckel „PURE“ mit Löffelussparung / cover with notched for spoons / tapa con espacio para la cuchara / couvercle avec encoche pour la louche

	cm	↑ cm	fits to	€
83600	19 x 19	1,5	84553	8,00
83601	25 x 25	1,5	84554	10,50



Tasse / Untertasse „LAGOON“

cup / saucer
taza / platillo
tasse / soucoup



	Ø cm	↑ cm	ltr.	€
84549	14	2	Kaffeuntertasse / saucer	2,40
84550	8	6	Kaffeetasse / cup	3,00

CROCKER



Servier- und Buffetartikel in Tonoptik, brauner Rand. Die Oberfläche ist innen und außen fein-matt, fühlt sich an wie Ton.

Serving and buffet items, an imitation of clay, with a brown border. The surface is inside and outside fine-matt. Feels like real clay.

Artículos de servicio y buffet, imitación barro y con borde marron. La superficie de dentro y de fuera es de deslustre fino. Parece barro natural.

Pièces de service et pour le buffet imitation argile avec bord marron. La surface est à l'intérieur et à l'extérieur bien-matte.



Teller „CROCKER“

plate
plato
assiette



	cm	↑ cm	Farbe / Colour	€
84567	14 x 13	2,5		3,00
84568	14 x 13	2,5		3,00



Teller „CROCKER“

plate
plato
assiette



	Ø cm	↑ cm	litr.	Farbe / Colour	€
84575	20,5	3	0,50		5,80
84576	20,5	3	0,50		5,80



Schale „CROCKER“

bowl
cuenco
bol



	Ø cm	↑ cm	ltr.	Farbe / Colour	€
84573	16,5	4	0,50		5,20
84574	16,5	4	0,50		5,20



84569
Ø 12,5 cm

84572
Ø 16,0 cm

84577
Ø 21,0 cm

Schale „CROCKER“

bowl
cuenco
bol



	Ø cm	↑ cm	ltr.	Farbe / Colour	€
84569	12,5	6	0,37		3,20
84570	12,5	6	0,37		3,20
84571	16,0	7	0,70		5,40
84572	16,0	7	0,70		5,40
84577	21,0	8	1,45		9,40
84578	21,0	8	1,45		9,40



84579

84581

Blattschale „CROCKER“

leaf
fuente en forma de hoja
plateau feuille



	cm	↑ cm	ltr.	Farbe / Colour	€
84579	30,5 x 10,0	7,5	0,17		6,00
84580	30,5 x 10,0	7,5	0,17		6,00
84581	42,0 x 14,0	9,5	0,65		14,00
84582	42,0 x 14,0	9,5	0,65		14,00

NEW

FRIDA



Auf der kurzen und der langen Seite aufstellbar!

Can stay on the short or long side!
Se puede colocar por la parte corta o larga!
Se peut installer sur le côté court ou long!

GN Buffetständer

GN buffet stand
GN soporte para buffet
GN présentoir buffet



	cm	GN	Farbe / Colour	€
15504	53,0 x 32,5 / 53,0 x 16,2	1/1 / 2/4	■	19,00
15505	32,5 x 26,5 / 26,5 x 16,2	1/2 / 1/4	■	12,00

NEW



84601
GN 1/1



84602
GN 1/2



84603
GN 1/4



84604
GN 2/4

GN Tablett „FRIDA“

GN tray
GN bandeja
GN plateau



	cm	↑ cm	GN	€
84601	53,0 x 32,5	2	1/1	42,00
84602	32,5 x 26,5	2	1/2	22,00
84603	26,5 x 16,2	2	1/4	14,00
84604	53,0 x 16,2	2	2/4	24,00



mit Antirutschfüßchen
with non-slip feet
con pies antideslizantes
avec pieds antidérapants



Schale „FRIDA“

bowl
cuenco
bol



	Ø cm	↑ cm	ltr.	Farbe / Colour	€
84605	12,5	4,5	0,25		9,00
84606	12,5	4,5	0,25		9,00
84607	15,0	5,5	0,44		15,00
84608	15,0	5,5	0,44		15,00
84609	20,0	7,5	1,2		22,00
84610	20,0	7,5	1,2		22,00



Schale „FRIDA“

bowl
cuenco
bol



	Ø cm	↑ cm	ltr.	Farbe / Colour	€
84611	22,0	10,5	2,2		24,00
84612	22,0	10,5	2,2		24,00
84613	26,5	10,5	3,4		30,00
84614	26,5	10,5	3,4		30,00



mit Antirutschfüßchen
with non-slip feet
con pies antideslizantes
avec pieds antidérapants



Tablett „FRIDA“

tray
bandeja
plateau



	cm	↑ cm	Farbe / Colour	€
84650	21,5 x 10,0	2,0		6,00
84651	21,5 x 10,0	2,0		6,00
84652	27,0 x 12,0	2,5		9,00
84653	27,0 x 12,0	2,5		9,00
84654	36,0 x 16,5	3,0		14,00
84655	36,0 x 16,5	3,0		14,00



Schale „FRIDA“

bowl
cuenco
bol



	cm	↑ cm	Farbe / Colour	€
84615	32,0 x 25,0	3,5		26,00
84616	32,0 x 25,0	3,5		26,00

Buffet & Tableware Melamin



GN 1/9 Schale „FRIDA“

GN 1/9 bowl
GN 1/9 cuenco
GN 1/9 bol



	Ø cm	↑ cm	GN	ltr.	Farbe / Colour	€
84555	17,6 x 10,8	5,5	1/9	0,5	White/Yellow	8,00
84556	17,6 x 10,8	5,5	1/9	0,5	Black/Yellow	8,00



GN 1/6 Schale „FRIDA“

GN 1/6 bowl
GN 1/6 cuenco
GN 1/6 bol



	Ø cm	↑ cm	GN	ltr.	Farbe / Colour	€
84583	17,6 x 16,2	7,5	1/6	1,0	White/Yellow	12,40
84584	17,6 x 16,2	7,5	1/6	1,0	Black/Yellow	12,40



GN 1/4 + 2/4 Schale „FRIDA“

GN 1/4 + 2/4 bowl
GN 1/4 + 2/4 cuenco
GN 1/4 + 2/4 bol



	Ø cm	↑ cm	GN	ltr.	Farbe / Colour	€
84586	26,5 x 16,2	7,5	1/4	1,8	White/Yellow	19,00
84587	26,5 x 16,2	7,5	1/4	1,8	Black/Yellow	19,00

	Ø cm	↑ cm	GN	ltr.	Farbe / Colour	€
84564	53,0 x 16,2	7,5	2/4	3,65	White/Yellow	25,00
84565	53,0 x 16,2	7,5	2/4	3,65	Black/Yellow	25,00



GN 1/2 Schale

GN 1/2 bowl
GN 1/2 cuenco
GN 1/2 bol



	Ø cm	↑ cm	GN	ltr.	Farbe / Colour	€
84589	32,5 x 26,5	7,5	1/2	4,0	White/Yellow	26,00
84590	32,5 x 26,5	7,5	1/2	4,0	Black/Yellow	26,00



Schale „FRIDA“

bowl
cuenco
bol



	cm	↑ cm	ltr.	Farbe / Colour	€
84558	16,5 x 16,5	5,5	0,85	White / Yellow	8,80
84559	16,5 x 16,5	5,5	0,85	Black / Yellow	8,80



Schale „FRIDA“

bowl
cuenco
bol



	cm	↑ cm	ltr.	Farbe / Colour	€
84561	25,0 x 25,0	7,5	2,65	White / Yellow	16,40
84562	25,0 x 25,0	7,5	2,65	Black / Yellow	16,40



GN 1/4 Tablett „FRIDA“

GN 1/4 tray
GN 1/4 bandeja
GN 1/4 plateau



	cm	↑ cm	ltr.	Farbe / Colour	€
84595	26,5 x 16,2	3	1/4	White / Yellow	12,00
84596	26,5 x 16,2	3	1/4	Black / Yellow	12,00



Tablett „FRIDA“

tray
bandeja
plateau



	cm	↑ cm	ltr.	Farbe / Colour	€
84598	35,5 x 26,0	3		White / Yellow	18,50
84599	35,5 x 26,0	3		Black / Yellow	18,50



Schale „FRIDA“

bowl
cuenco
bol



	cm	↑ cm	ltr.	Farbe / Colour	€
84592	25,0 x 25,0	12,0	3,5	White / Yellow	26,00
84593	25,0 x 25,0	12,0	3,5	Black / Yellow	26,00

Deckel „PURE“ mit Löffelaussparung / cover with notched for spoons / tapa con espacio para la cuchara / couvercle avec encoche pour la louche

	cm	↑ cm	fits to	€
83601	25 x 25	1,5	84561, 84562, 84592, 84593, 84594	10,50

Buffet & Tableware Melamin



Schale „FRIDA STONE“

bowl
cuenco
bol



	cm	↑ cm	ltr.	Farbe / Colour	€
84560	16,5 x 16,5	5,5	0,85		8,80



Schale „FRIDA STONE“

bowl
cuenco
bol



	cm	↑ cm	ltr.	Farbe / Colour	€
84563	25,0 x 25,0	7,5	2,65		16,40



GN 1/4 Tablett „FRIDA STONE“

GN 1/4 tray
GN 1/4 bandeja
GN 1/4 plateau



	cm	↑ cm	GN	Farbe / Colour	€
84597	26,5 x 16,2	3	1/4		12,00



Tablett „FRIDA STONE“

tray
bandeja
plateau



	cm	↑ cm	Farbe / Colour	€
84600	35,5 x 26,0	3		18,50



84594

Schale „FRIDA STONE“

bowl
cuenco
bol



	cm	↑ cm	ltr.	Farbe / Colour	€
84594	25,0 x 25,0	12,0	3,5		26,00

Deckel „PURE“ mit Löffelaussparung / cover with notched for spoons / tapa con espacio para la cuchara / couvercle avec encoche pour la louche

	cm	↑ cm	fits to	€
83601	25 x 25	1,5	84561, 84562, 84592, 84593, 84594	10,50



GN 1/9 Schale „FRIDA STONE“

GN 1/9 bowl
GN 1/9 cuenco
GN 1/9 bol



	cm	↑ cm	GN	ltr.	Farbe / Colour	€
84557	17,6 x 10,8	5,5	1/9	0,5	■	8,00



GN 1/6 Schale „FRIDA STONE“

GN 1/6 bowl
GN 1/6 cuenco
GN 1/6 bol



	cm	↑ cm	GN	ltr.	Farbe / Colour	€
84585	17,6 x 16,2	7,5	1/6	1,0	■	12,40



GN 1/4 Schale

GN 1/4 bowl
GN 1/4 cuenco
GN 1/4 bol



	cm	↑ cm	GN	ltr.	Farbe / Colour	€
84588	26,5 x 16,2	7,5	1/4	1,8	■	19,00



GN 1/2 Schale „FRIDA STONE“

GN 1/2 bowl
GN 1/2 cuenco
GN 1/2 bol



	cm	↑ cm	GN	ltr.	Farbe / Colour	€
84591	32,5 x 26,5	7,5	1/2	4,0	■	26,00



GN 2/4 Schale „FRIDA STONE“

GN 2/4 bowl
GN 2/4 cuenco
GN 2/4 bol



	cm	↑ cm	GN	ltr.	Farbe / Colour	€
84566	53,0 x 16,2	7,5	2/4	3,65	■	25,00

FLOWER POT



Schale „FLOWER POT“

bowl
cuenco
bol



	Ø cm	↑ cm	ltr.	Farbe / Colour	€
84470	6	3,5	0,04		1,20
84471	6	3,5	0,04		1,20
84472	6	3,5	0,04		1,20

	Ø cm	↑ cm	ltr.	Farbe / Colour	€
84473	9	8,5	0,30		4,00
84474	9	8,5	0,30		4,00
84475	9	8,5	0,30		4,00

	Ø cm	↑ cm	ltr.	Farbe / Colour	€
84476	12	3,5	0,20		3,20
84478	12	3,5	0,20		3,20

	Ø cm	↑ cm	ltr.	Farbe / Colour	€
84479	13	15	1,00		12,00
84481	13	15	1,00		12,00

	Ø cm	↑ cm	ltr.	Farbe / Colour	€
84482	20	9	1,80		14,00
84484	20	9	1,80		14,00

Deckel „UNIVERSAL“ mit Löffelaussparung / cover with notched for spoons
tapa con espacio para la cuchara / couvercle avec encoche pour la cuillère

	Ø cm	↑ cm	fits to	€
15341	20	1,5	84482, 84483, 84484	5,00

OAK



Tablett „OAK“

tray
bandeja
plateau



	cm	↑ cm	→ cm	€
84431	17,5 x 14,5	1,5	Griff / handle 6,5	7,00
84432	22,0 x 12,0	2,0	Griff / handle 11,0	8,00



Tablett „OAK“

tray
bandeja
plateau



	cm	↑ cm	€
84433	20,0 x 20,0	2,5	8,00



Schale „OAK“

bowl
cuenco
bol



	cm	↑ cm	€
84434	11,5 x 7,0	2,5	3,80
84435	25,0 x 6,5	3,5	6,20



GN Tablett „OAK“

GN tray
GN bandeja
GN plateau

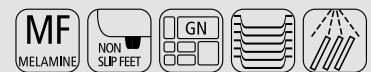

Eichenoptik
oak wood effect
imitación madera de roble
imitation chêne

	cm	↑ cm	GN	€
84720	53,0 x 32,5	1	1/1	38,00
84721	32,5 x 26,5	1	1/2	20,00
84722	32,5 x 17,6	1	1/3	14,00
84723	26,5 x 16,2	1	1/4	11,00
84724	53,0 x 16,2	1	2/4	22,00

OAK LIGHT



Die Melaminplatten (Holzoptik Eiche hell) haben eine leichte Struktur und wirken optisch wie aus Holz gefertigt.

The melamine trays (wood look light oak) have a lightweight structure and look visually as made of wood.

Las bandejas de melamina (imitación madera de roble claro) tienen una estructura ligera y parecen estar hechas de madera.

Les plateaux de mélamine (imitation bois de chêne clair) ont une structure légère et donnent une impression visuelle de bois.



Tablett „OAK LIGHT“

tray
bandeja
plateau



	Ø cm	↑ cm	€
84262	35	3	25,00
84263	44	3	38,00



Tablett „OAK LIGHT“

tray
bandeja
plateau



	cm	↑ cm	€
84264	44 x 25	1,5	20,00



Tablett „OAK LIGHT“

tray
bandeja
plateau



	cm	↑ cm	€
84265	65 x 26	3	30,00

OAK LIGHT GN



HOLZ OPTIK



84205
GN 1/1



84206
GN 1/2



84207
GN 1/3

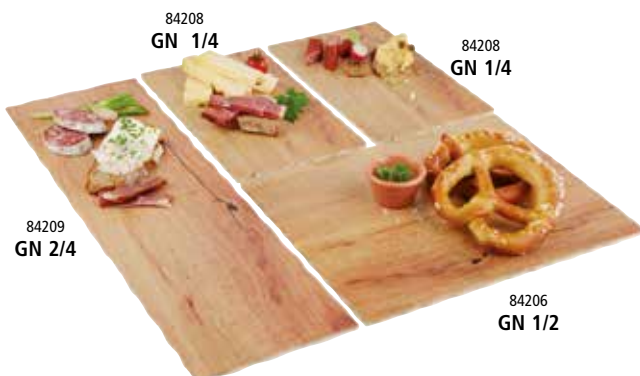

84208
GN 1/4

84208
GN 1/4

84209
GN 2/4

84206
GN 1/2

GN Tablett „OAK LIGHT“

GN tray
GN bandeja
GN plateau



	cm	↑ cm	GN	€
84205	53,0 x 32,5	1,5	1/1	35,00
84206	32,5 x 26,5	1,5	1/2	18,40
84207	32,5 x 17,6	1,5	1/3	13,00
84208	26,5 x 16,2	1,5	1/4	10,50
84209	53,0 x 16,2	1,5	2/4	21,00



Holzoptik Eiche hell

wood look oak light
aspecto madera, roble claro
aspect bois chêne clair



mit Antirutschfüßchen

with non-slip feet
con pies antideslizantes
avec pieds antidérapants

GN 1/1	GN 1/2	GN 1/4	GN 2/4
	GN 1/2	GN 1/4	
GN 1/3	GN 1/3	GN 1/3	



Die Melaminplatten (Holzoptik Fichte) haben eine leichte Struktur und wirken optisch wie aus Holz gefertigt.

The melamine trays (superb spruce wood effect - timber) have a lightweight structure and look visually as made of wood.

Las bandejas de melamina (imitación madera de picea) tienen una estructura ligera y parecen estar hechas de madera.

Les plateaux de mélamine (imitation bois d'épicéa) ont une structure légère et donnent une impression visuelle de bois.



Tablett „TIMBER“
tray
bandeja
plateau



	Ø cm	↑ cm	€
84266	35	3	25,00
84267	44	3	38,00



Tablett „TIMBER“
tray
bandeja
plateau



	cm	↑ cm	€
84268	44 x 25	1,5	20,00



Tablett „TIMBER“
tray
bandeja
plateau



	cm	↑ cm	€
84269	65 x 26	3	30,00



Tablett „TIMBER“
tray
bandeja
plateau



	cm	↑ cm	€
84256	70 x 26	3	59,00

OAK



Die Melaminplatten (Holzoptik Eiche) haben eine leichte Struktur und wirken optisch wie aus Holz gefertigt.

The melamine trays (superb oak wood effect) have a lightweight structure and look visually as made of wood.

Las bandejas de melamina (imitación madera de roble) tienen una estructura ligera y parecen estar hechas de madera.

Les plateaux de mélamine (imitation bois de chêne) ont une structure légère et donnent une impression visuelle de bois.



Tablett „OAK“

tray
bandeja
plateau



	∅ cm	↑ cm	→ cm	€
84177	30	1,5	Griff / handle 12	21,00



Tablett „OAK“

tray
bandeja
plateau



	cm	↑ cm	→ cm	€
84178	40,0 x 20,0	1,5	Griff / handle 13	26,00



Tablett „OAK“

tray
bandeja
plateau



	cm	↑ cm	→ cm	€
84179	48,0 x 20,0	1,5	Griff / handle 13	32,00



Buffet & Tableware Melamin



GN Tablett „ROCKFACE“

GN tray
GN bandeja
GN plateau



die Melaminplatten (Steinoptik) haben eine leicht wellige Oberfläche und wirken optisch wie ein Naturstein

the melamine trays (imitation of stone) have a slightly wavy surface and look visually as made of natural stone

las bandejas de melamine (imitación piedra) tienen una superficie ligeramente ondulada y parecen estar hechas de piedra natural

les plateaux de mélamine (imitation pierre) ont une surface légèrement ondulée et donnent une impression visuelle de pierre naturelle

	cm	↑ cm	GN	€
84770	53,0 x 32,5	1,5	1/1	36,00
84771	32,5 x 26,5	1,5	1/2	19,50
84772	32,5 x 17,6	1,5	1/3	14,00
84773	26,5 x 16,2	1,5	1/4	11,20
84774	53,0 x 16,2	1,5	2/4	22,00



1:1 Oberflächenansicht

1:1 structural view



GN Tablett „MARBLE“

GN tray
GN bandeja
GN plateau



Marmor-Look, glatte und hochglänzende Oberfläche

marble-look, smooth and shiny surface

look mármol, superficie lisa con acabado brillante

look de marbre, surface lisse et finition brillante

	cm	↑ cm	GN	€
84360	53,0 x 32,5	1,5	1/1	36,00
84361	32,5 x 26,5	1,5	1/2	19,50
84362	32,5 x 17,6	1,5	1/3	14,00
84363	26,5 x 16,2	1,5	1/4	11,20
84364	53,0 x 16,2	1,5	2/4	22,00



1:1 Oberflächenansicht

1:1 structural view



GN Tablett „ZERO“

GN tray
GN bandeja
GN plateau

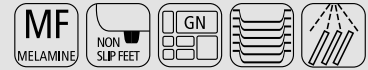

glatte, hochglänzende Oberfläche
smooth and shiny surface
superficie lisa con acabado brillante
surface lisse et finition brillante

	cm	↑ cm	GN	Farbe / Colour	€
84185	53,0 x 32,5	1,5	1/1		34,00
84186	32,5 x 26,5	1,5	1/2		18,20
84187	32,5 x 17,6	1,5	1/3		12,80
84188	26,5 x 16,2	1,5	1/4		10,40
84189	53,0 x 16,2	1,5	2/4		20,00
84195	53,0 x 32,5	1,5	1/1		34,00
84196	32,5 x 26,5	1,5	1/2		18,20
84197	32,5 x 17,6	1,5	1/3		12,80
84198	26,5 x 16,2	1,5	1/4		10,40
84199	53,0 x 16,2	1,5	2/4		20,00



GN Tablett „DRIFTWOOD“

GN tray
GN bandeja
GN plateau

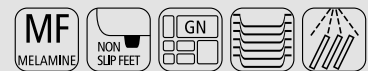

die Melaminplatten (Holzoptik) haben eine leicht wellige Oberfläche und wirken optisch wie aus Holz gefertigt
the melamine trays (wood look) have a slightly wavy surface and look visually as made of natural wood
las bandejas de melamine (imitación madera) tienen una superficie ligeramente ondulada y parecen estar hechas de madera natural
les plateaux de mélamine (imitation bois) ont une surface légèrement ondulée et donnent une impression visuelle de bois naturelle

	cm	↑ cm	GN	€
84180	53,0 x 32,5	1,5	1/1	35,00
84181	32,5 x 26,5	1,5	1/2	18,40
84182	32,5 x 17,6	1,5	1/3	13,00
84183	26,5 x 16,2	1,5	1/4	10,50
84184	53,0 x 16,2	1,5	2/4	21,00



1:1 Oberflächenansicht
1:1 structural view

SLATE



Die schwarzen Melaminplatten überzeugen mit ihrem edlen und schlichten Schieferlook und einer rauhen Oberfläche.

The black melamine trays convince with their noble and simple slate look and a rough surface.

Las bandejas de melamina negras convencen por su aspecto de pizarra elegante y discreto y una superficie áspera.

Les plateaux en mélamine noirs convainquent grâce au aspect de l'ardoise élégant et discret et une surface rugueuse.



83992



83994

Tablett „SLATE“
tray
bandeja
plateau



	Ø cm	↑ cm	€
83992	30	1	18,90
83994	40	1	30,00



GN Tablett „SLATE“

GN tray
GN bandeja
GN plateau



	cm	↑ cm	GN	€
83981	53,0 x 32,5	1,5	1/1	40,00



Schieferoptik
slate look



GN Tablett „SLATE“

GN tray
GN bandeja
GN plateau

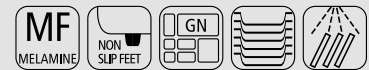

	cm	↑ cm	GN	€
83955	53,0 x 32,5	1	1/1	38,00
83956	32,5 x 26,5	1	1/2	20,00
83957	32,5 x 17,6	1	1/3	13,80
83958	26,5 x 16,2	1	1/4	11,00
83971	53,0 x 16,2	1	2/4	22,00



GN Tablett „SLATE“

GN tray
GN bandeja
GN plateau



massive Metallgriffe verchromt inkl. fest verschraubten 4 cm Distanzstücken
chrome plated handles, incl. mounted 4 cm distance pillars
asas cromadas, incluye distanciadores a 4 cm
poignées chromées, distance approx. 4 cm

	cm	↑ cm	GN	€
83980	53,0 x 32,5	6	1/1	47,00



Schale „SLATE“

bowl
cuenco
bol



	cm	↑ cm	litr.	€
84244	19,0 x 19,0	9	1,5	20,00
84245	25,0 x 25,0	12	3,8	34,00

Deckel „PURE“ mit Löffelaussparung / cover with notched for spoons

tapa con espacio para la cuchara / couvercle avec encoche pour la louche

	cm	↑ cm	fits to	€
83600	19 x 19	1,5	84244	8,00
83601	25 x 25	1,5	84245	10,50

Buffet & Tableware Melamin



Tablett „SLATE“

tray
bandeja
plateau



	Ø cm	↑ cm	→ cm		€
84241	23,0	1,5	10	Ø Loch 2 cm	12,80
84242	33,5	1,5	14	Ø Loch 2,5 cm	25,00

Frischhalte- Haube / cover / campana/ cloche



	Ø cm	↑ cm	fits to	€
06520 NEW	30	22	84242, 84177, 83892, 83891, 83890, 83884, 15303, 998, 975, 469, 468, 463, 462 46,	29,90
15351	20,5	10	8424	9,90



Tablett „SLATE-ROCK“

tray
bandeja
plateau



Die schwarzen Melaminplatten überzeugen mit ihrem Schieferlook
The black melamine trays convince with their slate look
Las bandejas de melamina negras convencen por su aspecto de pizarra
Les plateaux en mélamine noirs convainquent grâce au aspect de l'ardoise

	cm	↑ cm	€
84246	20 x 10	2	6,20
84247	30 x 10	2	8,40
84248	30 x 15	2	10,60

SLATE ROCK



Buffet & Tableware
Melamin



Tablett „SLATE-ROCK“

tray
bandeja
plateau



Die schwarzen Melaminplatten überzeugen mit ihrem Schieferlook
 The black melamine trays convince with their slate look
 Las bandejas de melamina negras convencen por su aspecto de pizarra
 Les plateaux en mélamine noirs convainquent grâce au aspect de l'ardoise

	∅ cm	↑ cm	→ cm	€
84257	30	1,5	Griff 12	20,00
	cm	↑ cm	→ cm	€
84258	40 x 20	1,5	Griff 13	25,00
84259	48 x 20	1,5	Griff 13	30,00

Buffet & Tableware Melamin



Tablett „SLATE ROCK“

tray
bandeja
plateau



	Ø cm	↑ cm	fits to	€
84630	36	3,0	6512	29,00
84631	39	3,0	6517	32,00



mit Füßchen
with feet

Frischhalte-Haube / cover / campana / cloche

	Ø cm	↑ cm		€
06512	30	11,5	mit verchromtem Griff / with chrome plated handle con pomo cromado / avec bouton chromé	5,90



Tablett „SLATE ROCK“

tray
bandeja
plateau



	Ø cm	↑ cm	fits to	€
84632	33	5,5	6512	24,00
84633	36	5,5	6517	29,00



Wendeplatte
turning plate

Frischhalte-Haube / cover / campana / cloche

	Ø cm	↑ cm		€
06517	33	12,5	mit verchromtem Griff / with chrome plated handle con pomo cromado / avec bouton chromé	6,90



Schale „REEF“

bowl
cuenco
bol



	Ø cm	↑ cm	ltr.	€
84850	13,0	7,0	0,45	4,90
84851	16,0	8,5	0,90	7,40
84852	21,5	11,5	2,0	9,90



Schale „REEF“

bowl
cuenco
bol



	Ø cm	↑ cm	ltr.	€
84853	20,0 x 20,0	9,0	1,8	16,00
84854	26,0 x 26,0	12,0	4,0	24,00
84855	32,5 x 32,5	14,5	8,0	34,00



NEW

CIRCLE



Tablett „CIRCLE“

plate / tray
plato / bandeja
assiette / plateau



	Ø cm	↑ cm	Farbe / Colour	€
84875	32,0	3,5		28,00
84876	40,5	5,5		40,00



LA VIDA



Tablett „LA VIDA“

plate / tray
plato / bandeja
assiette / plateau



	Ø cm	↑ cm	Farbe / Colour	€
84165	32,0	3,5		28,00
84168	40,5	5,5		40,00
<hr/>				
	Ø cm	↑ cm	Farbe / Colour	€
84161	32,0	3,5		28,00
84170	40,5	5,5		40,00
<hr/>				
	Ø cm	↑ cm	Farbe / Colour	€
84171	32,0	3,5		28,00
84172	40,5	5,5		40,00



NEW

DARK WAVE



GN Tablett „DARK WAVE“

GN tray
GN bandeja
GN plateau



	cm	↑ cm	GN	€
84900	53,0 x 32,5	2	1/1	39,00
84901	32,5 x 26,5	2	1/2	20,00
84902	32,5 x 17,6	2	1/3	12,00
84903	53,0 x 16,2	2	2/4	19,00



Tablett „DARK WAVE“

tray
bandeja
plateau



	cm	↑ cm	€
84904	14 x 14	2	4,40



Tablett „DARK WAVE“

tray
bandeja
plateau



	cm	↑ cm	€
84905	23,0 x 10,5	1,5	6,00
84906	29,0 x 12,0	1,5	8,00



Teller „DARK WAVE“

plate
plato
assiette



	Ø cm	↑ cm	€
84907	14,5	1,5	3,20
84908	22,0	2,0	6,60
84909	27,0	2,5	10,00



Schale „DARK WAVE“

bowl
cuenco
bol



	Ø cm	↑ cm	litr.	€
84910	17,5	5,0	0,50	7,40
84911	22,5	5,0	0,75	9,40
84912	32,0	3,5	-	16,00
84913	40,5	5,5	-	28,00



Schale „DARK WAVE“

bowl
cuenco
bol



	cm	↑ cm	litr.	€
84914	18,0 x 18,0	10,0	1,6	12,00
84915	23,0 x 23,0	11,5	2,9	18,00

MARONE



Eine derbe Oberflächenstruktur schafft ein natürliches Erscheinungsbild. Die schwarzen Schalenvarianten mit braunem Rand inszenieren Ihr Gericht sehr stilvoll.

A rough surface structure creates a natural appearance. The black bowls and trays with brown border stage your dishes in a very stylish way.

La estructura rugosa de la superficie crea una apariencia natural. Los diferentes cuencos negros con borde marron ponen con mucho estilo en escena sus platos.

La structure de surface rugueuse crée une apparence naturelle. Les différents bols noirs avec rebord marron mettent élégamment en scène vos plats.



Blattschale „MARONE“

leaf
fuente en forma de hoja
plateau feuille



	cm	↑ cm	ltr.	€
84100	25,5 x 14	5,5	0,4	8,20
84101	36 x 19	8	0,9	12,40



Tablett „MARONE“

tray
bandeja
plateau



	cm	↑ cm	€
84104	22,5 x 15	3	10,00
84105	27,5 x 11	2	10,00



Tablett „MARONE“

tray
bandeja
plateau



	cm	↑ cm	€
84103	14,5 x 14,5	2	5,40



Tablett „MARONE“

tray
bandeja
plateau



	cm	↑ cm	€
84106	26,5 x 16,5	4	11,60



Schale „MARONE“

bowl
cuenco
bol



	cm	↑ cm	litr.	€
84731	16,5 x 10,0	5,5	0,25	10,00
84732	22,0 x 13,0	7,5	0,6	12,00
84733	27,5 x 19,0	9,0	1,4	14,00



Teller „MARONE“

plate
plato
assiette



	Ø cm	↑ cm	€
84728	16,0	2,5	6,80
84729	20,5	2,5	7,20
84730	28,0	3,5	8,80



Schale „MARONE“

bowl
cuenco
bol



	Ø cm	↑ cm	litr.	€
84109	11	5,5	0,2	5,20



Schale „MARONE“

bowl
cuenco
bol



	Ø cm	↑ cm	litr.	€
84107	8,5	2,5	0,03	5,00
84108	11,5	3	0,05	5,40

Buffet & Tableware Melamin



Tablett „MARONE“

tray
bandeja
plateau



	cm	↑ cm	€
84117	19,5 x 9,5	2,0	8,40
84118	39,0 x 16,0	3,0	16,50



Tablett „MARONE“

tray
bandeja
plateau



	cm	↑ cm	€
84119	32,5 x 23,5	4,5	16,50



Schale „MARONE“

bowl
cuenco
bol



	Ø cm	↑ cm	ltr.	€
84174	30,5	8,5	2,0	20,00



Schale „MARONE“

bowl
cuenco
bol



	Ø cm	↑ cm	ltr.	€
84110	14	6	0,30	6,40
84111	19	8	0,80	11,60
84112	21	8,5	1,00	12,00
84113	24	9,5	1,40	14,00



Schale „MARONE“

bowl
cuenco
bol



	cm	↑ cm	ltr.	€
84114	23,5 x 23,5	6,5	0,70	12,40



Schale „MARONE“

bowl
cuenco
bol



	Ø cm	↑ cm	ltr.	€
84115	11	3,5	0,13	5,40
84116	14	4	0,20	6,00

ZEN



Fernöstliche Tisch- und Buffetartikel präsentiert die Serie ZEN. Die Optik entspricht dem japanischen Steingut.

The ZEN series presents Far Eastern table and buffet articles. The appearance is that of Japanese stoneware.

La colección ZEN presenta artículos de buffet y mesa para la cocina oriental. Su aspecto recuerda al gres japonés.

La collection ZEN présente des articles de buffet et de table pour la cuisine orientale. L'aspect de la mélamine rappelle le grès japonais.



Schale „ZEN“
bowl
cuenco
bol



	Ø cm	↑ cm	Farbe / Colour	€
83928	31	8,5	White	22,00
83929	31	8,5	Black	22,00



Schale „ZEN“
bowl
cuenco
bol



	Ø cm	↑ cm	ltr.	Farbe / Colour	€
84354	22,5	12,5	0,80	White	10,20
84355	22,5	12,5	0,80	Black	10,20



Schale „ZEN“
bowl
cuenco
bol





	cm	↑ cm	ltr.	Farbe / Colour	€
83710	21 x 21	11	1,4	White	11,00
83712	21 x 21	11	1,4	Black	11,00



Schale „ZEN“
bowl
cuenco
bol

MELAMINE MF  



	Ø cm	↑ cm	ltr.	Farbe / Colour	€
84348	10	7	0,08		2,80
84350	12,5	8,5	0,15		4,20
84352	16	10	0,30		6,80



	Ø cm	↑ cm	ltr.	Farbe / Colour	€
84349	10	7	0,08		2,80
84351	12,5	8,5	0,15		4,20
84353	16	10	0,30		6,80



 **stapelbar**
stackable



Schale „ZEN“
bowl
cuenco
bol



MELAMINE MF  



	cm	↑ cm	ltr.	Farbe / Colour	€
83733	25 x 13,5	4	0,25		4,20
83737	30,5 x 17,5	5	0,60		8,40

	cm	↑ cm	ltr.	Farbe / Colour	€
83735	25 x 13,5	4	0,25		4,20
83739	30,5 x 17,5	5	0,60		8,40



Schale „ZEN“
bowl
cuenco
bol

MELAMINE MF  

	cm	↑ cm	ltr.	Farbe / Colour	€
83714	17,5 x 17,5	7	0,5		6,60
83716	17,5 x 17,5	7	0,5		6,60



Schale „ZEN“
bowl
cuenco
bol

MELAMINE MF  

	cm	↑ cm	ltr.	Farbe / Colour	€
83725	10,5 x 10,5	3	0,06		2,50
83727	10,5 x 10,5	3	0,06		2,50



Dipschälchen „ZEN“

dip bowl
cuenco para dip
bol para dip



	Ø cm	↑ cm	ltr.	Farbe / Colour	€
83721	8	1,5	0,03	White	1,00
83723	8	1,5	0,03	Black	1,00



Schale „ZEN“

bowl
cuenco
bol



	cm	↑ cm	ltr.	Farbe / Colour	€
83718	12 x 12	4	0,2	White	4,20
83720	12 x 12	4	0,2	Black	4,20



Schale „ZEN“

bowl
cuenco
bol



	cm	↑ cm	ltr.	Farbe / Colour	€
83726	13 x 11	3,5	0,1	White	2,50
83728	13 x 11	3,5	0,1	Black	2,50



Schale „ZEN“

bowl
cuenco
bol



	cm	↑ cm	ltr.	Farbe / Colour	€
83730	11 x 10	3	0,04	White	2,30
83732	11 x 10	3	0,04	Black	2,30



Schale „ZEN“

bowl
cuenco
bol



	cm	↑ cm	ltr.	Farbe / Colour	€
83722	17,5 x 15,5	5,5	0,2	White	6,00
83724	17,5 x 15,5	5,5	0,2	Black	6,00



Schale „ZEN“

bowl
cuenco
bol



	cm	↑ cm	ltr.	Farbe / Colour	€
83934	14,5 x 12,5	5	0,2	■	4,60
83935	14,5 x 12,5	5	0,2	■	4,60



Schale „ZEN“

bowl
cuenco
bol



	∅ cm	↑ cm	ltr.	Farbe / Colour	€
83932	11,5	4	0,15	■	4,40
83933	11,5	4	0,15	■	4,40



Schale „ZEN“

bowl
cuenco
bol



	cm	↑ cm	ltr.	Farbe / Colour	€
83946	9 x 7	2,5	0,05	■	3,20
83947	9 x 7	2,5	0,05	■	3,20



Schale „ZEN“

bowl
cuenco
bol



	cm	↑ cm	Farbe / Colour	€
83948	14 x 9	2,5	■	3,70
83949	14 x 9	2,5	■	3,70



Tablett / Teller „ZEN“

tray / plate
bandeja / plato
plateau / assiette



	Ø cm	↑ cm	Farbe / Colour	€
83940	28	3	White	9,50
83941	28	3	Black	9,50



Tablett „ZEN“

tray
bandeja
plateau



	cm	↑ cm	Farbe / Colour	€
83734	23,5 x 23	5,5	White	8,40
83736	23,5 x 23	5,5	Black	8,40



Tablett / Sushiboard „ZEN“

tray / sushiboard
bandeja para sushi
plateau sushi



	cm	↑ cm	Farbe / Colour	€
83742	22,5 x 9,5	3	White	4,20
83744	22,5 x 9,5	3	Black	4,20



Tablett / Sushiboard „ZEN“

tray / sushiboard
bandeja para sushi
plateau sushi



	cm	↑ cm	Farbe / Colour	€
83738	22 x 12	3	White	5,60
83740	22 x 12	3	Black	5,60

FUSION



Die Oberflächen der Serie FUSION sind innen hoch glänzend und außen mattiert. Das besondere Design beansprucht höchste Aufmerksamkeit und bringt Speisen optimal zur Geltung. Die Speisen werden noch mehr in den Blickpunkt gerückt.

The surfaces of the FUSION series have a mirror shiny inside and a matte outside. The unique design demands the utmost attention. The food moves even more in the focus.

Las superficies de la serie FUSION tienen un interior brillante y un exterior mate. El diseño único exige la máxima atención. Los platos reciben un enfoque aún mayor.

Les surfaces de la série FUSION sont brillantes à l'intérieur et mates à l'extérieur. Le design spéciale exige la plus grande attention. Les plats sont mise encore plus dans le centre de l'attention.



Schale „FUSION“

bowl
cuenco
bol



	Ø cm	↑ cm	litr.	€
84022	11	7,0	0,3	5,20
84023	17	8,5	1,0	9,80
84024	20	8,0	1,2	13,80



Tablett „FUSION“

tray
bandeja
plateau



	cm	↑ cm	€
84025	23,5 x 7,5	2,0	5,20
84026	24,5 x 6,5	1,5	4,50

SINUS



Charakterstark und mit dem Anspruch an Funktionalität und Design präsentiert sich die Buffetserie SINUS. Die großzügigen Flächen für die Speisenpräsentation sind ausdrucksstark eingefasst und gewährleisten ein optimales Handling.

The SINUS buffet series is characterful and with a high standard of functionality and design. The spacious areas for the food presentation are expressively enclosed and ensure optimal handling in everyday dining.

La serie de buffet SINUS demuestra un carácter fuerte y tiene un alto nivel de funcionalidad y diseño. Las áreas espaciales para la presentación de la comida son expresivamente enmarcadas y aseguran un manejo óptimo en la gastronomía.

La série de buffet SINUS est pleine de caractère et avec un haut niveau de fonctionnalité et de design. Les zones spacieuses pour la présentation de la nourriture sont expressivement encadrées et assurent une maniabilité optimale dans la restauration.



GN Tablett „SINUS“

GN tray
GN bandeja
GN plateau



	cm	↑ cm	GN	Farbe / Colour	€
84230	53 x 32,5	2	1/1		27,50
84231	53 x 16,2	2	2/4		16,50
	cm	↑ cm	GN	Farbe / Colour	€
84260	53 x 32,5	2	1/1		27,50
84261	53 x 16,2	2	2/4		16,20



Schale „SINUS“

bowl
cuenco
bol



	cm	↑ cm	litr.	€
84229	10,5 x 10,5	4,0	0,1	3,50
84232	21,0 x 21,0	9,0	1,5	16,90
84233	25,0 x 25,0	11,0	2,4	21,80
84234	28,5 x 28,5	12,5	3,5	25,40

HALFTONE



Fingerfood Löffel „HALFTONE“

party spoon
cuchara party
cuillère party



	∅ cm	↑ cm	€
84158	5,5	7,0	3,00



Fingerfood Löffel „HALFTONE“

party spoon
cuchara party
cuillère party



	cm	↑ cm	€
84128	14,5 x 4,5	4,5	3,00



Tablett „HALFTONE“

tray
bandeja
plateau



	cm	↑ cm	€
84124	20,5 x 12,5	3	5,90
84125	24,5 x 15	3	7,20
84127	34,5 x 21,5	3	15,20



Tablett „HALFTONE“

tray
bandeja
plateau



	cm	↑ cm	€
84126	29 x 18	4	9,20



Schale „HALFTONE“

bowl
cuenco
bol



	∅ cm	↑ cm	ltr.	€
84217	8,0	4,0	0,1	3,20



Schale „HALFTONE“

bowl
cuenco
bol



	∅ cm	↑ cm	ltr.	€
84218	8,5	3,5	0,05	3,20



Schale „HALFTONE“

bowl
cuenco
bol



	cm	↑ cm	ltr.	€
84130	11,5 x 7	4	0,05	2,80
84131	14 x 8	4,5	0,10	3,50
84132	15 x 9,5	5	0,15	3,90



Schale „HALFTONE“

bowl
cuenco
bol



	cm	↑ cm	ltr.	€
84133	17,5 x 13,5	6,5	0,35	5,90
84134	24 x 17,5	7,5	0,8	10,50



Schale „HALFTONE“

bowl
cuenco
bol



	cm	↑ cm	ltr.	€
84135	16,5	7,5	0,65	8,40
84136	19	8,5	1	10,50



Schale „HALFTONE“

bowl
cuenco
bol



	cm	↑ cm	ltr.	€
84137	26	9	1,5	17,00

TAO



Schale, rund „TAO“ bowl, round cuenco, redondo bol, rond



	cm	↑ cm	ltr.	Farbe / Colour	€
83648	10,5 x 10,0	6,5 / 3,0	0,07	White	3,40
83651	13,5 x 12,5	8,5 / 4,0	0,15	White	5,00
83654	17,0 x 16,0	10,5 / 4,5	0,3	White	7,40
	cm	↑ cm	ltr.	Farbe / Colour	€
83649	10,5 x 10,0	6,5 / 3,0	0,07	Black	3,40
83652	13,5 x 12,5	8,5 / 4,0	0,15	Black	5,00
83655	17,0 x 16,0	10,5 / 4,5	0,3	Black	7,40



Schale, quadratisch „TAO“ bowl, square cuenco, cuadrado bol creux carré



	cm	↑ cm	ltr.	Farbe / Colour	€
83642	30,5 x 30,5	10	3,3	White	18,50
83643	30,5 x 30,5	10	3,3	Black	18,50



Schale, rechteckig „TAO“ bowl, rectangular cuenco, rectangular bol creux rectangulaire



	cm	↑ cm	ltr.	Farbe / Colour	€
83639	32,5 x 17,5	10	1,8	White	14,50
83640	32,5 x 17,5	10	1,8	Black	14,50

APART



GN Tablett „APART“

GN tray
GN bandeja
GN plateau



	cm	↑ cm	GN	€
83828	53,0 x 32,5	2,5	1/1	29,80
83830	32,5 x 26,5	2,5	1/2	17,00
83832	32,5 x 17,6	2,5	1/3	13,00



Tablett „APART“

tray
bandeja
plateau



	cm	↑ cm	€
83834	23,0 x 23,0	2,5	9,20
83836	33,0 x 33,0	2,5	19,00



Schale, rund „APART“

bowl, round
cuenco, redondo
bol, rond



	Ø cm	↑ cm	litr.	€
83800	6,5	3,0	0,045	1,30

Schale, eckig „APART“

bowl, square
cuenco, cuadrado
bol, carré



	cm	↑ cm	litr.	€
83808	6,6 x 6,6	3,0	0,05	1,40
83810	10 x 10	4,5	0,17	2,80
83812	15 x 15	6,5	0,5	6,80
83814	20 x 20	9,0	1,6	16,20
83816	25 x 25	9,0	2,6	22,00
83818	25 x 25	12,5	3,8	27,00
83820	30 x 30	12,5	4,5	32,00



GN 2/4 Schale „APART“

GN 2/4 bowl
GN 2/4 cuenco
GN 2/4 bol



	cm	↑ cm	GN	litr.	€
83826	53,0 x 16,2	6,5	2/4	3,0	20,00

GLOBAL BUFFET



Schale „GLOBAL BUFFET“

bowl
cuenco
bol



	cm	↑ cm	ltr.	Farbe / Colour	€
83785	32,5 x 32,5	12,0	3,0	White	21,00
83786	35,0 x 35,0	12,5	3,5	White	26,40
83787	40,0 x 40,0	13,5	5,0	White	33,90
	cm	↑ cm	ltr.	Farbe / Colour	€
84785	32,5 x 32,5	12,0	3,0	Black	21,00
84786	35,0 x 35,0	12,5	3,5	Black	26,40
84787	40,0 x 40,0	13,5	5,0	Black	34,00



Schale „GLOBAL BUFFET“

bowl
cuenco
bol



	cm	↑ cm	ltr.	Farbe / Colour	€
83799	25,5	13,0	3,0	White	17,00
83788	32,0	16,5	4,5	White	21,40
83789	35,0	17,0	6,0	White	26,40
83790	40,0	17,5	8,0	White	34,00
	cm	↑ cm	ltr.	Farbe / Colour	€
83779	25,5	13,0	3,0	Black	17,00
84788	32,0	16,5	4,5	Black	21,40
84789	35,0	17,0	6,0	Black	26,40
84790	40,0	17,5	8,0	Black	34,00



Schale „GLOBAL BUFFET“

bowl
cuenco
bol



	cm	↑ cm	ltr.	Farbe / Colour	€
83791	32 x 32	12,0	2,5	White	22,00
83792	36 x 36	12,5	4,0	White	26,40



Tablett „GLOBAL BUFFET“

tray
bandeja
plateau



	cm	↑ cm	Farbe / Colour	€
83794	30,5 x 30,5	4	White	20,00
83795	36,0 x 36,0	5	White	26,40
83796	38,5 x 29,5	5	White	26,40
83797	44,0 x 34,5	5	White	33,00



Schale „GLOBAL BUFFET“

bowl
cuenco
bol



die Melaminschale wirkt optisch wie der Naturstein Granit
the melamine trays look visually as made of natural granit stone
las bandejas de melamina parecen estar hechas de granito natural
les plateaux de mélamine donnent une impression visuelle de granit naturel

	cm	↑ cm	ltr.	Farbe / Colour	€
84387	36 x 36	11	3,5	Black	24,00



Schale „GLOBAL BUFFET“

bowl
cuenco
bol



	cm	↑ cm	ltr.	Farbe / Colour	€
84462	44 x 25	20	3,3	White	19,00



Schale „GLOBAL BUFFET“

bowl
cuenco
bol



	cm	↑ cm	ltr.	Farbe / Colour	€
84464	35,5 x 31,5	14	2,5	White	16,00
84466	46 x 40	18,5	5,5	White	29,00

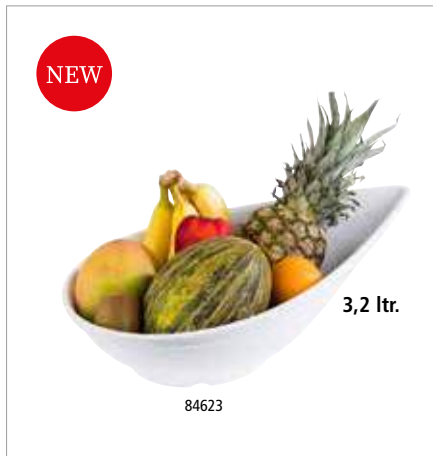

Schale „GLOBAL BUFFET“

bowl
cuenco
bol



	cm	↑ cm	ltr.	Farbe / Colour	€
84622	42 x 27	14	2,2	White	19,00
84623	50 x 32	17	3,2	White	29,00



Schale „LEAF“

bowl
cuenco
bol



	cm	↑ cm	ltr.	Farbe / Colour	€
84200	42,0 x 19,5	6,5	1,0	White	11,00
84202	50,0 x 23,0	7,5	1,5	White	16,80



Schale „BIG WAVE“

bowl
cuenco
bol



	cm	↑ cm	ltr.	Farbe / Colour	€
83587	33,0 x 24,0	8,5	1	White	18,20



Etagère „CASUAL“

etagère
expositor
présentoir



inklusive Edelstahl-Schild, beschriftbar
including stainless steel sign, inscribable
placa de acero inoxidable incluida, rotulable
étiquette en acier inox incluse, inscriptible

	Ø cm	↑ cm		€
34248	31 - 41 - 51	55	3-stufig / 3-tier 3 niveles / 3 étages	109,00
34247	31 - 41	35	2-stufig / 2-tier 2 niveles / 2 étages	66,00

FLYING BUFFET



Fingerfood-Teller „FLYING BUFFET“

fingerfood plate
plato para el aperitivo
assiette pour apéritif



	cm	↑ cm	Farbe / Colour	€
83878	9,5 x 9,5	1,5 / 3,5	White	3,20
83879	9,5 x 9,5	1,5 / 3,5	Black	3,20



Schale „FLOAT“

bowl
cuenco
bol



	cm	↑ cm	Farbe / Colour	€
83912	9,0 x 9,0	4,5	White	3,00
83913	9,0 x 9,0	4,5	Black	3,00



GN Tablett „APART“

GN tray
GN bandeja
GN plateau



	cm	↑ cm	GN	€
83828	53,0 x 32,5	2,5	1/1	29,80



GN Edelstahl Tablett „FRAMES“

GN stainless steel platter
GN bandeja de acero inoxidable
GN plateau en acier inox



	cm	GN	€
11119	53,0 x 32,5	1/1	28,00

CASCADE



Schale „CASCADE“
bowl
cuenco
bol



	cm	↑ cm	GN	ltr.	€
83963	28,5 x 25,5	7,5		2,90	17,00
83960	32,5 x 26,5	7,5	1/2	3,65	18,00
83962	26,5 x 16,2	7,5	1/4	1,50	9,80



Tablett „CASCADE“
tray
bandeja
plateau



	cm	↑ cm	GN	fits to	€
83964	28,5 x 25,5	2,4		83963	12,00
83965	32,5 x 26,5	2,4	1/2	83960	14,80
83967	26,5 x 16,2	2,4	1/4	83962	7,40



Tablett kann als Deckel eingesetzt werden!
Tray is also useable as a cover!
¡La bandeja se puede usar como tapa!
Le plat s'utilise aussi comme couvercle!

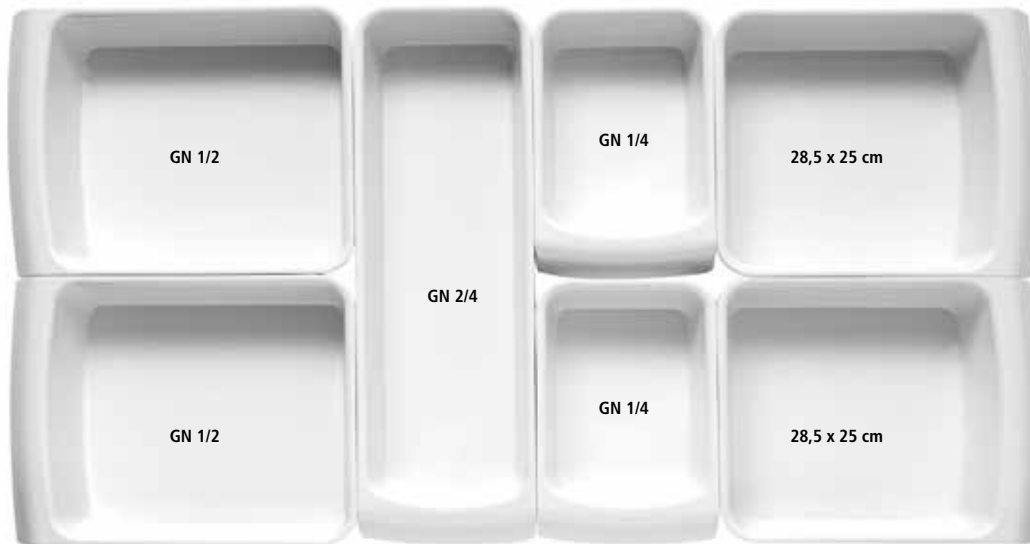

Gastronorm - Außenmaße Gastronorm - size Gastronorm - medidas exteriores Gastronorme - Gastronorme dimensions extérieures



GN 2/4 Schale „CASCADE“

GN 2/4 bowl
GN 2/4 cuenco
GN 2/4 bol



	cm	↑ cm	GN	litr.	€
83961	53,0 x 16,2	7,5	2/4	3,65	19,40



GN 2/4 Tablett „CASCADE“

GN 2/4 tray
GN 2/4 bandeja
GN 2/4 plateau



	cm	↑ cm	GN	fits to	€
83966	53,0 x 16,2	2,4	2/4	83961	16,00



- stapelbar mit Löffel und Deckel
- Schalenboden fixiert sich auf dem Deckel
- rutschfest (Antirutschfüßchen)





- with spoon and cover stackable
- non-slip feet











- con tapa apilable
- la base se fija a la tapa
- apilado estable (pies anti-deslizantes)

- avec couvercle qui permet un empilage parfait
- le pied du bol supérieur s'encadre dans le couvercle
- antidérapant



Schale „FLOAT“
bowl
cuenco
bol

	Ø cm	↑ cm	ltr.	Farbe / Colour	€
83900	5,5	3,0	0,03		1,50
83902	9,0	4,5	0,15		2,60
83904	13,0	6,5	0,45		6,30
83906	15,0	7,5	0,70		9,20
83908	20,5	10,0	1,90		15,80
<hr/>					
	Ø cm	↑ cm	ltr.	Farbe / Colour	€
83901	5,5	3,0	0,03		1,50
83903	9,0	4,5	0,15		2,60
83905	13,0	6,5	0,45		6,30
83907	15,0	7,5	0,70		9,20
83909	20,5	10,0	1,90		15,80



Schale „FLOAT“

bowl
cuenco
bol



	cm	↑ cm	ltr.	Farbe / Colour	€
83910	5,5 x 5,5	3,0	0,03	White	1,50
83912	9,0 x 9,0	4,5	0,16	White	3,00
83914	12,5 x 12,5	6,0	0,50	White	6,00
83916	19 x 19	9,5	1,90	White	14,20
83918	25 x 25	12,0	4,70	White	26,00
	cm	↑ cm	ltr.	Farbe / Colour	€
83911	5,5 x 5,5	3,0	0,03	Black	1,50
83913	9,0 x 9,0	4,5	0,16	Black	3,00
83915	12,5 x 12,5	6,0	0,50	Black	6,00
83917	19 x 19	9,5	1,90	Black	14,20
83919	25 x 25	12,0	4,70	Black	26,00



GN Tablett „FLOAT“

GN tray
GN bandeja
GN plateau



	cm	↑ cm	GN	Farbe / Colour	€
83923	53,0 x 32,5	3	1/1	White	33,00
83925	32,5 x 26,5	3	1/2	White	20,00
	cm	↑ cm	GN	Farbe / Colour	€
83924	53,0 x 32,5	3	1/1	Black	33,00
83926	32,5 x 26,5	3	1/2	Black	20,00



Deckel „FLOAT“ mit Löffelaussparung

cover, with notched for spoons
tapa, con espacio para la cuchara
couvrele, avec encoche pour la louche



	Ø cm	↑ cm	fits to	€
83920	20,5	1,3	83908, 83909	8,20



Deckel „FLOAT“ mit Löffelaussparung

cover, with notched for spoons
tapa, con espacio para la cuchara
couvrele, avec encoche pour la louche



	cm	↑ cm	fits to	€
83921	19 x 19	1,3	83916, 83917	8,20
83922	25 x 25	1,3	83918, 83919	10,40

PURE



Tablett „PURE“

tray
bandeja
plateau



	cm	↑ cm	GN	Farbe / Colour	€
83401	53,0 x 32,5	3	1/1	White	36,50
83588	35,4 x 32,5	3	2/3	White	26,80
83433	53,0 x 16,2	3	2/4	White	21,00
83480	32,5 x 26,5	3	1/2	White	19,00
83481	32,5 x 17,6	3	1/3	White	14,20
83482	26,5 x 16,2	3	1/4	White	10,50
83882	65,0 x 26,5	3		White	39,00
83597	40 x 30	3	Bäcker-Maß	White	26,80
83598	60 x 20	3	Bäcker-Maß	White	26,80
83599	60 x 40	3	Bäcker-Maß	White	55,00

	cm	↑ cm	GN	Farbe / Colour	€
83479	53,0 x 32,5	3	1/1	Black	36,50
83589	35,4 x 32,5	3	2/3	Black	26,80
83434	53,0 x 16,2	3	2/4	Black	21,00
83490	32,5 x 26,5	3	1/2	Black	19,00
83491	32,5 x 17,6	3	1/3	Black	14,20
83492	26,5 x 16,2	3	1/4	Black	10,50
83592	40 x 30	3	Bäcker-Maß	Black	26,80
83593	60 x 20	3	Bäcker-Maß	Black	26,80
83594	60 x 40	3	Bäcker-Maß	Black	55,00



Tablett „PURE“

tray
bandeja
plateau



	cm	↑ cm	Farbe / Colour	€
83625	31,0 x 10,5	2		9,00
83403	35,5 x 18,0	3		12,00
83417	30,0 x 21,0	3		13,80
83402	53,0 x 18,0	3		23,80
	cm	↑ cm	Farbe / Colour	€
83626	31,0 x 10,5	2		9,00
83483	53,0 x 18,0	3		23,50

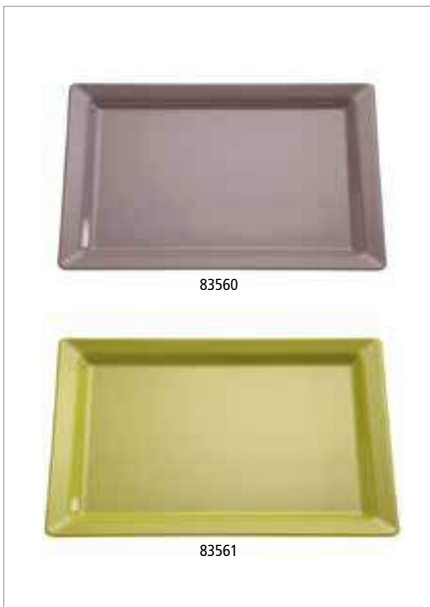

Tablett „PURE COLOR“

tray
bandeja
plateau



	cm	↑ cm	GN	Farbe / Colour	€
83560	53,0 x 32,5	3	1/1		36,50
83562	32,5 x 26,5	3	1/2		19,00
83564	53,0 x 18,0	3			23,50
83566	35,5 x 18,0	3			12,00
83561	53,0 x 32,5	3	1/1		36,50
83563	32,5 x 26,5	3	1/2		19,00
83565	53,0 x 18,0	3			23,50
83567	35,5 x 18,0	3			12,00



Tablett quadratisch „PURE“

tray square
bandeja cuadrada
plateau carré



	cm	↑ cm	Farbe / Colour	€
83418	18,0 x 18,0	3		6,90
83407	21,0 x 21,0	3		9,60
83406	26,5 x 26,5	3		14,80
83405	37,0 x 37,0	3		19,50
83404	51,0 x 51,0	3		41,50
	cm	↑ cm	Farbe / Colour	€
83400	51,0 x 51,0	3		41,00



Tablett / Teller „PURE“

tray / plate
bandeja / plato
plateau / assiette



	Ø cm	↑ cm	Farbe / Colour	€
83884	31	2,5		17,80
83869	38	2,5		20,00
83886	41	2,5		22,40
83484	51	2,5		26,50

Buffet & Tableware Melamin



Schale „PURE“

bowl
cuenco
bol



	Ø cm	↑ cm	ltr.	Farbe / Colour	€
83450	5,5	4,0	0,02	White	1,60
83419	9,0	4,5	0,09	White	2,90
83453	13,0	6,5	0,30	White	6,30
83455	15,0	7,5	0,45	White	9,90
83415	20,0	10,5	1,25	White	17,80
	Ø cm	↑ cm	ltr.	Farbe / Colour	€
83451	5,5	4,0	0,02	Black	1,60
83452	9,0	4,5	0,09	Black	2,90
83454	13,0	6,5	0,30	Black	6,30
83456	15,0	7,5	0,45	Black	9,90
83457	20,0	10,5	1,25	Black	17,80



Schale „PURE COLOR“

bowl
cuenco
bol



	cm	↑ cm	ltr.	Farbe / Colour	€
84424	6,5 x 6,5	3,0	0,05	White	2,10
83414	9,0 x 9,0	4,0	0,14	White	3,40
83410	12,5 x 12,5	6,5	0,40	White	5,60
83409	19,0 x 19,0	9,0	1,50	White	18,60
83408	25,0 x 25,0	12,0	3,80	White	30,00
84425	32,0 x 32,0	14,0	8,0	White	36,00
	cm	↑ cm	ltr.	Farbe / Colour	€
84426	6,5 x 6,5	3,0	0,05	Black	2,10
83466	9,0 x 9,0	4,0	0,14	Black	3,40
83467	12,5 x 12,5	6,5	0,40	Black	5,60
83468	19,0 x 19,0	9,0	1,50	Black	18,60
83469	25,0 x 25,0	12,0	3,80	Black	30,00
84427	32,0 x 32,0	14,0	8,0	Black	36,00
	cm	↑ cm	ltr.	Farbe / Colour	€
83568	9,0 x 9,0	4,0	0,14	Brown	3,40
83570	12,5 x 12,5	6,5	0,40	Brown	5,60
83572	19,0 x 19,0	9,0	1,50	Brown	18,60
83574	25,0 x 25,0	12,0	3,80	Brown	30,00
	cm	↑ cm	ltr.	Farbe / Colour	€
83569	9,0 x 9,0	4,0	0,14	Yellow-green	3,40
83571	12,5 x 12,5	6,5	0,40	Yellow-green	5,60
83573	19,0 x 19,0	9,0	1,50	Yellow-green	18,60
83575	25,0 x 25,0	12,0	3,80	Yellow-green	30,00



Schale „PURE BICOLOR“

bowl
cuenco
bol



	cm	↑ cm	ltr.	Farbe / Colour	€
84414	9,0 x 9,0	4,0	0,14	■ ■	3,70
84410	12,5 x 12,5	6,5	0,40	■ ■	6,30
84409	19,0 x 19,0	9,0	1,50	■ ■	20,50
84408	25,0 x 25,0	12,0	3,80	■ ■	31,80

	cm	↑ cm	ltr.	Farbe / Colour	€
84420	9,0 x 9,0	4,0	0,14	■ ■	3,70
84421	12,5 x 12,5	6,5	0,40	■ ■	6,30
84422	19,0 x 19,0	9,0	1,50	■ ■	20,50
84423	25,0 x 25,0	12,0	3,80	■ ■	32,50

	cm	↑ cm	ltr.	Farbe / Colour	€
84415	9,0 x 9,0	4,0	0,14	■ ■	3,70
84416	12,5 x 12,5	6,5	0,40	■ ■	6,30
84417	19,0 x 19,0	9,0	1,50	■ ■	20,50
84418	25,0 x 25,0	12,0	3,80	■ ■	31,80



Schale „SLATE“

bowl
cuenco
bol



	cm	↑ cm	ltr.	€
84244	19,0 x 19,0	9	1,5	20,00
84245	25,0 x 25,0	12	3,8	34,00

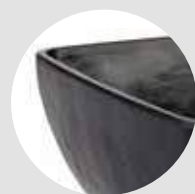

1:1 Oberflächenansicht
1:1 structural view



Deckel „PURE“ mit Löffelaussparung

cover with notched for spoons
tapa con espacio para la cuchara
couvre-cle avec encoche pour la louche



	cm	↑ cm	fits to	€
83600	19 x 19	1,5	84409, 84417, 84422, 83409, 83468, 83572, 83573	8,00
83601	25 x 25	1,5	84408, 84418, 84423, 84430, 83575, 83574, 83469, 83408	10,50
83602	32 x 32	1,5	84425, 84427	12,00

Buffet & Tableware Melamin



Schale „PURE“

bowl
cuenco
bol



	cm	↑ cm	ltr.	€
83497	22,5 x 15,5	7,5	0,80	17,40
83498	38,5 x 15,5	7,5	1,50	28,50
83499	51,0 x 15,5	7,5	2,40	37,50



GN Tablett „PURE GRANIT“

GN tray
GN bandeja
GN plateau



	cm	↑ cm	GN	€
84440	53,0 x 32,5	3	1/1	38,00
84441	32,5 x 26,5	3	1/2	19,50



Schale „PURE GRANIT“

bowl
cuenco
bol



	cm	↑ cm	ltr.	€
84429	19 x 19	9	1,50	19,00
84430	25 x 25	12	3,80	30,00



Menage „PURE“

menage
conjunto aperitivo
set apéritif



4-teilig: 1 Ständer, Edeltahl matt poliert + 3 Melamin-Schalen, weiß (Nr. 83419)

4 pcs. set: 1 stainless stand satin polished finish + 3 white bowls (No. 83419)

set de 4: 1 soporte, acero inoxidable pulido mate + 3 cuencos de melamina blancos (ref. 83419)

set de 4: 1 support, acier inox poli mat + 3 bols de mélamine blancs (ref. 83419)

	cm	↑ cm	€
09924	14 x 14	16	23,00



Menage „PURE“

menage
conjunto aperitivo
set apéritif



5-teilig: 1 Ständer, Edeltahl matt poliert + 4 Melamin-Schalen, weiß (Nr. 83414)

5 pcs. set: 1 stainless stand satin polished finish + 4 square white bowls (No. 83414)

set de 5: 1 soporte, acero inoxidable pulido mate + 4 cuencos de melamina blancos (ref. 83414)

set de 5: 1 support, acier inox poli mat + 4 bols de mélamine blancs (ref. 83414)

	cm	↑ cm	€
09923	17 x 17	16	26,00



30120

30122

Tablett „PURE“

tray
bandeja
plateau



Edelstahl matt poliert, passend für Melamin-Schalen
stainless steel satin polished finish, for melamin bowls
acero inoxidable pulido mate, apta para cuencos de melamina
acier inox poli mat, pour bols de mélamine

	cm		€
30120	20 x 11	für 2 Schalen / for 2 bowls para 2 cuencos / pour 2 bols	6,40
30122	20 x 20	für 4 Schalen / for 4 bowls para 4 cuencos / pour 4 bols	10,50
30121	29 x 20	für 6 Schalen / for 6 bowls para 6 cuencos / pour 6 bols	13,20

Schale „PURE COLOR“ / bowl / cuenco / bol

	cm	↑ cm	ltr.	Farbe / Colour	€
83414	9,0 x 9,0	4,0	0,14		3,40
83466	9,0 x 9,0	4,0	0,14		3,40
83568	9,0 x 9,0	4,0	0,14		3,40
83569	9,0 x 9,0	4,0	0,14		3,40

Schale „PURE BICOLOR“ / bowl / cuenco / bol

	cm	↑ cm	ltr.	Farbe / Colour	€
84414	9,0 x 9,0	4,0	0,14		3,70
84415	9,0 x 9,0	4,0	0,14		3,70
84420	9,0 x 9,0	4,0	0,14		3,70



84046
GN 1/1

GN Tablett „FRAMES“

GN tray
GN bandeja
GN plateau



	cm	↑ cm	GN	€
84046	53,0 x 32,5	2	1/1	26,00
84047	32,5 x 26,5	2	1/2	14,20
84048	32,5 x 17,6	2	1/3	10,00



83412

83411

Schale / Pastateller „PURE“

bowl / pasta plate
cuenco / plato para pasta
bol / assiette creuse



	Ø cm	↑ cm	ltr.	Farbe / Colour	€
83412	32,0	7,5	1,5		16,20
83411	45,5	9,0	1,7		45,50

NATURAL COLLECTION

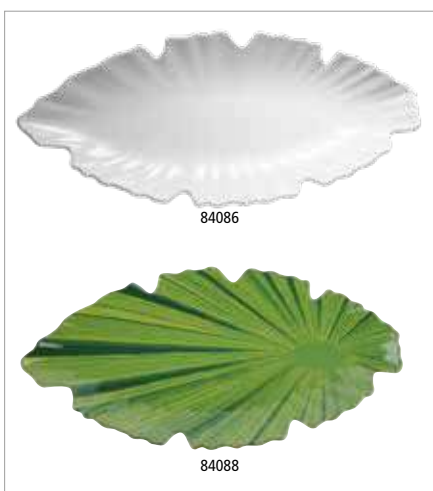

Blattschale „NATURAL COLLECTION“

leaf
fuente en forma de hoja
plateau feuille



	cm	↑ cm	Farbe / Colour	€
84083	40 x 18,5	3,5	White	14,80
84086	52 x 25,0	4,0	White	18,40
	cm	↑ cm	Farbe / Colour	€
84085	40 x 18,5	3,5	Green	14,80
84088	52 x 25,0	4,0	Green	18,40



Palmblattschale „NATURAL COLLECTION“

palm leaf
fuente en forma de hoja de palmera
plateau feuille de palme



	cm	↑ cm	ltr.	Farbe / Colour	€
84080	40 x 18,5	10	1,8	White	23,00
84082	40 x 18,5	10	1,8	Green	23,00



stapelbar, mit Löffelablage
stackable, for spoons
apilable, práctico para cubiertos de servicio
empilable, pratique pour déposer les couverts



Blattschale „NATURAL COLLECTION“

leaf
fuente en forma de hoja
plateau feuille



	cm	↑ cm	Farbe / Colour	€
83864	34,5 x 8	2,5	White	9,50
83862	34,5 x 8	2,5	Green	9,50



Tablett „PINEAPPLE“

tray
bandeja
plateau



	cm	↑ cm	Farbe / Colour	€
84624	30 x 17	2,5	White	4,90



Palmblattschale „NATURAL COLLECTION“

palm leaf
fuente en forma de hoja de palmera
plateau feuille de palme



	Ø cm	↑ cm	ltr.	Farbe / Colour	€
83447	30	10,0	1,5	White	16,00
83896	35	12,5	4,5	White	35,70
	Ø cm	↑ cm	ltr.	Farbe / Colour	€
83449	30	10,0	1,5	Green	16,00
83894	35	12,5	4,5	Green	35,70



Blattschale „NATURAL COLLECTION“

leaf
fuente en forma de hoja
plateau feuille



	cm	↑ cm	Farbe / Colour	€
83435	36 x 16	3,0	White	12,00
83438	45 x 24	3,0	White	16,00
83441	53 x 29	3,5	White	18,40
	cm	↑ cm	Farbe / Colour	€
83437	36 x 16	3,0	Green	12,00
83440	45 x 24	3,0	Green	16,00
83443	53 x 29	3,5	Green	18,40



Palmblattschale „NATURAL COLLECTION“

palm leaf
fuente en forma de hoja de palmera
plateau feuille de palme



	cm	↑ cm	Farbe / Colour	€
83865	27 x 27	4,5	Green	14,80
83446	35 x 34	4,5	Green	18,40
83866	42 x 42	4,5	Green	28,40



Schale, oval „CLASSIC WAVE“

owl, oval
cuenco, ovalada
plateau ovale



	cm	↑ cm	ltr.	Farbe / Colour	€
83875	27 x 17	4,0	0,80	White	12,00
83876	34 x 21	4,5	1,30	White	15,50
83877	47 x 29	5,0	3,20	White	23,80



Buffet & Tableware Melamin

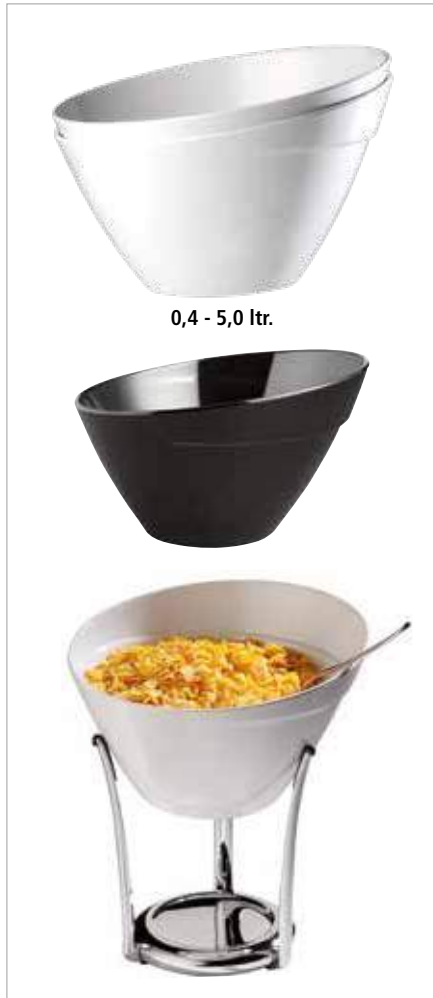

0,4 - 5,0 ltr.

Schale „BALANCE“

bowl
cuenco
bol



	Ø cm	↑ cm	ltr.	Farbe / Colour	€
84040	14,5	9,0	0,4	White	5,20
84041	21,0	13,0	1,5	White	11,50
84042	24,5	15,0	2,5	White	15,00
84043	30,0	19,5	5,0	White	25,00

	Ø cm	↑ cm	ltr.	Farbe / Colour	€
85040	14,5	9,0	0,4	Black	5,20
85041	21,0	13,0	1,5	Black	11,50
85042	24,5	15,0	2,5	Black	15,00
85043	30,0	19,5	5,0	Black	25,00

Buffetständer „KING“ / buffet stand / soporte para buffet / présentoir buffet

	Ø cm	↑ cm	€
03622	15	14	36,00
03623	15	21	39,60



Schale „PURE“

bowl
cuenco
bol



weiße Schale mit blauem Rand, hochglänzend, klassischer Emaille-Look
white bowl with a blue edge, mirror polished finished, classic enamel look
cuenco blanco con borde azul, pulido brillante, estilo esmalte clásico
bol blanc avec bord bleu, brillant, émail look classique

	Ø cm	↑ cm	ltr.	€
84490	5,5	4,0	0,02	1,70
84491	9,5	4,5	0,09	3,00
84492	13	6,5	0,30	6,60
84493	15	7,5	0,45	10,40
84494	20	10,5	1,25	19,00

CASUAL



Schälchen „CASUAL MINI“

bowl
cuenco
bol mini



	cm	↑ cm	ltr.	Farbe / Colour	€
83880	6,0	2,5	0,02	White	1,60
83881	7,5	3,5	0,05	White	2,00



Schale „CASUAL MAXI“

bowl
cuenco
bol



	Ø cm	↑ cm	ltr.	Farbe / Colour	€
83696	10	4,5	0,15	White	2,60
83698	12	5,5	0,25	White	3,20
83700	14	6,5	0,50	White	3,80
83704	20	9,2	1,80	White	7,90
83702	23	10,5	2,50	White	9,00

	Ø cm	↑ cm	ltr.	Farbe / Colour	€
83697	10	4,5	0,15	Black	2,60
83699	12	5,5	0,25	Black	3,20
83701	14	6,5	0,50	Black	3,80
83705	20	9,2	1,80	Black	7,90
83703	23	10,5	2,50	Black	9,00

Deckel „FLOAT“ mit Löffelaussparung / cover, with notched for spoons / tapa, con espacio para la cuchara / couvercle, avec encoche pour la louche

	Ø cm	↑ cm	fits to	€
83920	20,5	1,3	83704, 83705	8,20



Dip-Schälchen „CASUAL“

dip bowl
cuenco para dip
ramequin



	Ø cm	↑ cm	ltr.	Farbe / Colour	€
83780	6,0	3,7	0,04	White	0,80
83781	7,0	3,7	0,05	White	1,10
83782	7,8	4,0	0,08	White	1,40
83783	8,5	4,5	0,11	White	1,50
83784	9,8	4,5	0,14	White	1,80
83798	6,0	3,7	0,04	Black	1,00
83777	6,0	3,5	0,03	Terracotta	1,00

Buffet & Tableware Melamin



Schale „SCANTIC“

bowl
cuenco
bol



	cm	↑ cm	ltr.		€
84221	26,5 x 10,5	6,5	1,0		9,60
84222	53,0 x 10,5	6,5	2,0		18,20



Schale „ORGANIC“

bowl
cuenco
bol



	cm	↑ cm	ltr.	Farbe / Colour	€
84235	32,5 x 17	5,5	1,0	White	8,60
84236	50,0 x 26	6,5	3,5	White	24,00
84237	32,5 x 17	5,5	1,0	Black	8,60
84238	50,0 x 26	6,5	3,5	Black	24,00



Schale „CASUAL“

bowl
cuenco
bol



	Ø cm	↑ cm	ltr.		€
84215	10	6,5 / 8,5	0,2		4,80
84216	12	7,5 / 9,5	0,3		6,20



Schale „TIERRA“

bowl
cuenco
bol



	Ø cm	↑ cm	ltr.	Farbe / Colour	€
84295	10	7	0,13	White	2,70



Dipschale „CASUAL“

dip tray
bandeja para dips
plateau pour dips



	cm	↑ cm		€
84220	29,0 x 9,0	3,0		6,60



Torten- / Konditorplatte

cake stand
soporte para pastel
présentoir à gâteaux

Rand fixiert die Haube, mit Antirutsch-Füßchen

carved edge fixes the cover, with non-slip feet

ranura para fijar bien la campana, con pies antideslizantes

bord rainuré pour maintenir ferme la cloche, avec pieds antidérapants



06520
page 510

00468

	Ø cm	↑ cm	Farbe / Colour	€
00468	31	4		15,00
00469	31	4		15,00



Frischhalte-Haube

cover
campana
cloche



	Ø cm	↑ cm		€
06510	30	11,5		4,40
06512	30	11,5	mit verchromtem Griff / with chrom plated handle con botón cromado / avec bouton chromé	5,90



Tablett / Teller „PURE“

tray / plate
bandeja / plato
plateau / assiette



	Ø cm	↑ cm	Farbe / Colour	€
83869	38	2,5		20,00

Rolltophaube / rolltop cover / campana abatible / cloche basculante

	Ø cm	↑ cm		€
18388	38	20	mit verchromtem Kugelgriff / with chrome plated handle con pomo cromado / avec bouton chromé	19,40



Servier- und Tortenplatte „CASUAL“

cake plate
porta pasteles
présentoir à gâteaux



	Ø cm	↑ cm		€
83890	31	8		24,00
83891	31	16		30,00



Servier- und Tortenplatte „CASUAL“

cake plate
porta pasteles
présentoir à gâteaux



	cm	↑ cm		€
83892	31 x 31	8		27,00
83893	31 x 31	16		32,50

FINGERFOOD LÖFFEL



Fingerfood Löffel „HALFTONE“

party spoon
cuchara party
cuillère party



	Ø cm	↑ cm	Farbe / Colour	€
84158	5,5	7,0	■ ■	3,00



Fingerfood Löffel „HALFTONE“

party spoon
cuchara party
cuillère party



	cm	↑ cm	Farbe / Colour	€
84128	14,5 x 4,5	4,5	■ ■	3,00



Fingerfood Löffel „BOAT“

party spoon
cuchara party
cuillère party



	cm	↑ cm	Farbe / Colour	€
84140	14,5 x 4,5	4,5	■ ■	2,90
84141	14,5 x 4,5	4,5	■ ■	2,90
84142	14,5 x 4,5	4,5	■ ■	2,90
84143	14,5 x 4,5	4,5	■ ■	2,90



Fingerfood Löffel „HONG KONG“

party spoon
cuchara party
cuillère party



	cm	↑ cm	Farbe / Colour	€
83486	13 x 4,5	4,5		1,20
83487	13 x 4,5	4,5		1,20
83424	13 x 4,5	4,5		1,20
83426	13 x 4,5	4,5		1,20



Fingerfood-Löffel „MING HING“

party spoon
cuchara party
cuillère party



	cm	↑ cm	Farbe / Colour	€
83842	11 x 4,5	4		1,10
83843	11 x 4,5	4		1,10



Fingerfood-Löffel „YING YANG“

party spoon
cuchara party
cuillère party



	cm	↑ cm	Farbe / Colour	€
83844	10 x 4,5	1,5		1,10
83845	10 x 4,5	1,5		1,10



Fingerfood-Löffel „LEAF“

party spoon
cuchara party
cuillère party



	cm	↑ cm	Farbe / Colour	€
83889	10 x 4,5	1,5		1,80
83887	10 x 4,5	1,5		1,80
83888	10 x 4,5	1,5		1,80



NEW MINI



NEW

84625

84626

84627

Schale „MINI COLOUR“

bowl
cuenco
bol



	cm	↑ cm	litr.	Farbe / Colour	€
84625	12,5 x 9,0	3,5	0,02		2,90
84626	12,5 x 9,0	3,5	0,02		2,90
84627	12,5 x 9,0	3,5	0,02		2,90

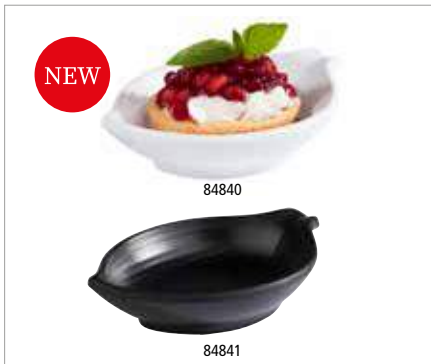

NEW

84840

84841

Schale „MINI LEAF“

bowl
cuenco
bol



	cm	↑ cm	litr.	Farbe / Colour	€
84840	10,5 x 7,5	2,5	0,04		2,00
84841	10,5 x 7,5	2,5	0,04		2,00



NEW

84842

84843

Schale „MINI LEAF“

bowl
cuenco
bol



	cm	↑ cm	litr.	Farbe / Colour	€
84842	10,5 x 6,5	4,5	0,06		2,00
84843	10,5 x 6,5	4,5	0,06		2,00

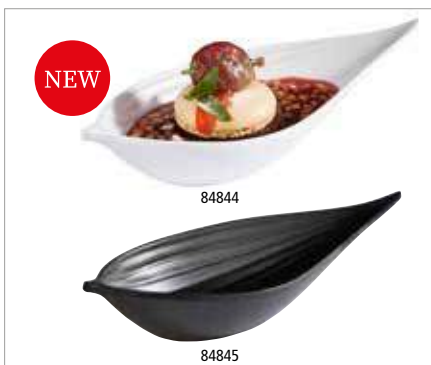

NEW

84844

84845

Schale „MINI LEAF“

bowl
cuenco
bol



	cm	↑ cm	litr.	Farbe / Colour	€
84844	14,5 x 6,0	3,0	0,05		2,20
84845	14,5 x 6,0	3,0	0,05		2,20



Schale „MINI“

bowl
cuenco
bol



	cm	↑ cm	ltr.	Farbe / Colour	€
84750	8,0 x 8,0	3,0	0,06		2,80
84755	8,0 x 8,0	3,0	0,06		2,80
84760	8,0 x 8,0	3,0	0,06		2,80



Schale „MINI“

bowl
cuenco
bol



	cm	↑ cm	ltr.	Farbe / Colour	€
84751	9,5 x 9,5	3,0	0,1		3,00
84756	9,5 x 9,5	3,0	0,1		3,00
84761	9,5 x 9,5	3,0	0,1		3,00



Schale „MINI“

bowl
cuenco
bol



	cm	↑ cm	ltr.	Farbe / Colour	€
84752	9,5 x 8,0	3,0	0,08		2,90
84757	9,5 x 8,0	3,0	0,08		2,90
84762	9,5 x 8,0	3,0	0,08		2,90



Schale / Schiffchen „MINI“

bowl
cuenco
bol



	cm	↑ cm	ltr.	Farbe / Colour	€
84753	12,5 x 5,5	4,0	0,06		2,90
84758	12,5 x 5,5	4,0	0,06		2,90
84763	12,5 x 5,5	4,0	0,06		2,90



Schale / Schiffchen „MINI“

bowl
cuenco
bol



	cm	↑ cm	ltr.	Farbe / Colour	€
84754	14,0 x 6,5	4,0	0,1		3,20
84759	14,0 x 6,5	4,0	0,1		3,20
84764	14,0 x 6,5	4,0	0,1		3,20

Buffet & Tableware Melamin



Teller „MINI“

plate
plato
assiette



	cm	↑ cm	ltr.	€
84444	10,5 x 8,5	2,0	0,07	3,00



Schale „MINI“

bowl
cuenco
bol



	cm	↑ cm	ltr.	€
84445	10,5 x 6,0	4,0	0,07	3,00
84446	13,5 x 7,5	3,0	0,07	3,00
84448	9,5 x 9,0	5,5	0,09	3,00
84449	13,0 x 12,0	7,5	0,18	4,00



Schale „MINI“

bowl
cuenco
bol



	Ø cm	↑ cm	ltr.	Farbe / Colour	€
84775	8,5	2,5	0,07	White	2,60
84778	8,5	2,5	0,07	Black	2,60
84781	8,5	2,5	0,07	Grey	2,60



Schale „MINI“

bowl
cuenco
bol



	Ø cm	↑ cm	ltr.	Farbe / Colour	€
84776	8,5	2,5	0,07	White	2,60
84779	8,5	2,5	0,07	Black	2,60
84782	8,5	2,5	0,07	Grey	2,60



Schale „MINI“

bowl
cuenco
bol



	cm	↑ cm	ltr.	Farbe / Colour	€
84777	9,5 x 5,5	5,5	0,07	White	2,60
84780	9,5 x 5,5	5,5	0,07	Black	2,60
84783	9,5 x 5,5	5,5	0,07	Grey	2,60



Schale „MINI“

bowl
cuenco
bol



	cm	↑ cm	ltr.	€
84460	35,0 x 4,5	3	0,20	2,60

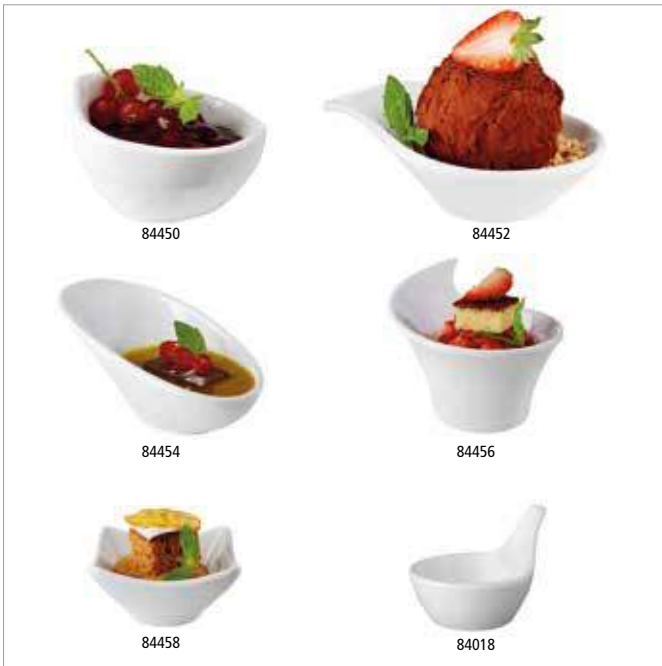

Schale „MINI“

bowl
cuenco
bol



	cm	↑ cm	ltr.	€
84452	11,5 x 7,5	3	0,06	1,60
84454	11,5 x 6,0	5,5	0,04	1,60
84456	8,5 x 7,0	6	0,07	1,60
84458	8,0 x 8,0	4	0,10	1,60
84450	7,5 x 7,0	4,5	0,05	1,60

Schälchen „GOURMET“ / bowl / cuenco / bol

	Ø cm	↑ cm	ltr.	€
84018	7	6	0,05	2,00



Schale „HALFTONE“

bowl
cuenco
bol



	Ø cm	↑ cm	ltr.	€
84217	8,0	4,0	0,1	3,20
84218	8,5	3,5	0,05	3,20

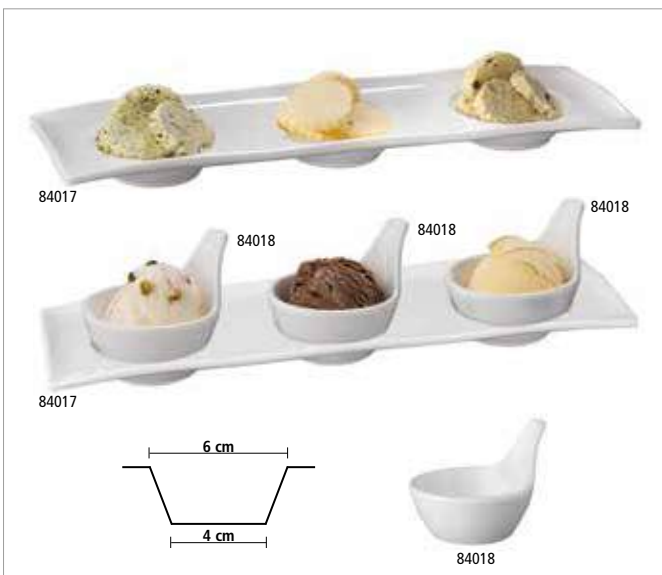

Tablett „GOURMET“

tray
bandeja
plateau



mit 3 Absätzen Ø 4 cm
with 3 holes Ø 4 cm
con 3 agujeros Ø 4 cm
avec 3 trous Ø 4 cm

	cm	↑ cm	€
84017	30,5 x 9,5	2,5	7,60

Schälchen „GOURMET“ / bowl / cuenco / bol

	Ø cm	↑ cm	ltr.	€
84018	7	6	0,05	2,00

Buffet & Tableware Melamin



Löffel „GREEN BAMBOO“

spoon
cuchara
cuillère



	cm	→ cm	ltr.	€
84648	6 x 4,5	20	0,01	2,00
	Ø cm	→ cm	ltr.	€
84649	6	21	0,02	2,40



Besteckablage „SPOON“

cutlery rest
reposa cuchara
pose-cuillère



	cm	↑ cm	€
83801	26 x 10,5	5	6,00



Besteckablage „BOWL“

cutlery rest
reposa cuchara
pose-cuillère



	cm	↑ cm	ltr.	€
83803	22,5 x 11	6	0,5	6,40



Besteckablage „SMALL WAVE“

cutlery rest
reposa cuchara
pose-cuillère



	cm	↑ cm	€
83897	26 x 13	4,5	8,90



Salat-Löffel

salad spoon
cuchara para ensalada
cuillère à salade



	cm	↑ cm	€
84035	24 x 7	4,5	2,40



Servierlöffel „PROFI“

serving spoon
cuchara para servir
cuillère de service



	cm	→ cm	Farbe / Colour	€
84020	7 x 6,5	26,5		5,40
84021	7 x 6,5	26,5		5,40



Teller mit Glashalter „COCKTAIL“

plate with glass holder
plato sujeta copas
assiette porte-verre



eignet sich besonders für Stehempfänge, einhändig nutzbar
particularly suitable for standing receptions, single-handed use
para uso en recepciones de pie, facil de usar con sólo una mano
particulièrement pour des receptions debout, utilisable avec une seule main

	→ cm	↑ cm	€
84620	22 x 14	1,5	3,00



	Ø cm	↑ cm	€
84621	19	1,5	3,00



Teller, rund „CASUAL“

plate, round
plato, redondo
assiette, ronde



	Ø cm	↑ cm	€
83500	22,5	2,5	7,00
83514	26,5	2,5	8,40



Kaffeebecher „CASUAL“

coffee cup
taza de café
tasse à café



	Ø cm	↑ cm	ltr.	€
83513	9,5	10	0,4	5,90



Eierbecher, 4er Set

egg holder, 4 pcs. set
huevera, set de 4
coquetier, set de 4



	Ø cm	↑ cm	pcs.	€
83851	8	3	4	6,40
83848	8,5	2	4	5,90





Tableware

Table Presentation

Tableware
Table Presentation

Schalen
Teller
Mühlen
Leuchter
Tischsets

cuencos
bandejas
molinillos
candelabros
mantelines

bowls
trays
mills
candle holders
placemats

bols
plateaux
moulins
chandeliers
sets de table

SNACKHOLDER



Die Mini-Edestahlkörbchen dienen dem portionsweisen Servieren. Zum originellen Servieren von Beilagen geeignet, aber auch zum Frittieren selbst.

The mini frying baskets are used to present individual portions in an original way, but can still be used to fry.

Las cestas de freir ofrecen una presentación original para el servicio de tapas o raciones individuales de patatas, aperitivos, fritos, etc.

Les paniers à friture offrent une présentation originale pour servir apéritifs, snacks, tapas et autres rations individuelles. Également aptes pour frire.



Servier-Frittierkorb „SNACKHOLDER“

stainless steel fry baskets
cestitas inox para el servicio mesa
paniers inox pour le service sur table



	Ø cm	↑ cm	Griff	€
40600	8	7,5	9,5	8,00
40601	9	8,5	9,0	9,80



Servier-Frittierkorb „SNACKHOLDER“

stainless steel fry baskets
cestitas inox para el servicio mesa
paniers inox pour le service sur table



	cm	↑ cm	Griff	€
40610	21,5 x 10,5	4,5	9,5	13,60
40611	26,0 x 13,0	5,0	9,0	16,00



Servier-Frittierkorb „SNACKHOLDER“

stainless steel fry baskets
cestitas inox para el servicio mesa
paniers inox pour le service sur table



	cm	↑ cm	Griff	€
40620	10,0 x 8,5	6,5	9,0	11,20
40621	13,0 x 10,5	9,0	13,5	14,50

SNACKHOLDER



Made from PVD coated stainless steel

Die Mini-Edestahlkörbchen dienen dem portionsweisen Servieren. Zum originellen Servieren von Beilagen geeignet, aber auch zum Frittieren selbst.

The mini frying baskets are used to present individual portions in an original way, but can still be used to fry.

Las cestas de freir ofrecen una presentación original para el servicio de tapas o raciones individuales de patatas, aperitivos, fritos, etc.

Les paniers à friture offrent une présentation originale pour servir apéritifs, snacks, tapas et autres rations individuelles. Également aptes pour frire.



40602

Servier-Frittierkorb „SNACKHOLDER“

stainless steel fry baskets
cestitas inox para el servicio mesa
paniers inox pour le service sur table



	Ø cm	↑ cm	Griff	Farbe / Colour	€
40602	8	7,5	9,5		10,50
40603	9	8,5	9,0		11,90



40613

Servier-Frittierkorb „SNACKHOLDER“

stainless steel fry baskets
cestitas inox para el servicio mesa
paniers inox pour le service sur table



	cm	↑ cm	Griff	Farbe / Colour	€
40612	21,5 x 10,5	4,5	9,5		16,00
40613	26,0 x 13,0	5	9,5		18,60



40622

Servier-Frittierkorb „SNACKHOLDER“

stainless steel fry baskets
cestitas inox para el servicio mesa
paniers inox pour le service sur table



	cm	↑ cm	Griff	Farbe / Colour	€
40622	10,0 x 8,5	6,5	9,0		14,50
40623	13,0 x 10,5	9,0	13,5		17,90

Tableware . Table Presentation



Snackholder

serving cup
vaso para servir
gobelet à apéritif



Edelstahl, außen verkupfert

stainless steel, outside copper coated
acero inoxidable, el exterior está cubierto de cobre
acier inoxydable, l'extérieur est cuivré

	Ø cm	↑ cm	ltr.	Farbe / Colour		€
40616	9,5	8,5 / 11,5	0,45		kupfer / copper	5,60
40617	8,5	8,5	0,35		kupfer / copper	4,20
40618	8,5	8,5	0,35		gehämmerte Oberfläche / hammered	4,60



Snackholder

serving cup
vaso para servir
gobelet à apéritif



	Ø cm	↑ cm	ltr.		€
40605	9,5	8,5 / 11,5	0,45		4,90
40606	8,5	8,5	0,35		3,60
40607	8,5	8,5	0,35	gehämmerte Oberfläche / hammered	4,00



Servier- / Saucen-Eimer „SNACKHOLDER“

mini stainless steel bucket
cubo inox en formato mini
seau mini inox



	Ø cm	↑ cm	ltr.	pcs.	€
40630	7	6,5	0,15	4	12,00
40631	9	8,5	0,33	1	4,20



Mini-Milchkanne „SNACKHOLDER“

mini milk can
lechera en formato mini
pot à lait mini



	Ø cm	↑ cm	ltr.	pcs.	€
40640	4,5	5	0,08	4	14,00

	Ø cm	↑ cm	ltr.	pcs	€
40641	7,5	9,5	0,45	1	8,00



Mini-Seiher „SNACKHOLDER“

mini colander
colador en formato mini
passoire mini



	Ø cm	↑ cm	€
40650	10	6	2,70



Mini-Servierpfanne „SNACKHOLDER“

mini pan
sartén en formato mini
poêle à frir mini



	cm	↑ cm	ltr.	€
40660	14,5 x 9,5	4,5 / 6,5	0,5	9,00



Wachspapier „SNACKHOLDER“

greaseproof paper squares
papel alimenticio para cucurucho
papier alimentaire pour cornet

	cm	pcs.		€
40670	42 x 25	500	Motiv: Zeitung	57,00
40671	42 x 25	500	blank	31,00

	cm	pcs.		€
40672	42 x 25	500	Motiv: rote Karos / red	57,00
40673	42 x 25	500	Motiv: blaue Karos / blue	57,00
40674 <small>NEW</small>	42 x 25	500	Motiv: Fast Food / black	37,00



40672



40673



40674



40664

Teller „ENAMELWARE“

plate
plato
assiette



	Ø cm	↑ cm	Farbe / Colour		€
40664	20	2,0		flacher Teller	5,20
40665	24	2,0		flacher Teller	6,00
40666	26	2,0		flacher Teller	6,40



40662

Teller „ENAMELWARE“

plate
plato
assiette



	Ø cm	↑ cm	Farbe / Colour		€
40661	18	3,5		tiefer Teller	6,50
40662	22	3,5		tiefer Teller	7,00
40663	24	3,5		tiefer Teller	7,80



40668

Schale „ENAMELWARE“

bowl
cuenco
bol



	cm	↑ cm	ltr.	Farbe / Colour	€
40667	16 x 12	3,5	0,20		6,60
40668	18 x 13,5	4,0	0,35		6,90



Schale „ENAMELWARE“

bowl
cuenco
bol



	cm	↑ cm	ltr.	Farbe / Colour	€
40669	28 x 23	4,5	1,9		12,00



Henkelbecher „ENAMELWARE“

beaker
vaso coctelero
bol mélangeur



	Ø cm	↑ cm	ltr.	Farbe / Colour	€
40636	7	5	0,10		4,60
40632	9	8	0,35		5,40
40637	10	9	0,50		6,80



Henkelbecher „ENAMELWARE“

beaker
vaso coctelero
bol mélangeur



	Ø cm	↑ cm	ltr.	Farbe / Colour	€
40633	9	8	0,35		5,40



Henkelbecher „ENAMELWARE“

beaker
vaso coctelero
bol mélangeur



	Ø cm	↑ cm	ltr.	Farbe / Colour	€
40634	9	8	0,35		5,40



Henkelbecher „ENAMELWARE“

beaker
vaso coctelero
bol mélangeur



	Ø cm	↑ cm	ltr.	Farbe / Colour	€
40635	9	8	0,35		5,40



Schale „ENAMELWARE“

bowl
cuenco
bol



	Ø cm	↑ cm	ltr.	Farbe / Colour	€
40645	7,0	4,5	0,08		3,90
40646	8,0	3,5	0,08		3,90
40638	13,0	6,0	0,50		6,00
40647	16,5	4,5	0,45		5,00

Original Weck



Weck-Flaschen, 6er Set

Weck-bottles
Weck-botellas
Weck-bouteilles



6 Flaschen + 6 Deckel, ideal zum Servieren von Saft, Smoothie, Dressing und Saucen
6 bottles + 6 covers, ideal for serving juice, smoothie, dressing and sauces
6 botellas + 6 tapas, ideal para servir zumo, licuado, aliño y salsas
6 bouteilles + 6 couvercles, idéal pour servir de jus, smoothie, vinaigrette et sauces

	Ø cm	↑ cm	ltr.	pcs	€
82307	6	14,5	0,25	6	10,90



Weck-Flaschen, 6er Set

Weck-bottles
Weck-botellas
Weck-bouteilles



6 Flaschen + 6 Deckel, ideal zum Servieren von Saft, Smoothie, Dressing und Saucen
6 bottles + 6 covers, ideal for serving juice, smoothie, dressing and sauces
6 botellas + 6 tapas, ideal para servir zumo, licuado, aliño y salsas
6 bouteilles + 6 couvercles, idéal pour servir de jus, smoothie, vinaigrette et sauces

	Ø cm	↑ cm	ltr.	pcs	€
82308	6	19	0,5	6	12,10



Weck-Flaschen, 6er Set

Weck-bottles
Weck-botellas
Weck-bouteilles



6 Flaschen + 6 Deckel, ideal zum Servieren von Saft, Smoothie, Dressing und Saucen
6 bottles + 6 covers, ideal for serving juice, smoothie, dressing and sauces
6 botellas + 6 tapas, ideal para servir zumo, licuado, aliño y salsas
6 bouteilles + 6 couvercles, idéal pour servir de jus, smoothie, vinaigrette et sauces

	Ø cm	↑ cm	ltr.	pcs	€
82309	6	25,5	1,0	6	14,20



Weck-Gläser mit Deckel, 12er Set

Weck-glasses with lid
Weck tarros de vidrio con tapa
Weck verrines avec couvercle



12 Gläser + 12 Deckel
12 glasses + 12 covers
12 vasos + 12 tapas
12 verrines + 12 couvercles

	Ø cm	↑ cm	ltr.	pcs	€
82316	7	8,0	0,22	12	19,70



Weck-Gläser mit Deckel, 12er Set

Weck-glasses with lid
pack de 12 tarros de vidrio con tapa
pack de 12 pots en verre avec couvercle



12 Gläser + 12 Deckel
12 glasses + 12 cover
12 vasos + 12 tapas
12 verrines + 12 couvercles

	Ø cm	↑ cm	ltr.	pcs	€
82345	9	6,0	0,20	12	19,70



Weck-Gläser mit Deckel, 3er Set

Weck-glasses with lid, 3 pcs.
Weck tarros de vidrio con tapa
Weck verrines avec couvercle



3 Gläser + 3 Deckel
3 glasses + 3 covers
3 vasos + 3 tapas
3 verrines + 3 couvercles

	Ø cm	↑ cm	ltr.	pcs	€
82346	11	7,5	0,37	3	6,10



Weck-Gläser mit Deckel, 2er Set

Weck-glasses with lid, 2 pcs.
Weck tarros de vidrio con tapa
Weck verrines avec couvercle



2 Gläser + 2 Deckel
2 glasses + 2 covers
2 vasos + 2 tapas
2 verrines + 2 couvercles

	Ø cm	↑ cm	ltr.	pcs	€
82347	11	11	0,58	2	5,40



Gourmetgläser, 12er Set

gourmet glasses, 12 pcs.
tarros gourmet, set de 12 unidades
verres gourmet, pack de 12



	Ø cm	↑ cm	ltr.	pcs	€
82359	5	3,5	0,035	12	8,20
82370	6	5,5	0,08	12	11,00
82371	6	8,0	0,16	12	11,70

12er Set ohne Deckel
12 pcs. set without cover



Weck-Gläser mit Deckel, 12er Set

Weck-glasses with lid
Weck tarros de vidrio con tapa
Weck verrines avec couvercle



12 Gläser + 12 Deckel
12 glasses + 12 covers
12 vasos + 12 tapas
12 verrines + 12 couvercles

	Ø cm	↑ cm	ltr.	pcs	€
82310	6	5,5	0,08	12	18,00
82312	6	7,0	0,14	12	19,70
82314	6	8,0	0,16	12	19,70



passende Gläser:
82310
82312
82314

Serviergestell „WECK“

serving stand
expositor
présentoir



ohne Gläser
without glasses
sin vasos
sans verrines

	Ø cm	↑ cm		€
33246	22	59	12 x Ø 6 cm	85,00



passende Gläser:
82310
82312
82314

Serviergestell „WECK“

serving stand
expositor
présentoir



ohne Gläser
without glasses
sin vasos
sans verrines

	Ø cm	↑ cm		€
33247	22	33	6 x Ø 6 cm	54,00



Weck-Frischhaltedeckel, 5er Set

airtight cover, 5 pcs.
tapa hermética, 5 pz.
couvercle hermétique, 5 pc.

für Rundrandgläser Ø 6 cm, 5er Set

for Ø 6 cm glasses, 5 pcs. set

para vasos Ø 6 cm, 5 pc.

pour verrines Ø 6 cm, set de 5



	Ø cm	pcs	€
82338	7	5	2,30



10er Set Gummidichringe

10 pcs. rubber washer

10 juntas de goma

jeu de 10 joints caoutchouc

für Deckel der Weck-Gläser, im Beutel verpackt

for covers of Weck-glasses

para las tapas de los tarritos Weck

pour la fermeture des verrines Weck

	fits to	€
82318	82307, 82308, 82309, 82310, 82312, 82314, 82316	1,20
82394	82345	1,20
82395	82346, 82347	1,30



8er Set Deckel-Klammer für 4 Weck-Gläser

8 pcs. cover clamps for 4 Weck-glasses

8 abrazaderas para 4 vasitos Weck

8 agrafes pour 4 verrines Weck



	€
82319	2,30



Topf darf nicht erhitzt werden!
Topf ist nicht zum Kochen geeignet!

Muscheltopf

mussel pot

mejillonera

casserole à moules

schwarz emailliertes Stahlblech, mit Edelstahlrand

black enamelled steel, stainless steel rim

hierro esmaltado negro, borde inox

acier émaillé noir, bord inox



	Ø cm	↑ cm	ltr.	€
00623	13,5	9	0,8	6,00
00625	18	12	2,0	10,00
00626	20	13	3,0	11,00
00627	24	13,5	4,0	12,00

Tableware . Table Presentation



Rindenholzbrett „NATURA“

wood plater
tabla de madera con corteza
planche en bois avec écorce



Akazienholz mit Rinde, jedes Brett ein Unikat, vor dem Erstgebrauch mit Speiseöl behandeln
acacia wood with bark, each board unique, treat with cooking oil before first use
madera de acacia con corteza, cada tabla un ejemplar único, tartar con aceite de cocina antes del primer uso
bois d'acacia avec écorce, chaque planche une modèlle unique, traiter avec de l'huile de caisson avant la première utilisation

	cm	↑ cm	€
00895	26,0 x 24,0	2	12,00
00896	30,0 x 28,5	2	14,00



Besteckbehälter „TIN“

cutlery bin
recipiente
réceptient



Behälter aus Metall mit Tragegriff aus Holz
container made of metal with wooden handle
contenedor de metal con asa de madera
conteneur métallique avec poignée en bois

	cm	↑ cm	€
00014	24,5 x 12	18,5	8,90



Naturschieferplatte

natural slate tray
bandeja pizarra natural
plat ardoise naturelle



mit Absatz Ø 6 cm
with hole Ø 6 cm
con agujero Ø 6 cm
avec trou Ø 6,0 cm

	cm	mm	€
00986	25 x 12	6 - 9	3,90



Naturschieferplatte

natural slate tray
bandeja pizarra natural
plat ardoise naturelle



mit 3 Absätzen, Ø 6 cm
with 3 holes, Ø 6 cm
con 3 agujeros, Ø 6 cm
avec 3 trous, Ø 6 cm

	cm	mm	€
00987	28 x 10	6 - 9	5,40



Naturschieferplatte „STARTER“

natural slate tray
bandeja de pizarra natural
plat ardoise naturelle carré



	cm	✱ mm	€
00937	20 x 10	6 - 9	2,90



Weck-Glas 82316

Naturschieferplatte / Untersetzer

natural slate tray
bandeja de pizarra natural
plateau ardoise naturelle



mit 2 Absätzen Ø 6 cm
with 2 holes Ø 6 cm
con 2 agujeros Ø 6 cm
avec 2 trous Ø 6 cm

	cm	✱ mm	€
00971	15 x 8	6 - 9	3,00



Naturschieferplatte, 2-teilig

natural slate tray, 2 pcs. set
bandeja de pizarra natural y campana
plateau ardoise naturelle et cloche en verre

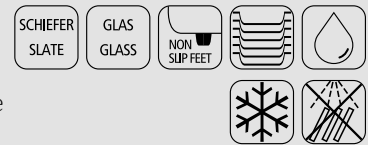

mit Glashaube
with glass cover
con tapa de cristal
avec cloche en verre

	Ø cm	↑ cm	✱ mm	€
00984	10,5	8	6 - 9	8,00



Naturschieferplatte

natural slate tray
bandeja de pizarra natural
plat ardoise naturelle



	cm	✱ mm	€
00996	45 x 30	6 - 9	12,00



Naturschieferplatte

natural slate tray
bandeja de pizarra natural
plat ardoise naturelle



	cm	✱ mm	€
00994	25 x 25	6 - 9	6,00
00995	30 x 30	6 - 9	9,00

Tableware . Table Presentation



Tablett „ELEGANCE“

tray
bandeja
plateau



	cm	€
02310	41 x 26	12,60
02311	48 x 30	16,00
02312	60 x 37	24,00



06401
Haube

2364
Königskuchenplatte

Tablett mit Haube „ELEGANCE“

tray with cover
bandeja con cubierta
plateau avec cloche



	cm	↑ cm	€
23642	35 x 19	10	9,00



00064
Königskuchenplatte

00067
Frischhaltebox

Serviertablett „FLASH“ mit Haube

tray
bandeja
plateau



	cm	↑ cm	€
00064	34 x 16,5	10	5,90
00067	25 x 19	7	6,40

Haube für 00064 / cover for 00064 / campana para 00064 / cloche pour 00064

	€
06401	3,00

Haube für 00067 / cover for 00067 / campana para 00067 / cloche pour 00067

	€
06701	2,00



7cm Haubenhöhe + 11cm Haubenhöhe

Tortenplatte mit Haube

cake plate with cover
bandeja tarta con campana
plat à tarte avec cloche



	Ø cm	↑ cm		€
00065	30	11	mit 1 Haube / with 1 cover	6,40
00652	30	7 + 11	mit 2 Hauben / with 2 cover	7,90



Tortenplatte „BAROK“

cake plate
bandeja tartas
plat à gâteau



2-teilig: Tortenplatte mit Barock-Rand + Haube (extra stabil)

2 pcs. set: cake plate with decor edge „Barok“ + cover (extra robust)

set 2 piezas: porta tartas, borde decor „Barok“ + campana (extra fuerte)

set 2 pcs: plateau bord décor „Barok“ + cloche ultra-résistante

	Ø cm	↑ cm	€
06503	32	10	10,00

Frischhalte-Haube / cover / campana / cloche

	Ø cm	↑ cm	€
06510	30	11,5	4,40



Servier- / Tortenplatte

cake stand
soporte para pastel
présentoir à gâteaux

hochglanzpoliert, mit hohem Fuß (fest verbunden)

mirror polished finish, with tall foot
acabado brillante, con pie alto
poli brillant, pied haut



	∅ cm	↑ cm	€
00466	34,5	13,5	49,00



Servier- / Tortenplatte

cake stand
soporte para pastel
présentoir à gâteaux

Fuß hochglanzpoliert, Platte matt poliert, stabil und sehr standsicher

foot mirror polished finish, plate satin polished finish
pie pulido brillante, bandeja pulida mate
pied brillant, plateau poli satin mat



	∅ cm	↑ cm	€
00462	30	11	42,00



Servier- / Tortenplatte

cake stand
soporte para pastel
présentoir à gâteaux

matt poliert, drehbar, möbelschonende Moosgummi-Unterseite

satin polished finish, rotating, foam rubber below to save your furniture
acabado pulido satinado, giratorio, base revestida de goma para no rallar el mobiliario
poli satiné, plateau tournant, revêtement mousse sous le pied pour ne pas rayer les meubles



	∅ cm	↑ cm	€
00463	30,5	9	38,00



Servier- / Tortenplatte

cake stand
soporte para pastel
présentoir à gâteaux

Fuß matt poliert, stabil und sehr standsicher, möbelschonende Moosgummi-Unterseite

foot satin polished finish, foam rubber below to save your furniture
pie pulido con efecto satinado, base revestida de goma para no rallar el mobiliario
inox poli satin, revêtement mousse sous le pied pour ne pas rayer les meubles



	∅ cm	↑ cm	€
00464	30	11	18,50

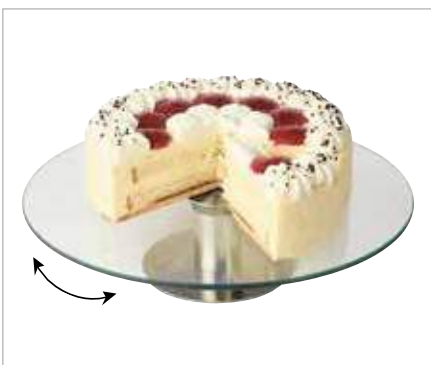

Servier- / Tortenplatte

cake stand
soporte para pastel
présentoir à gâteaux

Fuß matt poliert, drehbar, möbelschonende Moosgummi-Unterseite

foot satin polished finish, rotating, foam rubber below to save your furniture
vidrio, pie inox satinado giratorio, base de goma para proteger el mobiliario
plateau en verre, pied tournant inox poli satin, revêtement mousse sous le pied anti-rayures



	∅ cm	↑ cm	€
00444	30	7	18,90



Konditorplatte
 cake stand
 soporte para pastel
 présentoir à gâteaux



	Ø cm	↑ cm	€
00046	31	3	12,50

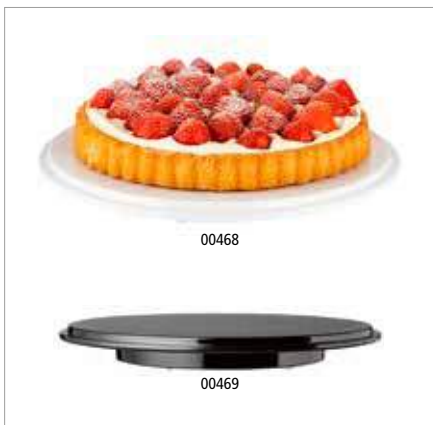

Torten- / Konditorplatte
 cake stand
 soporte para pastel
 présentoir à gâteaux



Rand fixiert die Haube, mit Antirutsch-Füßchen
 carved edge fixes the cover, non-slip feet
 ranura para fijar bien la campana, pies antideslizantes
 bord rainuré pour maintenir ferme la cloche, pieds antiglisse

	Ø cm	↑ cm	Farbe / Colour	€
00468	31	4	White	15,00
00469	31	4	Black	15,00



Servier- und Tortenplatte „CASUAL“
 cake plate
 porta pasteles
 présentoir à gâteaux



	Ø cm	↑ cm	€
83890	31	8	24,00
83891	31	16	30,00



Servier- und Tortenplatte „CASUAL“
 cake plate
 porta pasteles
 présentoir à gâteaux



	cm	↑ cm	€
83892	31 x 31	8	27,00
83893	31 x 31	16	32,50



Frischhalte-Haube
 cover
 campana
 cloche



	Ø cm	↑ cm	fits to	€
06520	30	22	84242, 84177, 83892, 83891, 83890, 83884, 15303, 998, 975, 469, 468, 463, 462 46,	29,90



Kaviarkühler
 caviar cooler
 enfriador de caviar
 rafraîchisseur de caviar



4-teilig: Glasschale Ø 10 cm
 4 pcs.: glass bowl Ø 10 cm
 4 piezas: bol Ø 10 cm
 4 éléments: bol Ø 10 cm

	Ø cm	↑ cm	€
01699	18	12	49,90



Edelstahlschale, doppelwandig

stainless bowl, double wall
bol inox doble pared
bol inox double paroi

beste Isoliereigenschaften
best insulating properties
muy aislante
très isolant

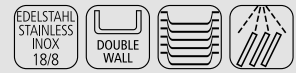

	Ø cm	↑ cm	ltr.	€
30040	14	6,5	0,5	17,80
30041	20	9	1,5	23,00
30042	23	10	2,5	29,00



Spießständer / Spieße

espetada and kebab skewer rack / skewer
soporte para brochetas
support pour brochettes

zum Servieren von Fleischspießen bis 40 cm, Gestell aus 8 mm Edelstahl

to serve skewers up to 40 cm, wire stainless steel 8 mm
para servir brochetas de carne hasta 40 cm, grosor del alambre 8 mm, inox
pour présenter les brochettes long. maxi 40 cm, fil 8 mm, inox



	Ø cm	↑ cm		€
75001	22	46		33,00
75002	0,3	40	4er Set / 4 pcs. set	8,00



Butterservierer

butter dish
mantequillera
beurrier

hochglanzpoliert
mirror polished finish
acabado brillante
poli brillant



	Ø cm	↑ cm		€
15921	9	7		12,60



Butterservierer

butter dish
mantequillera
beurrier



	Ø cm	↑ cm		€
15925	9	9		7,00



Butterservierer

butter dish
mantequillera
beurrier



	cm	↑ cm		€
15926	9 x 9	9		7,00

Tableware . Table Presentation



Sauciere

gravy boat
salsera
saucière



hochglanzpoliert, extra schwere Qualität

mirror polished finish, high quality

acabado efecto espejo, alta calidad, base pesada

poli brillant, belle qualité, pied pesant

	cm	↑ cm	ltr.	€
40208	13 x 6,0	9,0	0,10	6,00
40204	16 x 7,5	9,0	0,15	7,00
40205	19 x 9,0	13,0	0,25	9,00
40206	22 x 10,5	13,5	0,45	11,00



Sauciere

gravy boat
salsera
saucière



poliert

polished

pulido

poli

	cm	↑ cm	ltr.	€
40200	18,0 x 7,5	7,0	0,10	4,60
40203	21,5 x 9,5	8,5	0,15	5,40
40201	23,5 x 10,0	10,0	0,20	5,60
40202	23,5 x 12,0	12,0	0,45	6,70



Thermo-Sauciere

insulated sauce boat
salsera isotérmica
saucière thermique



doppelwandig, Klappdeckelverschluss, Einhandbedienung

double wall, hinged cover, one-hand operation

doble pared, tapa con bisagra, se maneja con 1 mano

double paroi, couvercle avec charnière, usage 1 main

	cm	↑ cm	ltr.	€
40207	19 x 12,5	13	0,4	14,00



NEW

Gourmet-Löffel „GUN-METAL“

party spoon
cuchara gourmet
cuillère gourmet



	→ cm			€
00693	12	black / gun-metal look	made from PVD coated stainless steel	5,00



Gourmet-Löffel „CLASSIC“

party spoon
cuchara gourmet
cuillère gourmet



	→ cm			€
00677	13,5	Edelstahl-Look / stainless steel look		2,40
00691	12	Gold-Look / gold look	made from PVD coated stainless steel	5,00
00692	12	Kupfer-Look / copper look	made from PVD coated stainless steel	5,00



Stielkasserolle / Serviertopf

sauté pan / mini sauce pan
cazo recto bajo
plat à sauter



	∅ cm	↑ cm	ltr.		€
40642	5	3	0,07	Griff: 6 cm / handle: 6 cm asa: 6 cm / poignée: 6 cm	4,40
40643	7	4,5	0,14	Griff: 9 cm / handle: 9 cm asa: 9 cm / poignée: 9 cm	5,00
40644	9	6	0,36	Griff: 9 cm / handle: 9 cm asa: 9 cm / poignée: 9 cm	7,90



Glocke

cloche / dome cover
campana esférica
cloche demi-sphère

außen hochglanzpoliert, innen matt poliert, mit verchromten Griff

outside mirror polished finish, inside satin polished finish, with chromeplated handle

exterior pulido acabado efecto espejo, interior pulido acabado efecto satinado, pomo cromado
extérieur poli brillant, intérieur poli satin, buton chromé

	Ø cm	↑ cm	€
35734	29	18	44,00



Platzteller

plate tray
bajo plato
assiette de présentation



Rand eingerollt

rolled edge
borde redondeado
bord rond

	Ø cm		€
35930	31	matt poliert / satin polished finish acabado efecto satinado / fini mat effet satin	14,20
35735	31	hochglanzpoliert / mirror polished pulido brillante / poli brilliant	15,00



Platzteller

plate tray
bajo plato
assiette de présentation



hochglanzpoliert, mit Fadendekor

mirror polished finish, with line edge
pulido efecto espejo, con un filo en relieve
poli miroir, filet relief

	Ø cm		€
35730	30,5		14,40
36233	33,0		19,20



Platzteller

plate tray
bajo plato
assiette de présentation



hochglanzpoliert, mit Perland

mirror polished finish, with pearl edge
acabado pulido efecto espejo, con borde aperlado
poli miroir, bord perlé

	Ø cm		€
35720	30,5		14,60
36323	33		18,20

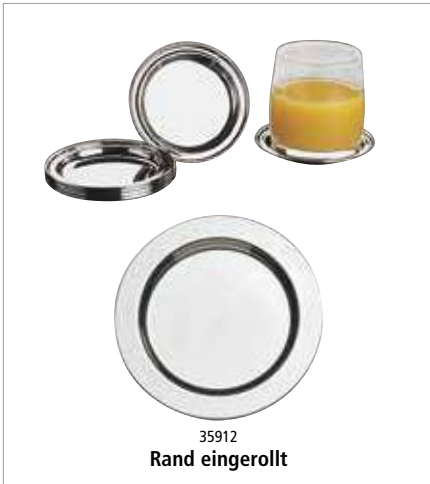

35912
Rand eingerollt

Untersetzer

coaster
posavasos
plateau sous-verre



hochglanzpoliert, schwere Ausführung, Rand eingerollt
mirror polished finish, heavy quality, rolled edge
acabado pulido efecto espejo, alta calidad, borde redondeado
effet miroir, bord rond, qualité extra

	Ø cm	pcs.	€
35711	10	6	15,00
35912	12	6	13,90



Serviettenringe, 6er Set

napkin rings, 6 pcs. set
servilleteros, set de 6
anneaux à serviettes, set de 6



	cm	↑ cm	pcs.	€
04445	6,5 x 4,5	1	6	22,40



Serviettenringe, 4er Set

napkin rings, 4 pcs. set
servilleteros, set de 4
anneaux porte-serviette, set de 4



	Ø cm	↑ cm	pcs.	€
04446	4,5	2,5	4	6,40



00058

00581

Tischkrümelentferner

crumber
recogemigas
ramasse-miettes



matt poliert
satin polished finish
acabado mate, fácil de usar, mango hueco
mat satiné, manche creux, simple à utiliser

	Ø cm	↑ cm		€
00058	6,5 x 2,5	22	Hohlgriff / hollow handles	14,80
00581	19 x 4,5	1	geschliffene Edelstahlkante flat grinded stainless steel edge	7,20

Tableware . Table Presentation



Besteckkorb „ECONOMIC“

cutlery dispenser
dispensador de cubiertos
corbeille à couverts



in Handarbeit geflochten

wickerwork
trensado a mano
tressage à main

	Ø cm	↑ cm	Farbe / Colour	€
40130	12	15		3,20
40007	12	15		3,20
40012	12	15		3,20
40013	12	15		3,20



Besteckkorb „ECONOMIC“

cutlery dispenser
dispensador de cubiertos
corbeille à couverts



in Handarbeit geflochten

wickerwork
trensado a mano
tressage à main

	cm	↑ cm	Farbe / Colour	€
40131	27 x 10	4,5		3,20
40009	27 x 10	4,5		3,20
40010	27 x 10	4,5		3,20
40011	27 x 10	4,5		3,20



Table Caddy „COUNTRY STYLE“

table barrel
caddy de mesa
caddy de table



cooler Country-Style, nicht für den direkten Kontakt mit Lebensmitteln verwendbar

make for cool condiment and cutlery holders or even for food presentation, the mini barrels should not come into contact with food, they should be lined with our greaseproof paper

estilo campo, no aptos para el contacto directo con alimentos, sólo usando papel alimenticio

de style champêtre, pas de contact direct avec aliments, seulement en utilisant papier alimentaire

	Ø cm	↑ cm	€
11930	17,5	8,5	19,00
11931	11,5	14,0	19,00



Tischreste- / Besteckbehälter

table garbage bin / cutlery bin
 papelera de sobremesa / recipiente para cubiertos
 poubelle de table / récipients pour couverts



matt poliert, mit abnehmbaren Lochdeckel
 satin polished finish, with removeable cover
 acabado pulido satinado, con tapa desmontable
 poli mat satiné, avec couvercle démontable ouvert au centre

	Ø cm	↑ cm	ltr.	€
00028	10	12	0,7	12,00



Tischrestebehälter

table garbage bin
 papelera de sobremesa
 poubelle de table



matt poliert, abnehmbarer Schwingdeckel, mit Bajonettverschluss „fester Deckelsitz“
 satin polished finish, swing cover, cover removable
 acabado satinado, tapa basculante desmontable
 poli mat satiné, couvercle basculant démontable

	Ø cm	↑ cm	ltr.	€
00029	12	17	1,2	16,00
00027	10	13	0,7	12,00



Tischreste- / Besteckbehälter

table waste bin / cutlery bin
 papelera de sobremesa / recipiente para cubiertos
 poubelle de table / récipients pour couverts



mit verchromten Rand, inkl. herausnehmbarem Einteiler (4 Fächer)
 with chrome plated ring, incl. divider (4 chambers)
 con anillo cromado
 avec bord chromé

	cm	↑ cm	Farbe / Colour	€
00016	14 x 14	16	■	19,00



Tischrestebehälter „SUNDAY“

table waste bin
 papelera de sobremesa
 poubelle de table



matt poliert, inkl. Deckel, fester Deckelsitz
 satin polished finish, incl. cover, cover removable
 acero inoxidable mate, con tapa
 inox mat, avec couvercle

	Ø cm	↑ cm	ltr.	€
00024	10	18	1,1	23,90



Tischrestebehälter

table garbage bin
 papelera de sobremesa
 poubelle de table



Behälter aus weiß lackiertem Metall, Edelstahl-Lochdeckel
 metall white, stainless cover with hole
 tapa, acero inoxidable, con apertura
 couvercle inox, avec ouverture centrale, récipient en acier laqué blanc

	Ø cm	↑ cm	ltr.	€
00292	12	15	1,2	14,00

Tableware . Table Presentation



Tischrestebehälter

table garbage bin
papelera de sobremesa
poubelle de table



Behälter aus weiß lackiertem Metall, abnehmbarer Schwingdeckel

cover stainless steel bin metal, white, swing cover
tapa de acero inoxidable, recipiente chapa lacada blanca
couvercle inox basculant, récipient en acier laqué blanc

	Ø cm	↑ cm	ltr.	€
00291	12	17	1,2	14,00



Tischrestebehälter „INTERNATIONAL“

table waste bin
papelera de sobremesa
poubelle de table



Deckel-Ring mit Dichtung, internationale Beschriftung

cover with sealing ring
tapa con junta, texto multi-idiomas
couvercle avec joint, texte multilingue

	Ø cm	↑ cm	ltr.	€
83847	10	17,5	1	9,00



Tischrestebehälter

table garbage bin
papelera de sobremesa
poubelle de table



	Ø cm	↑ cm	ltr.	Farbe / Colour	€
02038	11	14	0,9	White	2,60
02039	11	14	0,9	Black	2,60



Tischrestebehälter

table garbage bin
papelera de sobremesa
poubelle de table



	Ø cm	↑ cm	ltr.	€
00311	14	15	1,2	3,60



Tischrestebehälter

table garbage bin
papelera de sobremesa
poubelle de table



Kunststoff weiß / granit, abnehmbarer Schwingdeckel

white plastic, swing cover, cover removable
plástico blanco/granito, tapa basculante desmontable
plastique blanc/gris chiné, couvercle basculant démontable

	Ø cm	↑ cm	ltr.	€
00031	12	18	1,4	5,40



Besteckbehälter mit Tragegriff
cutlery bin with handle
recipiente para cubiertos con asa
récipient pour couverts avec poignée



Behälter aus Melamin. Der abnehmbare Tragegriff aus Holz wird mit 4 Gummibändern fixiert.
Container made of melamine. The removable wooden handle is fixed with 4 rubber bands.
Contenedor de melamina. El asa de madera extraíble se fija con 4 cintas elásticas.
Conteneur en mélamine. La poignée en bois amovible est fixée avec 4 bandes élastiques.

	cm	↑ cm	ltr.	€
84870	23,5 x 17	18	2,1	24,00



Besteckbehälter „TIN“
cutlery bin
recipiente
récipient



Behälter aus Metall mit Tragegriff aus Holz
container made of metal with wooden handle
contenedor de metal con asa de madera
conteneur métallique avec poignée en bois

	cm	↑ cm	€
00014	24,5 x 12	18,5	8,90



Tischrestebehälter
table garbage bin
papelera de sobremesa
poubelle de table



	Ø cm	↑ cm	ltr	€
83999	13 / 9	14	1,2	11,50



Abtropf-
löcher
drainer
holes

Besteckköcher
cutlery basket
cesta para cubiertos
corbeille à couverts



	cm	↑ cm	Farbe / Colour	€
84535	12 x 12	16		4,90
84536	12 x 12	16		4,90



Besteckständer
cutlery basket
cesta para cubiertos
égouttoir à couverts



	Ø cm	↑ cm	€
11921	10	10,0	7,40
11922	12	13,5	9,90



Besteckbehälter „ELEMENT“

cutlery bin
recipiente para cubiertos
récipients pour couverts



mit Abflussloch, mit Besteck Logo, Bodeneinlagen aus Silikon zum Schonen der Messerspitzen, möbelschonende Unterseite

with drain hole, with cutlery logo, silicone floor inserts for saving the points of knives, with non-scratching undersurface

con orificio de drenaje, con logotipo de cubertería, soporte de silicona para proteger las puntas de los cuchillos, con base antirrayaduras

avec le trou de drainage, avec le logo de coutellerie, insert de silicone pour protéger les pointes des couteaux, avec base revêtue antirayures

	Ø cm	↑ cm	€
00018	11	14	14,50



Tischreste- / Besteckbehälter „TOP CHROME“

table waste bin / cutlery bin
papelera de sobremesa / recipiente para cubiertos
poubelle de table / récipients pour couverts



mit verchromten Rand

with chrome plated ring

con anillo cromado

avec bord chromé

	Ø cm	↑ cm	ltr.	Farbe / Colour	€
00025	13	15	1	White	6,00
00026	13	15	1	Black	6,00



Tischreste- / Besteckbehälter „BASE CHROME“

table waste bin / cutlery bin
papelera de sobremesa / recipiente para cubiertos
poubelle de table / récipients pour couverts



mit verchromten Boden

with chrome bottom

con base cromada

avec base chromée

	Ø cm	↑ cm	ltr.	Farbe / Colour	€
00019	13	15	1,3	White	6,00
00020	13	15	1,3	Black	6,00



Besteckköcher

cutlery basket
cesta para cubiertos
corbeille à couverts



	Ø cm	↑ cm	€
11998	9,7	13,7	Kunststoff weiß / white plastic plástico blanco / plastique blanc 2,50
11999	9,7	13,7	matt poliert / satin polished finish acero inoxidable / inox 7,90

11998
Köcher weiß

11999
Köcher Edelstahl



Kartenhalter, 4er Set

table stands, 4 pcs. set
portatarjetas, set de 4
porte-cartes, set de 4



hochglanzpoliert, inkl. 20 schwarze Beschriftungskarten aus Polypropylen
mirror polished finish, incl. 20 black cards made of polypropylene
pulido brillante, incl. 20 tarjetas negras de polipropileno
poli miroir, incl. 20 étiquettes noires en polypropylène

	Ø cm	↑ cm	pcs.	Farbe / Colour	€
71510	5	10,5	4	stainless steel	19,00
71511	5	10,5	4	copper	22,00
71512	5	10,5	4	gunmetal	22,00

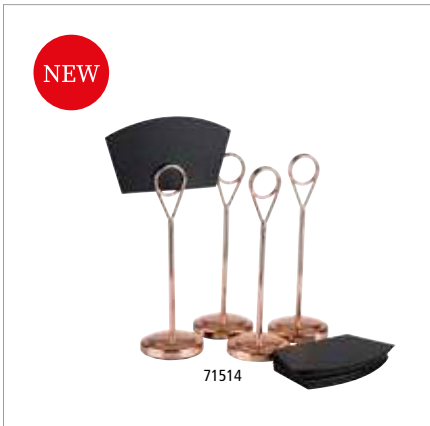

Kartenhalter, 4er Set

table stands, 4 pcs. set
portatarjetas, set de 4
porte-cartes, set de 4



hochglanzpoliert, inkl. 20 schwarze Beschriftungskarten aus Polypropylen
mirror polished finish, incl. 20 black cards made of polypropylene
pulido brillante, incl. 20 tarjetas negras de polipropileno
poli miroir, incl. 20 étiquettes noires en polypropylène

	Ø cm	↑ cm	pcs.	Farbe / Colour	€
71513	5	15,5	4	stainless steel	20,00
71514	5	15,5	4	copper	24,00
71515	5	15,5	4	gunmetal	24,00



Kartenhalter, 4er Set

table stands, 4 pcs. set
portatarjetas, set de 4
porte-cartes, set de 4



hochglanzpoliert, inkl. 20 schwarze Beschriftungskarten aus Polypropylen
mirror polished finish, incl. 20 black cards made of polypropylene
pulido brillante, incl. 20 tarjetas negras de polipropileno
poli miroir, incl. 20 étiquettes noires en polypropylène

	Ø cm	↑ cm	pcs.	Farbe / Colour	€
71516	5	20,5	4	stainless steel	22,00
71517	5	20,5	4	copper	26,00
71518	5	20,5	4	gunmetal	26,00



Kartenhalter-Set

card holder set
portatarjetas, set
porte-cartes, set



18-teilig: 6 Kartenhalter 4 x 2,5 cm + 12 Kunststoff-Beschriftungskarten 10 x 6 cm
18 pcs. set: 6 card holder 4 x 2,5 cm + 12 plastic cards of inscription 10 x 6 cm
set de 18: 6 soportes 4 x 2,5 cm + 12 tarjetas de plástico 10 x 6 cm
set de 18: 6 supports 4 x 2,5 cm + 12 étiquettes en plastique 10 x 6 cm

	cm	€
00022	4 x 2,5	12,00



Beschriftungskarten, 10er Set

designation cards, 10 pcs. set
tarjetas, set de 10
étiquettes, set de 10



	cm	* mm	€
00037	7,5 x 5	0,4	4,90

Tableware . Table Presentation



Bankettkartenständer

menu stand / table number
porta-etiqueta o carta de sobremesa
porte-étiquette de table, porte-menu, ou n° de table



hochglanzpoliert, schwere Qualität
mirror polished finish, heavy gauge
acero inoxidable de alta calidad
inox, belle qualité

	Ø cm	↑ cm	€
71460	7,5	18,5	8,00
71461	7,5	29	10,40
71462	7,5	46	11,50



Tischkartenhalter, 4er Set

table stands, 4 pcs. set
set de 4 pinzas porta-etiquetas
pack de 4 porte-étiquettes à pince



hochglanzpoliert, schwerer Fuß, inkl. 20 weiße Beschriftungskarten
mirror polished finish, heavy food, incl. 20 white labels
acabado brillante, incluye 20 etiquetas en blanco
poli brillant, inclut 20 étiquettes blanches

	Ø cm	↑ cm	pcs.	€
00070	4	10	4	20,00



Tischaufsteller, 10er Set

table stands, 10 pcs. set
caballes de mesa, set de 10 pz.
chevalets de table, set de 10 pc.



Ecken abgerundet
corners rounded
esquinas redondeadas
coins arrondies

	cm	↑ cm	pcs.	€
00011	7,5 x 3,5	5	10	6,90
00012	10,5 x 6	6,5	10	7,90



Kartenhalter, 2er Set

card holder, 2 pcs. set
set de 2 piezas, soporte de mesa
set de 2 pièces, support de table



inkl. 40 Beschriftungskarten, durch Magnete einfach zusammenklappbar
incl. 40 cards, easily foldable with magnets
incluye 40 tarjetas, fácil de plegar, con imanes
inclut 40 étiquettes, fácil à plier, avec aimants

	cm	↑ cm	pcs.	€
00076	9 x 3	5,5	2	16,00



Buffetschilder, 3er Set

buffet signs, 3 pcs. set
set de 3 piezas indicadores bufé
set de 3 petits chevalets de buffet



können mit einem wasserfesten Filzschreiber beschrieben werden
can be marked with water-based felt markers
pueden marcarse con rotuladores de agua
écriture facile avec un feutre lavable à l'eau

	cm	↑ cm	pcs.	€
03610	12,0 x 6,0	6,0	3	15,00



Kartenhalter, 2er Set

menu holder, 2 pcs. set
porta cartas de mesa, set 2 piezas
set de 2 supports pour menu de table



	cm	↑ cm	pcs.	€
00023	8,5 x 6	4,5 / 8,5	2	7,50



Kartenhalter, 2er Set

menu holder, 2 pcs. set
porta cartas de mesa, set 2 piezas
set de 2 porte-menus de table



matt poliert
satin polished finish
pulido satinado
poli mat satiné

	cm	↑ cm	pcs.	€
00021	8,5 x 4	4 / 8,5	2	8,80



Tischkartenhalter

table stand
soporte-carta para la mesa
support pour menu de table



matt poliert
satin polished finish
pulido satinado
poli mat satiné

	cm	↑ cm	pcs.	€
00030	8,0 x 7,0	2	1	2,80
00036	6,0 x 4,5	4	1	1,90



Kartenhalter-Set, 4er Set

table stands, 4 pcs. set
portatarjetas, set de 4
porte-cartes, set de 4



inkl. 30 Beschriftungskarten (15 x weiß + 15 x schwarz)
incl. 30 labels (15 x white + 15 x black)
incl. 30 tarjetas (15 x blanco + 15 x negro)
incl. 20 étiquettes (15 x blanc + 15 x noir)

	cm	↑ cm	pcs.	€
71492	3 x 3	3	4	8,00
71493	3 x 3	3	4	8,00
71494	3 x 3	12	4	8,80

Tableware . Table Presentation



Kartenhalter, 4er Set

table stands, 4 pcs. set
set 4 piezas soportes de mesa
set de 4, support de table



inkl. 20 weiÙe Beschriftungskarten

incl. 20 white labels

incluye 20 etiquetas blancas

20 étiquettes blanches incluses

	cm	↑ cm	pcs.	Farbe / Colour	€
00074	3 x 3	12	4		8,80



Kartenhalter, 4er Set

table stands, 4 pcs. set
set 4 piezas soportes de mesa
set de 4, support de table



inkl. 20 weiÙe Beschriftungskarten

incl. 20 white labels

incluye 20 etiquetas blancas

20 étiquettes blanches incluses

	cm	↑ cm	pcs.	Farbe / Colour	€
00070	2,5 x 2,5	12	4		7,30



Kartenhalter „WÜRFEL“, 4er Set

table stands, 4 pcs. set
soporte de mesa, 4 piezas
set de 4 porte-étiquettes



inkl. 20 weiÙe Beschriftungskarten, mehrfach beschriftbar

incl. 20 white labels

incluye 20 etiquetas blancas

20 étiquettes blanches incluses

	cm	pcs.	€
00078	3 x 3 x 3	4	10,00



Kartenhalter „ZYLINDER“, 4er Set

table stands, 4 pcs. set
soporte de mesa, 4 piezas
set de 4 porte-étiquettes



inkl. 20 weiÙe Beschriftungskarten, mehrfach beschriftbar

incl. 20 white labels

incluye 20 etiquetas blancas

20 étiquettes blanches incluses

	cm	pcs.	€
00079	3 x 3 x 3	4	10,00



Tafelhalter / Schild

slate sign
caballete de mesa, pizarra
plaque signalétique avec support



	cm	↑ cm	€
00060	12 x 4	7	7,00



Kartenhalter, 2er Set

table stands, 2 pcs. set
portatarjetas, set de 2
porte-cartes, set de 2

BETON
CONCRETE



inkl. 30 Beschriftungskarten (15 x weiß + 15 x schwarz)
incl. 30 labels (15 x white + 15 x black)
incl. 30 tarjetas (15 x blanco + 15 x negro)
incl. 20 étiquettes (15 x blanc + 15 x noir)

	cm	↑ cm	pcs.	€
71495	8 x 3,5	6	2	7,40



Kartenhalter, 2er Set „KLAMMER“

table stand, 2 pcs. set
set de 2 piezas, soporte de mesa
set de 2 pièces, support de table

HOLZ
WOOD



inkl. 30 Beschriftungskarten (15 x weiß, 15 x schwarz- ca. 10 x 8 cm)
incl. 30 cards (15 x white, 15 x black - 10 x 8 cm)
incluye 30 tarjetas (15 x blanco, 15 x negro - 10 x 8 cm)
inclut 30 étiquettes (15 x blanc, 15 x noir - 10 x 8 cm)

	cm	↑ cm	pcs.	Farbe / Colour	€
71487	4 x 2,5	10	2		12,00
71489	4 x 2,5	10	2		12,00

Beschriftungskarten, 50 Stück / designation cards, 50 pcs. set
cartelitos de designación, 50 piezas / cartes de désignation, 50 pièces

	cm	pcs.	Farbe / Colour	fits to	€
71498	10 x 8	50		71487, 71488, 71489	4,00
71499	10 x 8	50		71487, 71488, 71489	4,00



Tischkartenhalter „PROFI“

table stand
soporte de mesa
support de table

METALL
VERCHROMT



	cm	↑ cm	€
40425	9,5 x 7,5	13,5	7,70



Tischkartenhalter

table stand
soporte de mesa
support de table

EDELSTAHL
STAINLESS
INOX



möbelschonende Unterseite
non-scratching undersurface
con base antirrayaduras
avec base revêtue antirayures

	cm	↑ cm	€
00071	14 x 5,5	14	15,00

Tableware . Table Presentation



Schilderhalter „FLEXIBEL“

sign holder
soporte para cartelito
support pour menu de table



biegsamer Draht mit zwei Klemmen, extrem flexibel, die Klemmen lassen sich weit öffnen
bedable metal coil adds visual interest, two metal clip open
metal cromado flexible, 2 pinzas con gran apertura
métal chromé, flexible, 2 pinces à grande ouverture

	→ cm		€
71470	12	ohne Schilder / without signs sin cartelitos / sans étiquette	3,50
71471	23	ohne Schilder / without signs sin cartelitos / sans étiquette	4,20
71480	12	inkl. 10 Schilder 11879 / incl. 10 signs 11879 con 10 cartelitos 11879 / avec 10 étiquettes 11879	8,40

Schilder, 10er Set / signs, 10 pcs. set / set de 10 cartelitos / set de 10 étiquettes

	cm	€
11879	7,7 x 5,2	4,90
12879	5,0 x 3,0	4,60



10 Beschriftungsclips, inkl. 10 Schilder

10 sign holders, with 10 signs
10 soportes + 10 cartelitos
10 supports + 10 étiquettes



	cm	Farbe / Colour	€
71482	6 x 2,7	White	10,50
71483	6 x 2,7	Black	10,50

Schilder, 10er Set / signs, 10 pcs. set / set de 10 cartelitos / set de 10 étiquettes

	cm	€
11879	7,7 x 5,2	4,90
12879	5,0 x 3,0	4,60



10 Schilderhalter „FLEX CLIP“

10 sign holders
set de 10 clips
set de 10 porte-étiquettes



Durch die bewegliche Verbindung der Klemme und Schilderhalterung ein extrem flexibler Cliphalter!
multi angle ticket clip
inclinable con pinza
inclinable avec pince

	→ cm	Farbe / Colour	€
71472	9,5	White	12,00
71474	9,5	Black	12,00

Schilder, 10er Set / signs, 10 pcs. set / set de 10 cartelitos / set de 10 étiquettes

	cm	pcs.	€
11879	7,7 x 5,2	10	4,90
12879	5,0 x 3,0	10	4,60



Tischaufsteller 2er Set

table stands, 2 pcs. set
set 2 piezas, caballetes de mesa
set de 2, chevalets de table



	cm	↑ cm		€
00017	5,5 x 5	3,5	reserviert	3,80
00013	5,5 x 5	3,5	reserved	3,80
00572	5,5 x 5	3,5	smoking	5,00



Kartenhalter, 4er Set

table stands, 4 pcs. set
portatarjetas, set de 4
porte-cartes, set de 4



inkl. 30 Beschriftungskarten 10 x 8 cm (15x weiß, 15x schwarz)
incl. 30 lables 10 x 8 cm (15x white + 15x black)
incl. 30 tarjetas (15x blanco + 15x negro)
incl. 30 étiquettes (15x blanc + 15x noir)

	Ø cm	↑ cm	Farbe / Colour	pcs.	€/Set
71425	3	10	Marmor weiß / marble white	4	19,00
71427	3	10	Marmor grau / marble grey	4	19,00



Kartenhalter, 4er Set

table stands, 4 pcs. set
portatarjetas, set de 4
porte-cartes, set de 4



inkl. 30 Beschriftungskarten 10 x 8 cm (15x weiß, 15x schwarz)
incl. 30 lables 10 x 8 cm (15x white + 15x black)
incl. 30 tarjetas (15x blanco + 15x negro)
incl. 30 étiquettes (15x blanc + 15x noir)

	cm	↑ cm	Farbe / Colour	pcs.	€/Set
71426	3,5 x 3,5	10	Marmor weiß / marble white	4	19,00
71428	3,5 x 3,5	10	Marmor grau / marble grey	4	19,00



Beschriftungsetiketten

labeling labels
etiquetas
étiquettes



12 Bögen mit je 6 Motiven, selbstklebend, mit wasserlöslichem Stift beschreibbar
12 sheets includes 6 self-adhesive and removable labels, use regular chalkboard markers and wipe clean with a damp cloth
12 hojas, cada una con 6 motivos autoadhesivos, se pueden marcar con un rotulador lavable con agua
12 feuilles chacune avec 6 motifs autoadhésifs, on peut écrire avec un stylo lavable à l'eau

	cm	Farbe / Colour	€
00069	8,0 x 4,6	■	10,00



Kreide-Marker, Stärke 2mm, 2er Set

chalk marker, 2 pcs.
rotulador de tiza, 2 pz.
marqueur a la craie liquide, 2 pc.



Zum Gestalten und Beschriften von Tafeln, Glas und fast allen geschlossenen Oberflächen, deckende Flüssigkreide auf Wasserbasis, feucht abwischbar

For decorating and writing on boards, glass and almost all non-porous surfaces, opaque water-based liquid chalk, wet-wipeable

Rotuladores para pizarra de tiza líquida para decorar y escribir sobre pizarras, cristales y casi todas las superficies no porosas. Tiza líquida opaca al agua que se pueda borrar con un trapo

Pour décorations et inscriptions sur tableaux, verre et presque toutes les surfaces non poreuses, craie liquide opaque à base d'eau, effaçable avec un chiffon humide

	Ø cm	↑ cm	Farbe / Colour	pcs.	€/Set
71490	1	13	■	2	5,40
71491	1	13	■	2	5,40



Pfeffermühle „FRIDA“

pepper mill
molinillo de pimienta
moulin à poivre

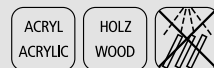

Mahlwerk aus Carbonstahl, Mahlgrad stufenlos einstellbar

mill in carbon steel, the grinding degree can be adjusted infinitely
molinillo de acero al carbono, el grado de molino se puede ajustar de modo continuo
moulin en acier de carbone, la finesse de mouture se peut régler de façon continue

	Ø cm	↑ cm	€
40549	6	15,5	16,00



Salzmühle „FRIDA“

salt mill
molinillo de sal
moulin à sel

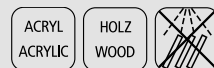

Mahlwerk aus Edelstahl, Mahlgrad stufenlos einstellbar

mill in stainless steel, the grinding degree can be adjusted infinitely
molinillo de acero inoxidable, el grado de molino se puede ajustar de modo continuo
moulin en acier inox, la finesse de mouture se peut régler de façon continue

	Ø cm	↑ cm	€
40550	6	15,5	16,00



Pfeffermühle „COPPER“

pepper mill
molinillo de pimienta
moulin à poivre



Mahlwerk aus Carbonstahl, Mahlgrad stufenlos einstellbar

mill in carbon steel, the grinding degree can be adjusted infinitely
molinillo de acero al carbono, el grado de molino se puede ajustar de modo continuo
moulin en acier de carbone, la finesse de mouture se peut régler de façon continue

	Ø cm	↑ cm	€
40551	6	15	14,90



Salzmühle „COPPER“

salt mill
molinillo de sal
moulin à sel



Mahlwerk aus Edelstahl, Mahlgrad stufenlos einstellbar

mill in stainless steel, the grinding degree can be adjusted infinitely
molinillo de acero inoxidable, el grado de molino se puede ajustar de modo continuo
moulin en acier inox, la finesse de mouture se peut régler de façon continue

	Ø cm	↑ cm	€
40552	6	15	14,90





Pfeffermühle „DIAMOND“

pepper mill
molinillo de pimienta
moulin à poivre



Mahlwerk aus Carbonstahl, Mahlgrad stufenlos einstellbar

mill in carbon steel, the grinding degree can be adjusted infinitely
molinillo de acero al carbono, el grado de molino se puede ajustar de modo continuo
moulin en acier de carbone, la finesse de mouture se peut réglée de façon continue

	Ø cm	↑ cm	€
40553	6	18	16,00



Salzmühle „DIAMOND“

salt mill
molinillo de sal
moulin à sel



Mahlwerk aus Edelstahl, Mahlgrad stufenlos einstellbar

mill in stainless steel, the grinding degree can be adjusted infinitely
molinillo de acero inoxidable, el grado de molino se puede ajustar de modo continuo
moulin en acier inox, la finesse de mouture se peut réglée de façon continue

	Ø cm	↑ cm	€
40554	6	18	16,00

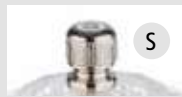

Pfeffermühle „GUNMETAL“

pepper mill
molinillo de pimienta
moulin à poivre



Mahlwerk aus Carbonstahl, Mahlgrad stufenlos einstellbar

mill in carbon steel, the grinding degree can be adjusted infinitely
molinillo de acero al carbono, el grado de molino se puede ajustar de modo continuo
moulin en acier de carbone, la finesse de mouture se peut réglée de façon continue

	Ø cm	↑ cm	€
40555	6	15,5	29,90



Salzmühle „GUNMETAL“

salt mill
molinillo de sal
moulin à sel



Mahlwerk aus Edelstahl, Mahlgrad stufenlos einstellbar

mill in stainless steel, the grinding degree can be adjusted infinitely
molinillo de acero inoxidable, el grado de molino se puede ajustar de modo continuo
moulin en acier inox, la finesse de mouture se peut réglée de façon continue

	Ø cm	↑ cm	€
40556	6	15,5	29,90





Pfeffermühle „ELEMENT“

pepper mill
molinillo de pimienta
moulin à poivre

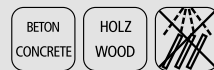

Mahlwerk aus Carbonstahl, Mahlgrad stufenlos einstellbar

mill in carbon steel, the grinding degree can be adjusted infinitely
molinillo de acero al carbono, el grado de molino se puede ajustar de modo continuo
moulin en acier de carbone, la finesse de mouture se peut régler de façon continue

	Ø cm	↑ cm	€
40557	7,5	15,5	21,00



Salzmühle „ELEMENT“

salt mill
molinillo de sal
moulin à sel

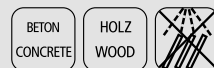

Mahlwerk aus Edelstahl, Mahlgrad stufenlos einstellbar

mill in stainless steel, the grinding degree can be adjusted infinitely
molinillo de acero inoxidable, el grado de molino se puede ajustar de modo continuo
moulin en acier inox, la finesse de mouture se peut régler de façon continue

	Ø cm	↑ cm	€
40558	7,5	15,5	21,00



Pfeffermühle „ELEMENT“

pepper mill
molinillo de pimienta
moulin à poivre

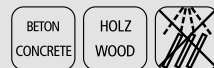

Mahlwerk aus Carbonstahl, Mahlgrad stufenlos einstellbar

mill in carbon steel, the grinding degree can be adjusted infinitely
molinillo de acero al carbono, el grado de molino se puede ajustar de modo continuo
moulin en acier de carbone, la finesse de mouture se peut régler de façon continue

	Ø cm	↑ cm	€
40538	6	18	23,00



Salzmühle „ELEMENT“

salt mill
molinillo de sal
moulin á sel

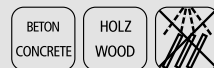

Mahlwerk aus Edelstahl, Mahlgrad stufenlos einstellbar

mill in stainless steel, the grinding degree can be adjusted infinitely
molinillo de acero inoxidable, el grado de molino se puede ajustar de modo continuo
moulin en acier inox, la finesse de mouture se peut régler de façon continue

	Ø cm	↑ cm	€
40539	6	18	23,00





Pfeffermühle
pepper mill
molinillo de pimienta
moulin à poivre



Mahlwerk aus Carbonstahl, Mahlgrad stufenlos einstellbar
mill in carbon steel, the grinding degree can be adjusted infinitely
molinillo de acero al carbono, el grado de molino se puede ajustar de modo continuo
moulin en acier de carbone, la finesse de mouture se peut réglée de façon continue

	Ø cm	↑ cm	Farbe / Colour	€
40559	5,5	18		29,90



Salzmühle
salt mill
molinillo de sal
moulin à sel



Mahlwerk aus Edelstahl, Mahlgrad stufenlos einstellbar
mill in stainless steel, the grinding degree can be adjusted infinitely
molinillo de acero inoxidable, el grado de molino se puede ajustar de modo continuo
moulin en acier inox, la finesse de mouture se peut réglée de façon continue

	Ø cm	↑ cm	Farbe / Colour	€
40560	5,5	18		29,90



Pfeffer- u. Salzmühle „PROFESSIONAL“
salt / pepper mill
molinillo de sal / pimienta
moulin à sel / poivre



Mahlgrad stufenlos einstellbar
the grinding degree can be adjusted infinitely
el grado de molino se puede ajustar de modo continuo
la finesse de mouture se peut réglée de façon continue

	Ø cm	↑ cm	Farbe / Colour		€
40540	5,5	15		pepper mill	18,00
40541	5,5	15		salt mill	18,00



Pfeffermühle „PROFESSIONAL VINTAGE“
pepper mill
molinillo de pimienta
moulin à poivre



Deutsches Buchenholz, vintage, Mahlwerk aus Carbonstahl, Mahlgrad stufenlos einstellbar
German beechwood, vintage, mill in carbon steel, the grinding degree can be adjusted infinitely
madera de haya alemana, carácter „vintage“, molinillo de acero al carbono, el grado de molino se puede ajustar de modo continuo
bois de hêtre d'Allemagne, vintage, moulin en acier de carbone, la finesse de mouture se peut réglée de façon continue

	Ø cm	↑ cm	Farbe / Colour	€
40535	5,5	15		22,00
40537	6	23		26,00
40546	5,5	15		22,00
40548	6	23		26,00



Salzmühle „PROFESSIONAL VINTAGE“

salt mill
molinillo de sal
moulin à sel



Deutsches Buchenholz, vintage, Mahlwerk aus Edelstahl, Mahlgrad stufenlos einstellbar
German beechwood, vintage, mill in stainless steel, the grinding degree can be adjusted infinitely

madera de haya alemana, carácter „vintage“, molinillo de acero inoxidable, el grado de molino se puede ajustar de modo continuo

bois de hêtre d'Allemagne, vintage, moulin en acier inox, la finesse de mouture se peut réglée de façon continue

	Ø cm	↑ cm	Farbe / Colour	€
40536	5,5	15		22,00
40547	5,5	15		22,00



Pfeffermühle „PROFESSIONAL“

pepper mill
molinillo de pimienta
moulin à poivre



Mahlwerk aus Carbonstahl, Mahlgrad stufenlos einstellbar

mill in carbon steel, the grinding degree can be adjusted infinitely

molinillo de acero al carbono, el grado de molino se puede ajustar de modo continuo

moulin en acier de carbone, la finesse de mouture se peut réglée de façon continue

	Ø cm	↑ cm	Farbe / Colour		€
40530	5,5	15		Holz / wood	20,90
40532	7,0	30		Holz / wood	31,00
40534	7,0	40		Holz / wood	52,00



Mahlgrad einstellbar
grinder setting

	Ø cm	↑ cm	Farbe / Colour		€
40520	5,5	15		Holz / wood	20,90
40522	7,0	30		Holz / wood	31,00
40524	7,0	40		Holz / wood	52,00



Mahlgrad einstellbar
grinder setting



Salzmühle „PROFESSIONAL“

salt mill
molinillo de sal
moulin à sel



Mahlwerk aus Edelstahl, Mahlgrad stufenlos einstellbar

mill in stainless steel, the grinding degree can be adjusted infinitely

molinillo de acero inoxidable, el grado de molino se puede ajustar de modo continuo

moulin en acier inox, la finesse de mouture se peut réglée de façon continue

	Ø cm	↑ cm	Farbe / Colour		€
40531	5,5	15		Holz / wood	20,90
40521	5,5	15		Holz / wood	20,90



Tablett

tray
bandeja
plateau

mit 2 Absätzen Ø 6 cm
with 2 holes Ø 6 cm
con 2 agujeros Ø 6 cm
avec 2 trous Ø 6 cm



	cm	↑ cm	€
84039	16,5 x 8,5	1,5	3,50



Naturschieferplatte / Untersetzer

natural slate tray
bandeja de pizarra natural
plateau ardoise naturelle

mit 2 Absätzen Ø 6 cm
with 2 holes Ø 6 cm
con 2 agujeros Ø 6 cm
avec 2 trous Ø 6 cm



	cm	* mm	€
00971	15 x 8	6 - 9	3,00



2 in 1 Salz- u. Pfeffermühle

2 in 1 salt / pepper mill
2 in 1 molinillo de sal / pimienta
2 in 1 moulin à sel / poivre

Keramik Mahlwerk
ceramic mechanism
molinillo de cerámica
broyeur en céramique



	Ø cm	↑ cm	€
40545	7,5	18,5	19,00



Mahlgrad einstellbar
grinder setting

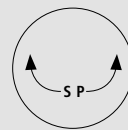

2 in 1 Salz- u. Pfeffermühle

2 in 1 salt / pepper mill
2 in 1 molinillo de sal / pimienta
2 in 1 moulin à poivre / sel

Keramik Mahlwerk
ceramic mechanism
molinillo de cerámica
broyeur en céramique



	cm	↑ cm	€
40544	6 x 4,5	9,5	17,00



Mahlgrad einstellbar
grinder setting

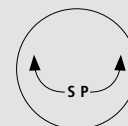



Käse- oder Gewürzstreuer

spice shaker
botes especieros
saupoudreuse à épices

Löcher Ø 5 mm, inkl. Staubdeckel
holes Ø 5 mm, incl. cover
agujeros Ø 5 mm, tapa plástico
trous Ø 5 mm, couvercle plastique



	Ø cm	↑ cm	ltr.	€
00775	5,5	7,5	0,15	5,40



Netzstreuer

mesh top shaker
polvoreador, tapa con malla fina
pot à épices, couvercle toile fine

inkl. Staubdeckel
incl. cover
tapa plástico
couvercle plastique



	Ø cm	↑ cm	ltr.	€
00776	5,5	7,5	0,15	5,40



Streuer fein

small hole shaker
polvoreador, tapa con agujeros pequeños
pot à épices, couvercle à petits trous

Löcher Ø 1 mm, inkl. Staubdeckel
holes Ø 1 mm, incl. cover
agujeros Ø 1 mm + tapa plástico
trous Ø 1 mm + couvercle plastique



	Ø cm	↑ cm	ltr.	€
00777	5,5	7,5	0,15	4,90



Streuer grob

large hole shaker
polvoreador, tapa con agujeros grandes
pot à épices, couvercle à grands trous

Löcher Ø 2,5 mm, inkl. Staubdeckel
holes Ø 2,5 mm, incl. cover
agujeros Ø 2,5 mm + tapa plástico
trous Ø 2,5 mm + couvercle plastique



	Ø cm	↑ cm	ltr.	€
00778	5,5	7,5	0,15	4,90



Multistreuer
multi-functional shaker
salero
saupoudreuse



	Ø cm	↑ cm	ltr.	€
00774	7	12	0,20	12,00



geschlossen



Ø 2 mm



Ø 4 mm



Ø 6 mm



Multistreuer
multi-functional shaker
salero
saupoudreuse



	Ø cm	↑ cm	ltr.	€
00773	6	8	0,05	8,00



geschlossen



Ø 2 mm



Ø 4 mm



Ø 6 mm



Netzstreuer
mesh top shaker
polvoreador, tapa con malla fina
pot à épices, couvercle toile fine



	Ø cm	↑ cm	ltr.	€
00781	6,5	12	0,20	11,00



00782

00783

Multistreuer / Gewürzstreuer
multi-functional shaker
juego dosificador
jeu de salières



	Ø cm	↑ cm	ltr.	€
00782	6,5	12	0,20	10,00

00783	6,5	12	0,20	mit 8 Löchern / with 8 holes con 8 agujeros / avec 8 trous	10,00
-------	-----	----	------	---	-------



00782 - Ø 2 mm



00783 - Ø 8 mm

Tableware . Table Presentation



Salz- und Pfefferstreuer, 2er Set

salt - and pepper shaker, 2 pcs. set
juego de 2 piezas de sal y pimienta
set sel et poivre, 2 pz.



	Ø cm	↑ cm	pcs.		€
40500	5	6,5	2	glatte Ausführung / smooth version versión recta / forme lisse	2,40
40501	5	6,5	2	geriffelte Ausführung / fluted version versión ondulada / forme ondulée	2,40
40507	6	10	2		8,60



Allzweckstreuer, 12er Set

shaker, 12 pcs set
juego 12 piezas dosificador
jeu de 12 salières/poivrières



	cm	↑ cm	pcs.		€
40504	4 x 4	10	12	13 Löcher / 13 holes 13 agujeros / 13 trous	20,00
40505	4 x 4	10	12	3 Löcher / 3 holes 3 agujeros / 3 trous	16,00



Ministreuer, 4er Set

smaller shaker, 4 pcs. Set
juego de 4 piezas bodegas pequeñas
jeu de 4 mini-salières



	Ø cm	↑ cm	pcs.		€
40503	3,5	4	4		4,00



Salzstreuer

salt shaker
salero
salière



Pommes-Frites Streuer mit Schraubkappe
for french fries, cover to screw
para patatas fritas, tapa de rosca
pour les frites, couvercle à visser

	Ø cm	↑ cm		€
00779	8	17	Aluminium / aluminium aluminio / aluminium	8,90
00772	8	17	Edelstahl / stainless steel acero inoxidable / inox	11,40



Pfeffer- & Salz-Menage „WOOD“

salt- and pepper-menage
salero-pimentero
ménage sel et poivre



matt poliert, Glasbehälter mit Edelstahl-Deckel und Deckelverschluss
satin polished finish, glass with stainless steel cover
pulido acabado efecto satinado, cristal con tapa de acero inoxidable
verre et inox mat satiné

	cm	↑ cm	€
40435	11,5 x 5,5	17	16,00



Essig- & Öl-Menage „WOOD“

oil- and vinegar-menage
aceitera-vinagrera
ménage huile et vinaigre



matt poliert, Glasbehälter mit Edelstahl-Deckel und Deckelverschluss
satin polished finish, glass with stainless steel cover
pulido acabado efecto satinado, cristal con tapa de acero inoxidable
verre et inox mat satiné

	cm	↑ cm	€
40436	16 x 7,5	24,5	24,00



Pfeffer-, Salz-, Essig- und Öl-Menage „WOOD“

salt- and pepper- and oil- and vinegar-menage
salero-pimentero & aceitera-vinagrera
ménage sel et poivre & huile et vinaigre



matt poliert, möbelschonende Unterseite
satin polished finish, glass with stainless steel cover
pulido acabado efecto satinado, con tapa de acero inoxidable
verre et inox mat satiné, avec couvercle inox

	cm	↑ cm	€
40437	15,5 x 12	24,5	32,00

Salz- und Pfefferstreuer / salt - and pepper shaker / juego de sal y pimienta / set sel et poivre

	Ø cm	↑ cm		€
40438	4	9	6 Löcher - Ø 1,85 mm	3,40
40439	4	9	18 Löcher - Ø 1,35 mm	3,40

Ersatzglas Essig / Öl / spare glass vinegar / oil / cristal de recambio con tapa „aceite & vinagre“
verre huile ou vinagre

	Ø cm	↑ cm	ltr.	€
40442	6	18,5	0,2	4,40



praktischer Ausgießer
no drips pourer



NEW

Pfeffer- und Salz-Menage „ELEMENT“

salt- and pepper-menage
salero-pimentero
ménage sel et poivre



Beton-Ständer, Glasbehälter mit Edelstahl-Deckel, möbelschonende Unterseite

stand made of concrete, glass with stainless steel cover, furniture-friendly underside
soporte de hormigón, recipiente de vidrio con tapa de acero inoxidable, con base anti rayaduras

support en béton, récipient en verre avec couvercle en acier inox, avec revêtement antirayures

	cm	↑ cm	€
40410	10 x 6	17	16,00



NEW

Essig- und Öl-Menage „ELEMENT“

oil- and vinegar-menage
aceitera-vinagrera
ménage huile et vinaigre



Beton-Ständer, Glasbehälter mit Edelstahl-Deckel und tropffreiem Kunststoff-Ausgießer, möbelschonende Unterseite

stand made of concrete, glass with stainless steel cover and non-drip nozzle-spout, furniture-friendly underside

soporte de hormigón, recipiente de vidrio con tapa de acero inoxidable y sistema antigoteo, con base anti rayaduras

support en béton, récipient en verre avec couvercle en acier inox et verseur antigoutte, avec revêtement antirayures

	cm	↑ cm	€
40411	14 x 8	25	24,00



NEW

Pfeffer-, Salz-, Essig- und Öl-Menage „ELEMENT“

salt- and pepper- and oil- and vinegar-menage
salero-pimentero & aceitera-vinagrera
ménage sel et poivre & huile et vinaigre



Beton-Ständer, Glasbehälter mit Edelstahl-Deckel und Drehverschluss, möbelschonende Unterseite

stand made of concrete, glass with stainless steel cover and screw cap, furniture-friendly underside

soporte de hormigón, recipiente de vidrio con tapa de acero inoxidable y tapón de rosca, con base anti rayaduras

support en béton, récipient en verre avec couvercle en acier inox et bouchon à vis, avec revêtement antirayures

	cm	↑ cm	€
40412	12,5 x 12,5	25	34,00



NEW

Pfeffer-, Salz-, Essig- und Öl-Menage „ELEMENT“

salt- and pepper- and oil- and vinegar-menage
salero-pimentero & aceitera-vinagrera
ménage sel et poivre & huile et vinaigre



Beton-Ständer mit Kartenhalterung, Glasbehälter mit Edelstahl-Deckel und Drehverschluss, möbelschonende Unterseite

stand made of concrete with card holder, glass with stainless steel cover and screw cap, furniture-friendly underside

soporte de hormigón con tarjetero, recipiente de vidrio con tapa de acero inoxidable y tapón de rosca, con base anti rayaduras

support en béton avec porte-cartes, récipient en verre avec couvercle en acier inox et bouchon à vis, avec revêtement antirayures

	cm	↑ cm	€
40413	14 x 13,5	20	34,00



mit Kartenhalterung an der Rückseite
with card holder at the back



Pfeffer- & Salz-Menage „CLASSIC“

salt- and pepper-menage
salero-pimentero
ménage sel et poivre



Glasbehälter mit Edelstahl-Deckel und Drehverschluss

glass with stainless steel cover
vidrio con tapa de acero inoxidable con rosca
en verre avec couvercle inox à visser

	cm	↑ cm	€
40310	10,5 x 6,5	16	16,90



Pfeffer- & Salz-Menage „CLASSIC“

salt- and pepper-menage
salero-pimentero
ménage sel et poivre



Glasbehälter mit Edelstahl-Deckel und Drehverschluss

glass with stainless steel cover
vidrio con tapa de acero inoxidable con rosca
en verre avec couvercle inox à visser

	Ø cm	↑ cm	€
40320	10,5	16	21,00



Menage „CLASSIC“

menage
menage
ménage



Glasbehälter mit Edelstahl-Deckel und tropffreiem Kunststoff-Ausgießer

with stainless steel cover and non-drip nozzle-spout
vidrio con tapa inox y sistema antigoteo
verre avec couvercle inox et verseur antigoutte

	cm	↑ cm	ltr.	€
40440	14,5 x 8,5	23	0,2	25,00
40450	17,5 x 10,5	23		28,50

Ersatzglas mit Deckel / spare glass with cover / vidrio con tapa / verre + couvercle

	Ø cm	↑ cm	€	
40312	4	9	18 Löcher - Ø 1,35 mm	3,40
40311	4	9	6 Löcher - Ø 1,85 mm	3,40

Ersatzglas mit Deckel „Essig & Öl“ / spare glass with cover „vinegar & oil“ / cristal de recambio con tapa „vinegar & oil“ / verre huile ou vinaige avec couvercle inox et verseur antigoutte

	Ø cm	↑ cm	ltr.	€
40441	6	18,5	0,2	4,50

Ersatzglas mit Deckel „Zahnstocher“ / spare glass with cover „toothpick“ / porta-palillos vidrio con tapa / verre à cure-dents + couvercle

	Ø cm	↑ cm	€
40313	4	9	3,40



Senftöpfchen, 2er Set

mustard glass, 2 pcs. set
juego 2 piezas vasos mostaza
jeu de 2 verres à moutarde



inkl. Löffel und Edelstahl-Deckel

incl. spoons and covers
incluye cucharas y tapas
cuillères et couvercles inclus

	Ø cm	↑ cm	pcs.	€
40415	5	6	2	5,00



Menage „ECONOMIC“

menage
menage
ménage



Glasbehälter mit Edelstahl-Deckel und Drehverschluss

glass with stainless steel cover
cristal con tapa inox a rosca
en verre avec couvercle inox à visser

	cm	↑ cm	€
40455	8 x 4	13	4,20



Menage „ECONOMIC“

menage
menage
ménage



Glasbehälter mit Edelstahl-Deckel und Drehverschluss

glass with stainless steel cover
cristal con tapa inox a rosca
en verre avec couvercle inox à visser

	cm	↑ cm	€
40457	8 x 8	12	6,40

Glas für Senf / glass for mustard / vaso de cristal para mostaza / pot verre seul pour la moutarde

	€
40464	1,60



Menage „ECONOMIC“

menage
menage
ménage



Glasbehälter mit Edelstahl-Deckel und tropffreiem Kunststoff-Ausgießer

glasses with stainless steel cover and non-drip nozzle-spout
cristales con tapa de acero inoxidable y sistema antigoteo
en verre avec couvercle inox et insert plastique antigoutte

	cm	↑ cm	€
40458	11,5 x 5,5	22	8,20
40460	11 x 10,5	22	12,40

Pfeffer- oder Salz-Glasstreuer / pepper- or salt-glass with cover salero o pimentero de cristal con tapa / salière ou poivrière seule en verre avec couvercle inox

	Ø cm	↑ cm	€
40461	3	9	1,80

Essig- oder Öl-Glasbehälter / oil- or vinegar-glass with cover / aceitera-vinagrera con tapa bouteille huile ou vinaigre seule en verre et couv. inox

	Ø cm	↑ cm	€
40462	4,5	16	3,10

Glas für Zahnstocher / glass for tooth picks / vaso de cristal para palillos de dientes porte-cure-dents en verre

	Ø cm	↑ cm	€
40463	3	6	1,10



40476



40478



40480

Menage „PRO“

menage
menage
ménage



matt poliert, Glasbehälter mit Edelstahl-Deckel und tropffreiem Kunststoff-Ausgießer

satin polished finish, glass with stainless steel cover and non-drip nozzle-spout

inox satinado, vidrio, sistema antigoteo

inox poli mat satiné et verre, insert plastique antigoutte

	cm	↑ cm	€
40476	12,0 x 8,0	19	10,60
40478	12,5 x 11,0	19	15,00
40480	13,0 x 11,0	19	15,70

Pfeffer- oder Salz-Glasstreuer / pepper- or salt-glass with cover / salero o pimentero de cristal con tapa
salière ou poivrière seule en verre avec couvercle inox

	Ø cm	€
40461	14	1,80

Essig- oder Öl-Glasbehälter / oil- or vinegar-glass with cover / aceiteira-vinagrera con tapa
bouteille huile ou vinaigre seule en verre et couv. inox

	Ø cm	€
40462	14	3,10



40470



40472



40474

Menage „PRO“

menage
menage
ménage



matt poliert, Glasbehälter mit Edelstahl-Deckel und Drehverschluss

satin polished finish, glass with stainless steel cover

inox satinado, vidrio y tapas con rosca

inox poli mat satiné et verre, couvercle à visser

	cm	↑ cm	€
40470	8,5 x 5,7	11,5	5,40
40472	9,2 x 8,5	11,5	6,80
40474	10 x 10	11,5	7,60

Tableware . Table Presentation



Parmesan-Menage „CLASSIC“

cheese dish
quesera parmesano
service à parmesan

hochglanzpoliert, inkl. Löffel
mirror polished finish, with spoon
pulido efecto espejo, con bol cristal y cuchara
brillant, avec bol verre et cuillère



	Ø cm	↑ cm	€
40330	10,5	7	16,50

Ersatzbehälter / sparecontainer / bol de recambio / bol de rechange

	Ø cm	€
40331	10,5	4,50



Parmesan-Menage „PROFI“

cheese dish
quesera parmesano
service à parmesan



	Ø cm	↑ cm	€
40424	9	5,5	13,50

Ersatzbehälter / sparecontainer / bol de recambio / bol de rechange

	Ø cm	€
40331	10,5	4,50



Parmesan-Menage „PRO“

cheese dish
quesera parmesano
service à parmesan

matt poliert, inkl. Löffel
satin polished finish, with spoon
pulido mate satinado, con bol cristal y cuchara
mat satiné, avec bol verre et cuillère



	Ø cm	↑ cm	€
40482	10,5	13	8,80

Ersatzbehälter / sparecontainer / bol de recambio / bol de rechange

	Ø cm	€
40331	10,5	4,50



Parmesan-Menage „ECONOMIC“

cheese dish
quesera parmesano
service à parmesan

inkl. Kunststofflöffel
with spoon
con cuchara
avec cuillère



	Ø cm	↑ cm	€
40453	10,5	7	5,70

Ersatzbehälter / sparecontainer / bol de recambio / bol de rechange

	Ø cm	€
40454	10,5	2,10



Essig- & Öl-Menage
oil- and vinegar-menage
aceitera-vinagrera
ménage huile et vinaigre



Glasbehälter mit Deckel und tropffreiem PE-Ausgießer

glass with lid and non-drip nozzle-spout

recipiente de cristal con tapa y sistema antigoteo

pot en verre avec couvercle et système plastique antigoutte

	cm	↑ cm	ltr.	€
40445	10,5 x 5,5	24	0,12	9,00
40446	13,0 x 7,0	34	0,50	12,00



tropffreier Ausgießer
non-drip spout



250 ml

Ständer
serving stand
soporte 2 botellas
support 2 bouteilles



matt poliert, passend für handelsübliche 500 ml Flaschen, Lieferung ohne Flaschen

satin polished finish, for standard bottles with 500 ml content, delivery without bottles

inox satinado, para botellas estándar de 500 ml, se entrega sin botellas

inox mat satiné, pour bouteilles standard de 500 ml, livré sans bouteilles

	cm	↑ cm	€
40443	13,0 x 7,0	30	18,90



Gewürzständer
serving stand/rack
soporte salsas y condimentos
porte condiments et sauces



matt poliert, Lieferung ohne Deko

satin polished finish

acabado pulido efecto satinado

poli mat satiné

	Ø cm	↑ cm	€
40300	19	20	19,50



Menage
menage
menage
ménage



drehbares Gestell, Glasbehälter mit Edelstahl-Deckel und Drehverschluss

rotating frame, glass with stainless steel cover

soporte giratorio con piezas de vidrio y tapas inox

tournant, avec pièces en verre et couvercle inox

	Ø cm	↑ cm	€
40485	16	20	18,00



93308

93309

Spritzflasche inklusive Ausgießer

squeeze bottle with nozzle
botella exprimible con dosificador
flacon pulvérisateur avec bec verseur

ideal für Bitter-Liköre, Essig, Öl

perfect for bitter liqueur, vinegar, oil

perfecto para amargo licor, vinagre, aceite

pour amaro liqueure, vinaigre, huile



	cm	↑ cm	ltr.	€
93308	6 x 5	20	0,2	9,00

Ausgießer passend für Spritzflasche / nozzle suitable for squeeze bottle / dosificador apto para botella exprimible / bec verseur approprié pour flacon pulvérisateur

	Ø cm	↑ cm	€
93309	2,5	5,5	2,60



300 ml

Zuckerdosierer

sugar dispenser
azucarero
sucrier

Schraubdeckel aus Edelstahl

cover stainless steel

tapa inoxidable

couvercle inox



	Ø cm	↑ cm	ltr.	€
00766	8,5	15	0,3	3,50

Ersatzglasbehälter / spare glas-container / contenedor de repuesto / récipient verre de rechange

	€
00768	1,80



40490
150 ml

40494
250 ml

Zuckerdosierer

sugar dispenser
azucarero
sucrier

Schraubdeckel aus Edelstahl, mit Dosierrohr

cover stainless steel with dosingtube

tapa inoxidable y tubo dosificador

couvercle inox et tube doseur



	Ø cm	↑ cm	ltr.	€
40490	8,5	12	0,15	2,90
40494	8	15	0,25	2,90

Ersatzglasbehälter / spare glas-container / contenedor de repuesto / récipient verre de rechange

	fits to	€
40498	40490	1,60
40499	40494	1,60

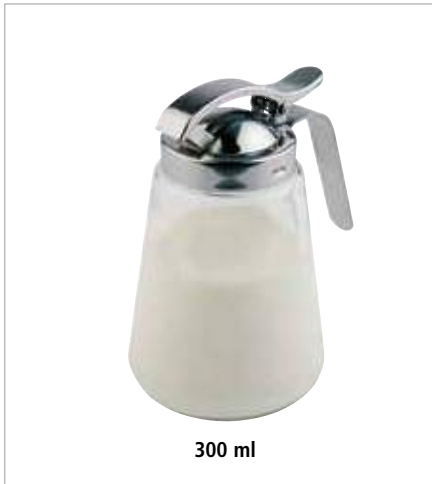

300 ml

Allzweckgießer

pourer
bote vertedor universal
pot verseur universel

für Honig, Kaffeesahne, etc., Schraubdeckel aus Edelstahl

for honey, cream, etc., cover stainless steel
para miel, crema, etc., tapa inoxidable
pour le miel, le lait, la crème, etc., couvercle inox



	Ø cm	↑ cm	ltr.	€
00765	8,5	13,5	0,3	6,60

Ersatzglasbehälter / spare glas-container / contenedor de repuesto / récipient verre de rechange

	Ø cm	↑ cm	ltr.	€
00768				1,80



250 ml

Allzweckgießer

pourer
dosificador
doseur

Schraubdeckel aus Edelstahl und Kunststoff, mit Dosierklappe

cover stainless steel and plastic, with dosing flap
acero inoxidable y tapa plástico, con cierre dosificador
couvercle en inox et plastique, avec couvercle doseur



	Ø cm	↑ cm	ltr.	€
40488	8	12,5	0,25	5,60



250 ml

Zuckerdosierer

sugar dispenser
azucarero
sucrier

Schraubdeckel aus Edelstahl, mit Dosierrohr

cover stainless steel, with dosing tube
tapa inoxidable y tubo, con cierre dosificador
couvercle inox et tube doseur



	Ø cm	↑ cm	ltr.	€
40486	8	15	0,25	2,90



320 ml

Zuckerdosierer

sugar dispenser
azucarero
sucrier

Schraubdeckel aus Edelstahl, mit Dosierrohr

cover stainless steel, with dosing tube
tapa inoxidable y tubo, con cierre dosificador
couvercle inox et tube doseur



	Ø cm	↑ cm	ltr.	€
40506	7,5	17,0	0,32	4,20



320 ml

Zuckerdosierer

sugar dispenser
azucarero
sucrier



Schraubdeckel mit Klappe aus Edelstahl, mit Dosierklappe

cover stainless steel, with dosing flap
tapa acero inoxidable, con cierre dosificador
couvercle inox, avec couvercle doseur

	Ø cm	↑ cm	ltr.	€
40487	7,5	13,5	0,32	3,60



200 ml

Zuckerdosierer

sugar dispenser
azucarero
sucrier



mit Schraubverschluss, Dosier-Rohr Ø 15 mm

cover and dosingtube Ø 15 mm
con tapa y tubo dosificador Ø 15 mm
couvercle avec tube doseur Ø 15 mm

	Ø cm	↑ cm	ltr.	€
40508	6,5	14,5	0,20	9,90



10316
170 ml

10317
170 ml

Zuckerspender / Milchkännchen

sugar pourer / milk jug
dispensador de azúcar
sucrier doseur



matt poliert

satín polished finish
pulido efecto satinado
intérieur et extérieur poli mat

	Ø cm	↑ cm	ltr.	€
10316	5	15	0,17	8,60
10317	5	11,5	0,17	6,00



Zuckerkuigel

sugar pot
azucarero
sucrier



hochglanzpoliert, mit Rolldecke

mirror polished finish, rolltop cover
pulido acabado brillante, tapa abatible
brillant, couvercle abattant

	Ø cm	↑ cm	€
00033	13,5	15	10,90



Butterservierer

butter dish
mantequillera
beurrier

hochglanzpoliert
mirror polished finish
acabado brillante
poli brillant



	Ø cm	↑ cm	€
15921	9	7	12,60



Butterservierer

butter dish
mantequillera
beurrier



	Ø cm	↑ cm	€
15925	9	9	7,00



Butterservierer

butter dish
mantequillera
beurrier



	cm	↑ cm	€
15926	9 x 9	9	7,00



Schale „ENAMELWARE“

bowl
cuenco
bol



	cm	↑ cm	€
40667	16 x 12	3,5	6,60
40668	18 x 13,5	4,0	6,90



Kühlschrank-Butterdose

refrigerator butter dish
mantequillera para nevera
boîte à beurre pour le frigo



	cm	↑ cm	€
00063	16 x 9,5	5,5	2,50



Eierbecher

egg holder
huevera
coquetier



	Ø cm	↑ cm	€
00032	8,5	2	1,60

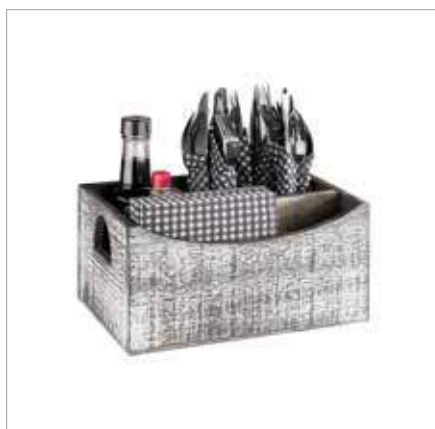

Table Caddy „VINTAGE“

table caddy
caddy de mesa
caddy de table



unterteilt in 5 Fächer
divided into 5 compartments
dividido en 5 compartimentos
divisé en 5 compartiments

	cm	↑ cm	€
11608	22,0 x 15,5	11,5	19,00



Table Caddy „VINTAGE“

table caddy
caddy de mesa
caddy de table



unterteilt in 7 Fächer
divided into 7 compartments
dividido en 7 compartimentos
divisé en 7 compartiments

	cm	↑ cm	€
11609	25,5 x 15,5	11,5	19,00



Table Caddy „VINTAGE“

table caddy
caddy de mesa
caddy de table



unterteilt in 4 Fächer, mit Tragegriff
divided into 4 compartments, with handle
dividido en 4 compartimentos, con asa
divisé en 4 compartiments, avec poignée

	cm	↑ cm	€
11610	22,0 x 15,5	22,0	19,00



Table Caddy „VINTAGE“

table caddy
caddy de mesa
caddy de table



	cm	↑ cm	€
11612	15,0 x 15,0	10	9,00
11613	15,0 x 15,0	15	12,00

	cm	↑ cm	€
11614	30,0 x 15,0	15	14,00

GN 1/1 Tablett / GN tray / GN bandeja / GN plateau



	cm	↑ cm	GN	€
11615	53,0 x 32,5	5	1/1	16,00

Buffettisch „MINI VINTAGE“

buffet stand
soporte para buffet
présentoir buffet



	cm	↑ cm	fits to	€
11634	40,0 x 21,5	15	GN 1/3 trays	19,00



VINTAGE



Holzbox „VINTAGE“

woodbox
caja madera
base bois



Schubladenoptik, mit Knopf

drawer look, with knob
look cajón, con pomo
look tiroir, avec bouton

	cm	↑ cm		€
11631	18,5 x 18,5	11	Innenmaß: 17 x 17 cm, mit Beschriftungsfach	13,00
11630	11,5 x 7,5	5	Innenmaß: 10 x 6 cm	4,00



Holzbox „VINTAGE“

woodbox
caja madera
base bois



Schubladenoptik, mit Knopf

drawer look, with knob
look cajón, con pomo
look tiroir, avec bouton

	cm	↑ cm		€
11633	18,5 x 18,5	11	Innenmaß: 17 x 17 cm, mit Beschriftungsfach	13,00
11632	11,5 x 7,5	5	Innenmaß: 10 x 6 cm	4,00



Table Caddy „VINTAGE“

table caddy
caddy de mesa
caddy de table



herausnehmbare Aufteilung, 4-Fächer (7 x 7 cm)
separation removable, 4 compartments (7 x 7 cm)
separadores amovibles, 4 compartimentos (7 x 7 cm)
séparateurs amovibles, 4 compartiments (7 x 7 cm)

	cm	↑ cm	Farbe / Colour	€
11635	17 x 17	10	White	18,00
11636	17 x 17	10	Blue	18,00
11637	17 x 17	10	Yellow	18,00



Table Caddy „VINTAGE“

table caddy
caddy de mesa
caddy de table



herausnehmbare Aufteilung, 4-Fächer (7 x 7 cm)
separation removable, 4 compartments (7 x 7 cm)
separadores amovibles, 4 compartimentos (7 x 7 cm)
séparateurs amovibles, 4 compartiments (7 x 7 cm)

	cm	↑ cm	Farbe / Colour	€
11600	17 x 17	16	White	20,00
11601	17 x 17	16	Blue	20,00
11602	17 x 17	16	Yellow	20,00



Table Caddy „VINTAGE“

table caddy
caddy de mesa
caddy de table



herausnehmbare Aufteilung, 6 Fächer (7,5 x 7,5 cm)
separation removable, 6 compartments (7,5 x 7,5 cm)
separadores amovibles, 6 compartimentos (7,5 x 7,5 cm)
séparateurs amovibles, 6 compartiments (7,5 x 7,5 cm)

	cm	↑ cm	Farbe / Colour	€
11638	27 x 17	10	White	22,00
11639	27 x 17	10	Blue	22,00
11640	27 x 17	10	Yellow	22,00



Table Caddy „VINTAGE“

table caddy
caddy de mesa
caddy de table



herausnehmbare Aufteilung, 6 Fächer (7,5 x 7,5 cm)
separation removable, 6 compartments (7,5 x 7,5 cm)
separadores amovibles, 6 compartimentos (7,5 x 7,5 cm)
séparateurs amovibles, 6 compartiments (7,5 x 7,5 cm)

	cm	↑ cm	Farbe / Colour	€
11603	27 x 17	16	White	24,00
11604	27 x 17	16	Blue	24,00
11605	27 x 17	16	Yellow	24,00

WOODY



stapelbar / stackable
apilables / empilable



Holzbox „WOODY“

woodbox
caja madera
base bois

Akazienholz
acacia wood
madera de acacia
bois d'acacia



	cm	↑ cm		€
11650	15,0 x 15,0	5,5	Innenmaß: 13 x 13 cm	11,00
11651	22,5 x 15,0	5,5	Innenmaß: 13,5 x 13 / 6,5 x 13 cm	14,00

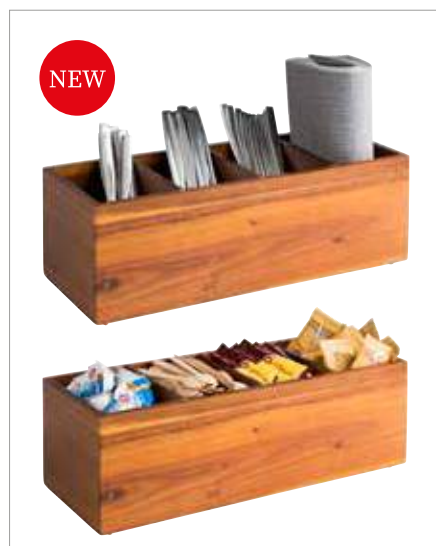

NEW

Holzbox „WOODY“

woodbox
caja madera
base bois

Akazienholz, 4-Fächer
acacia wood, 4 compartements
madera de acacia, 4 compartimentos
bois d'acacia, 4 compartiments



	cm	↑ cm		€
11649	36 x 14	12,5		12,00



NEW

Table Caddy „ELEMENT“

table caddy
caddy de mesa
caddy de table



Beton, mit möbelschonender Unterseite
concrete, furniture-friendly underside
hormigón, con base anti rayaduras
béton, avec revêtement antirayures

	cm	↑ cm		€
11647	16,5 x 16,0	6,5	Innenmaß: 14,5 x 14 cm	9,90



NEW

Table Caddy „ELEMENT“

table caddy
caddy de mesa
caddy de table



Beton, mit möbelschonender Unterseite, 2 Löcher je 6,5 cm
concrete, furniture-friendly underside, 2 holes each 6.5 cm
hormigón, con base anti rayaduras, 2 agujeros cada uno 6,5 cm
béton, avec revêtement antirayures, 2 trous de 6,5 cm chacun

	cm	↑ cm		€
11648	23,5 x 16,0	6,5	Innenmaß: 14,5 x 14 cm	14,90



Table Caddy

table caddy
caddy de mesa
caddy de table



Akazienholz
acacia wood
madera de acacia
bois d'acacia

	cm	↑ cm		€
11625	23 x 10	10	Innenmaß: 22,5 x 6 cm	14,90



Table Caddy „VINTAGE“

table caddy
caddy de mesa
caddy de table



Holz, 2-Fächer (13,5 x 6 cm)
2 compartments (13,5 x 6 cm)
2 compartimentos (13,5 x 6 cm)
2 compartiments (13,5 x 6 cm)

	cm	↑ cm		€
40404	15,5 x 15,5	15	Innenmaß: 13,5 x 6 cm	16,00



Table Caddy

table caddy
caddy de mesa
caddy de table



Akazienholz, 2-Fächer
acacia wood, 2 compartements
madera de acacia, 2 compartimentos
bois d'acacia, 2 compartiments

	cm	↑ cm		€
40405	25 x 15	18	Innenmaß: 21,5 x 8 cm	29,00

Tableware . Table Presentation



Kerzenleuchter

candle holder
candelabro
chandelier



hochwertige Gastro Ausführung, möbelschonende Unterseite

heavy quality, with non-scratching undersurface

alta calidad, con base antirralladuras

haute qualité, avec base revêtue antirayures

	cm	↑ cm		€
04001	27,5 x 27,5	25	5-flammig / 5-lids / 5 ramas / 5 branches	44,00
04002	27,5 x 11	25	3-flammig / 3-lids / 3 ramas / 3 branches	33,00
	∅ cm	↑ cm		€
04003	11	22	1-flammig / 1 lid / 1 rama / 1 branche	21,00
04004	11	10	1-flammig / 1 lid / 1 rama / 1 branche	14,00



Kerzenleuchter „XXL“

candle holder
candelabro
chandelier



5-flammig, Zinkdruckguss, vernickelt, schwere Ausführung, einfache Montage

5 branches, zinc alloy nickel-plated, heavy model, easy to assemble

5 ramas, fundición de aleación de zinc niquelada, alta calidad y fácil montaje

5 branches, fonte d'alliage de zinc nickelée, haute qualité, facile à monter

	cm	↑ cm		€
04000	46 x 46	56	5-flammig / 5-lids / 5 ramas / 5 branches	104,00
04012	46 x 46	78	5-flammig / 5-lids / 5 ramas / 5 branches	176,00
04013	46 x 46	98	5-flammig / 5-lids / 5 ramas / 5 branches	229,00



Kerzenleuchter „XL“

candle holder
candelabro
grand chandelier



extra hoch und schwer, möbelschonende Unterseite
extra high and heavy, with non-scratching undersurface
pesado y de alta calidad, con base antirralladuras
lourd et de haute qualité, avec base revêtue antirayures

	cm	↑ cm		€
04005	35 x 13	39	3-flammig / 3-lids / 3 ramas / 3 branches	51,00



Kerzenleuchter „XL“

candle holder
candelabro
grand chandelier



extra hoch und schwer, möbelschonende Unterseite
extra high and heavy, with non-scratching undersurface
pesado y de alta calidad, con base antirralladuras
lourd et de haute qualité, avec base revêtue antirayures

	cm	↑ cm		€
04006	35 x 35	39	5-flammig / 5-lids / 5 ramas / 5 branches	64,00



Kerzenleuchter „CLASSIC“, 2er Set

candle holder, 2 pcs. set
candelabros, set de 2 piezas
set de 2 chandeliers



möbelschonende Unterseite
with non-scratching undersurface
con base antirralladuras
avec base revêtue antirayures

	Ø cm	↑ cm	pcs.	€
04035	10	20,5	2	22,00



Kerzenleuchter „CLASSIC“

candle holder
candelabro
chandelier



möbelschonende Unterseite
with non-scratching undersurface
con base antirralladuras
avec base revêtue antirayures

	cm	↑ cm		€
04036	22 x 10	22,5	3-flammig / 3-lids / 3 ramas / 3 branches	22,00



Kerzenleuchter „CLASSIC“

candle holder
candelabros
chandelier



möbelschonende Unterseite
with non-scratching undersurface
con base antirralladuras
avec base revêtue antirayures

	cm	↑ cm		€
04037	22 x 22	24	5-flammig / 5-lids / 5 ramas / 5 branches	27,50



Kerzenleuchter „ELEMENT“

candle holder
candelabro
chandelier



Beton, mit möbelschonender Unterseite

concrete, furniture-friendly underside
hormigón, con base anti rayaduras
béton, avec revêtement antirayures

	Ø cm	↑ cm	€
04027	10	14,5	12,00



Kerzenleuchter

candle holder
candelabro
chandelier



Metall hartverchromt, 1-flammig, standsichere Ausführung

hard chrome plated metal, 1 lid, heavy stable quality
metal duro cromado, 1 brazo, construcción estable
metal chromé dur, 1 flamme, stable

	Ø cm	↑ cm	€
04030	9,5	10	14,00
04031	9,5	16	16,00



Kerzenleuchter, 2er Set

candle holder, 2 pcs. set
candelabros, set de 2 piezas
set de 2 chandeliers



möbelschonende Unterseite

with non-scratching undersurface
con base antirralladuras
avec base revêtue antirayures

	Ø cm	↑ cm	pcs.	€
04008	6	7	2	9,90



Kerzenleuchter

candle holder
candelabro
chandelier



extra schwerer Fuß, verchromt, möbelschonende Unterseite

heavy foot, chrome plated, with non-scratching undersurface
pie pesado, asa cromado, con base antirralladuras
pied lourd, chromé, avec base revêtue antirayures

	Ø cm	↑ cm	Farbe / Colour	€
04020	10	11	—	12,00
04021	10	16	—	14,00
04022	10	22	—	16,00



Windlichter, 2er Set

wind lights, 2 pcs. set
set de 2 portavelas antiviento
set de 2 porte-bougies anti-vent



matt poliert, Gläser satiniert, möbelschonende Unterseite
satin polished finish, glasses satin, with non-scratching undersurface
pulido acabado efecto satinado, cristales satinados, con base antirralladuras
inox mat satiné et verre mat, avec base revêtue antirayures

	Ø cm	↑ cm	pcs.	€
03020	5	15	2	15,40

Ersatzglas / spare glass / cristal de recambio / verre de rechange

	€
03025	1,40



Windlichter „ELEMENT“, 2er Set

wind lights, 2 pcs. set
set de 2 portavelas antiviento
set de 2 porte-bougies anti-vent



Beton, Gläser klar, mit möbelschonender Unterseite
concrete, glass clear, with non-scratching undersurface
hormigón, vidrio transparente, con base antirralladuras
bèton, verre transparente, avec base revêtue antirayures

	Ø cm	↑ cm	pcs.	€
03038	6	8	2	12,00

Ersatzglas / spare glass / vidrio de recambio solo / verre de rechange transparent, seul

	Ø cm	↑ cm	€
03098	6	5	2,80



Windlicht „ELEMENT“

wind light
porta vela
porte-bougie



Beton, Glas klar, mit möbelschonender Unterseite
concrete, glass clear, with non-scratching undersurface
hormigón, vidrio transparente, con base antirralladuras
bèton, verre transparente, avec base revêtue antirayures

	Ø cm	↑ cm	€
03039	7,5	13	9,00

Ersatzglas / spare glass / vidrio de recambio solo / verre de rechange transparent, seul

	Ø cm	↑ cm	€
03099	7,5	9	3,50



Windlicht / Tischleuchte

wind light
porta velas
porte-bougie de table, anti-vent



möbelschonende Unterseite
with non-scratching undersurface
con base antirralladuras
avec base revêtue antirayures

	Ø cm	↑ cm	€
03013	11	22	21,00

Ersatzglas / spare glass / vidrio de recambio solo / verre de rechange transparent, seul

	€
03015	7,20



Vase mit Glaseinsatz „ELEMENT“

flower vase with glass insert
 florero con tubo de cristal
 vase soliflor avec verre



Beton, Glas klar, mit möbelschonender Unterseite, inkl. 2 Ersatzgläsern
 concrete, clear glass, furniture-friendly underside, incl. 2 spare glasses
 hormigón, cristal incoloro, con base anti rayaduras, incl. 2 tubos de repuesto
 béton, verre transparente avec revêtement antirayures y compris 2 verres de rechange

	cm	↑ cm	ml	€
04010	10 x 4,5	12,5	25	6,40

Ersatzglas / spare glass / tubo de recambio / verre de rechange

	Ø cm	↑ cm	ml	€
04011	2,5	11	25	1,20



Vase
 flower vase
 florero
 vase soliflor



Edelstahl-Look, Zinkdruckguss, vernickelt, lackiert, anlaufgeschützt, schwere Ausführung
 stainless steel look, heavy zink alloy, nickel plated, laquered
 aspecto acero, acabado satinado, alta calidad
 aspect inox, fini mat satiné, bonne qualité

	Ø cm	↑ cm	kg	€
04017	6,5	18	0,36	15,00



Vase
 flower vase
 florero
 vase soliflor



Edelstahl-Look, Zinkdruckguss, vernickelt, lackiert, anlaufgeschützt, schwere Ausführung
 stainless steel look, heavy zink alloy, nickel plated, laquered
 aspecto acero, acabado satinado, alta calidad
 aspect inox, fini mat satiné, bonne qualité

	Ø cm	↑ cm	kg	€
04015	4	16,5	0,17	13,00
04016	4,5	20	0,20	14,50

Tischsets



Die umgelegten und angenähten Kanten machen diese Tischsets besonders robust. Geliefert in einer 6er Einheit.

The folded and sewn edges make these table sets particularly robust. Delivered in a packing unit of 6 pieces.

Los bordes doblados y cosidos des los mantelitos los hacen especialmente resistentes. Se entregan en una unidad de embalaje de 6 piezas.

Les bords repliés et cousus rendent ces sets de table en particulièrement robustes. Livré dans un emballage de 6 pièces.



Warenträger - Tischsets

display for table sets
expositor para mantelinas de mesa
présentoir pour sets de table

12 Einschubfächer, komplett auf Rollen, 2 Feststellrollen, Lieferung demontiert

12 shelves, on rolls, 2 rolls to fix, delivery unassembled
12 niveles, 4 ruedas, desmontado (montaje fácil)
12 niveaux, 4 roues, livré démonté

	cm	↑ cm
00401	39,5 x 45	165



60037 - gold

Tischset Feinband

placemat fine band
mantelinas
sets de tables



	cm		VE / unit	€ / pc.
60037	45 x 33	gold / gold	6	2,90
60038	45 x 33	beige braun / beige brown	6	2,90
60039	45 x 33	rot braun / red brown	6	2,90
60040	45 x 33	blau / blue	6	2,90



60037 - gold



60038 - beige brown



60039 - red brown



60040 - blue



60502 - grey, beige

Tischset Feinband „TAO“

placemat fine band
mantelín cinta fina
set de table, tressage fin



	cm		VE / unit	€ / pc.
60502	45 x 33	grau, beige / grey, beige	6	3,80
60503	45 x 33	beige / beige	6	3,80
60505	45 x 33	braun / brown	6	3,80



60502 - grey, beige



60503 - beige



60505 - brown



Tischset „KUNSTLEDER“

placemat
mantelín
set de table



Kunstleder
imitation leather
imitación de cuero
similicuir

	cm		VE / unit	€ / pc.
60044	45 x 32,5	grau / grey	6	9,90
60045	45 x 32,5	braun / brown	6	9,90
60046	45 x 32,5	schwarz / black	6	9,90

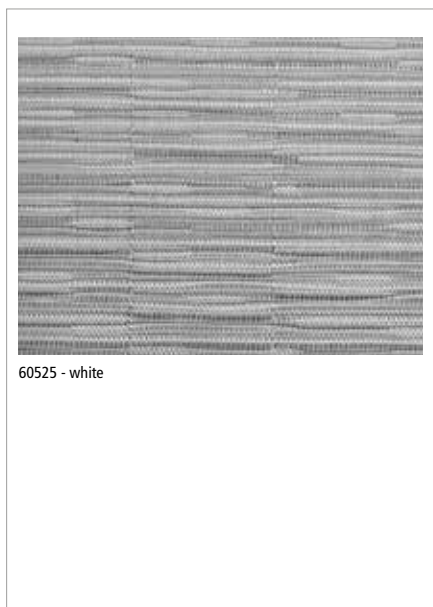
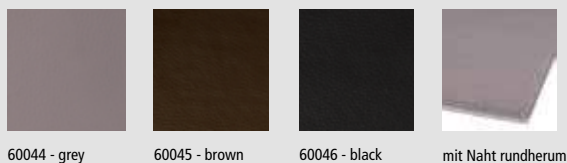

Tischset Schmalband

placemat smallband
mantelín cinta estrecha
set de table tressage étroit



	cm		VE / unit	€ / pc.
60525	45 x 33	weiß / white /	6	2,90
60526	45 x 33	gold / gold /	6	2,90
60527	45 x 33	silber / silver /	6	2,90
60528	45 x 33	grün / green /	6	2,90

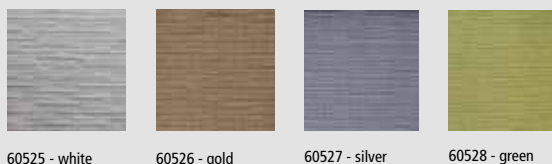

Tischset „CROCO“

placemat
mantelín
set de table



rutschhemmende Unterseite
slip resistant underside
antideslizante por debajo
dessous antiglisse

	cm		VE / unit	€ / pc.
60535	45 x 30	gold / gold	6	5,00
60536	45 x 30	kupfer / copper	6	5,00
60537	45 x 30	braun / brown	6	5,00

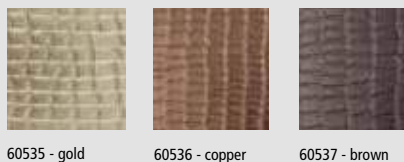

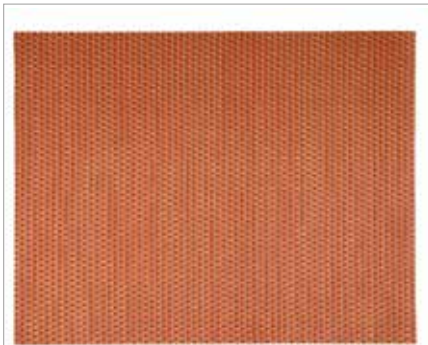

60018 - candyred

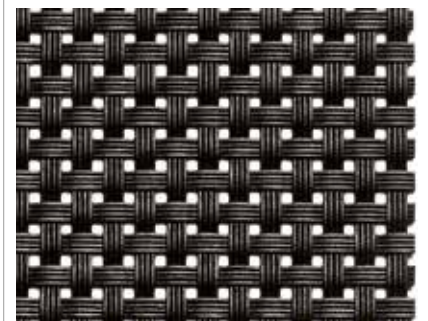

60012 - black



60014 - beige



60041 - light blue, white

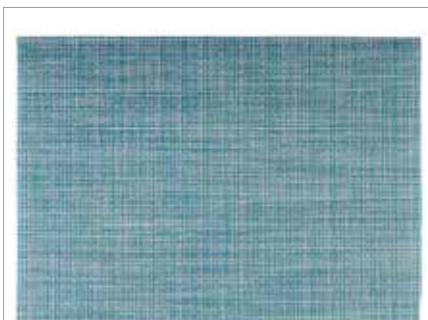

60042 - turquoise, green, white

Tischset Schmalband
 placemat smallband
 mantelín cinta estrecha
 set de table tressage étroit



	cm		VE / unit	€ / pc.
60002	45 x 33	hellblau / light blue	6	2,90
60018	45 x 33	candyrot / candyred	6	2,90
60012	45 x 33	schwarz / black	6	2,90
60014	45 x 33	beige / beige	6	2,90
60015	45 x 33	silbergrau / silvergrey	6	2,90
60016	45 x 33	grün / green	6	2,90
60019	45 x 33	beige braun / beige brown	6	2,90
60522	45 x 33	hellorange / light orange	6	2,90
60520	45 x 33	schwarz weiß / black white	6	2,90
60521	45 x 33	apfelgrün / apple green	6	2,90
60523	45 x 33	violett / purple	6	2,90
60524	45 x 33	platin / platinum	6	2,90
60041	45 x 33	hellblau, weiß / light blue, white	6	2,90

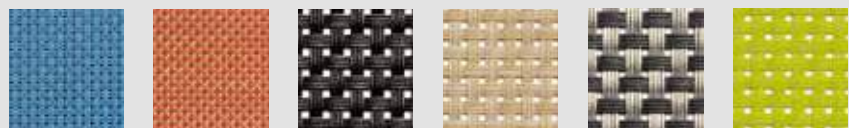

60002 - light blue 60018 - candyred 60012 - black 60014 - beige 60015 - silvergrey 60016 - green

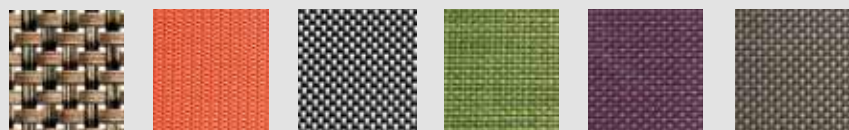

60019 - beige brown 60522 - light orange 60520 - black white 60521 - apple green 60523 - purple 60524 - platinum

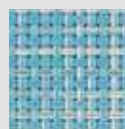

60041 - light blue, white

Tischset Feinband
 placemat fine band
 mantelín
 set de table



	cm		VE / unit	€ / pc.
60042	45 x 33	türkis, grün, weiß / turquoise, green, white	6	2,90
60509	45 x 33	Mosaik schwarz, grau / black, grey	6	2,90
60512	45 x 33	schwarz, grau / black, grey	6	2,90
60542	45 x 33	rot / red	6	2,90



60042 - turquoise, green, white 60509 - black, grey 60512 - black, grey 60542 - red

Tableware . Table Presentation

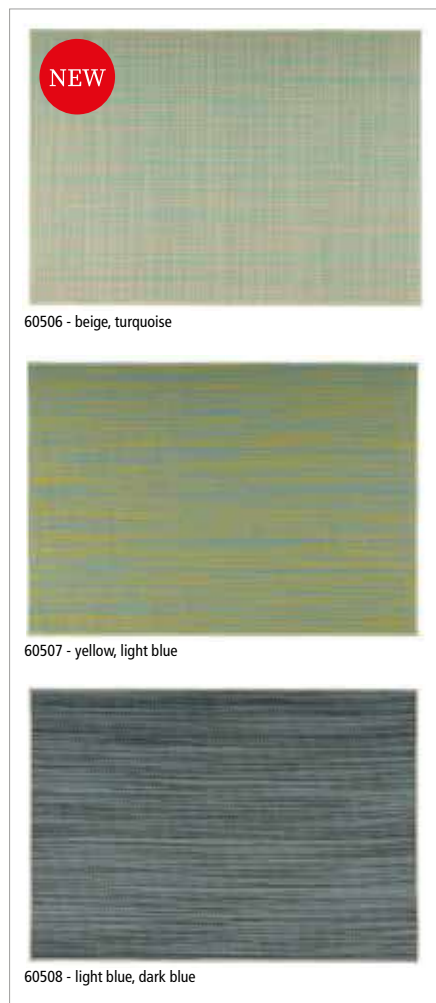

Tischset Feinband „TAO“

placemat fine band
mantelin cinta fina
set de tables



	cm		VE / unit	€ / pc.
60506	45 x 33	beige, türkis / beige, turquoise	6	4,00
60507	45 x 33	gelb, hellblau / yellow, light blue	6	4,00
60508	45 x 33	hellblau, dunkelblau / light blue, dark blue	6	4,00

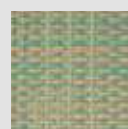

60506 - beige, turquoise

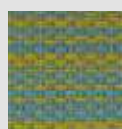

60507 - yellow, light blue

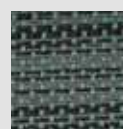

60508 - light blue, dark blue



Tischset Feinband

placemat fine band
mantelin cinta fina
set de tables



	cm		VE / unit	€ / pc.
60510	45 x 33	LINES orange, rot / LINES orange red	6	2,90
60511	45 x 33	LINES orange, gelb / LINES orange yellow	6	2,90
60531	45 x 33	LINES schwarz / LINES black	6	2,90
60532	45 x 33	LINES pastell / LINES pastell	6	2,90
60533	45 x 33	LINES bordeaux / LINES bordeaux	6	2,90
60534	45 x 33	LINES rot / LINES red	6	2,90
60530	45 x 33	STRIPES grau / STRIPES grey	6	2,90
60540	45 x 33	FRAMES grau / FRAMES grey	6	2,90
60541	45 x 33	FRAMES schwarz / FRAMES black	6	2,90

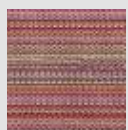

60510 - LINES orange red

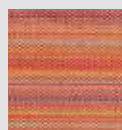

60511 - LINES orange, yellow

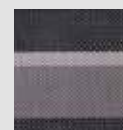

60531 - LINES black



60532 - LINES pastell



60533 - LINES bordeaux

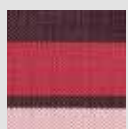

60534 - LINES red

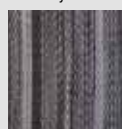

60530 - LINES grey



60540 - FRAMES grey



60541 - FRAMES black

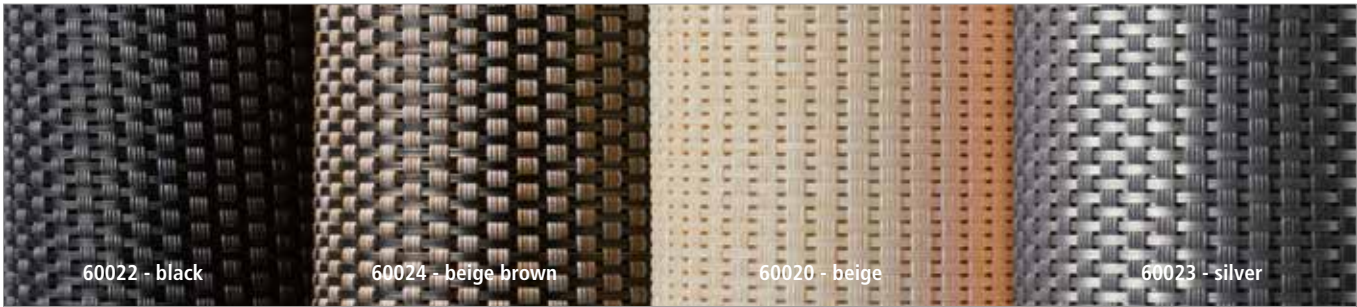

60022 - black

60024 - beige brown

60020 - beige

60023 - silver

Schmalband Tischläufer

table runner fine fabric
camino de mesa
chemin de table

pflegeleichtes Kunststoffgeflecht

easy to clean
fácil de limpiar
nettoyage aisé



	cm		€
60022	45 x 150	schwarz / black	11,90
60024	45 x 150	beige, braun / beige, brown	11,90
60020	45 x 150	beige / beige	11,90
60023	45 x 150	silbergrau / silver grey	11,90



Tableware
Table Presentation



Servietten- und Bestecktaschen, 6er Set

cutlery bag, 6 pcs.
bolsa cubiertos, 6 pz.
pochette couverts, 6 pc.



	cm		pcs.	€ / Set
60551	24 x 9	silbergrau / silvergrey	6	3,90
60550	24 x 9	beige / beige	6	3,90
60552	24 x 9	beige braun / beige brown	6	3,90
60553	24 x 9	apfelgrün / apple green	6	3,90
60554	24 x 9	platin / platinum	6	3,90

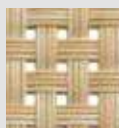

60550 - beige

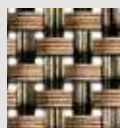

60552 - beige/braun



60553 - apfelgrün



60554 - platin





Körbe

baskets
cestas
corbeilles

SUPERSTRONG



GN 1/1 Korb „SUPERSTRONG“

GN 1/1 basket
GN 1/1 cesta
GN 1/1 corbeille



	cm	↑ cm	GN	Farbe / Colour	€
50640	53,0 x 32,5	6,5	1/1		24,00
50641	53,0 x 32,5	10,0	1/1		28,00
50642	53,0 x 32,5	15,0	1/1		32,00
50643	53,0 x 32,5	6,5	1/1		24,00
50644	53,0 x 32,5	10,0	1/1		28,00
50645	53,0 x 32,5	15,0	1/1		32,00

GN Kuppelhaube / GN cover / GN cúpula / GN cloche bombée

	cm	↑ cm	GN	€
11027	54 x 33	20	1/1	49,00

GN Abdeckhaube / GN cover / GN cubierta / GN cloche

	cm	↑ cm	GN	€
11042	53,0 x 32,5	9,5	1/1	27,00

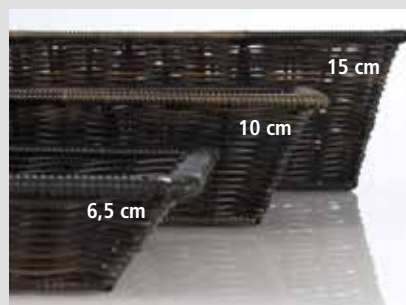

PROFI LINE



Korb "PROFI LINE"
basket baker size
cesta tamaño panaderia
corbeille dimensions „boul-pâte“



	cm	↑ cm	Farbe / Colour	€
50714	30 x 20	5		14,20
50900	40 x 20	5		16,50
50901	40 x 20	5		16,50
50902	40 x 20	5		16,50
50903	40 x 20	5		16,50



Korb "PROFI LINE"
basket baker size
cesta tamaño panaderia
corbeille dimensions „boul-pâte“



	cm	↑ cm	Farbe / Colour	€
50905	40 x 30	5		19,00
50906	40 x 30	5		19,00
50907	40 x 30	5		19,00
50908	40 x 30	5		19,00
50710	40 x 30	10		19,80
50711	40 x 30	10		19,80
50713	40 x 30	10		19,80
50712	40 x 30	10		19,80



Korb "PROFI LINE"
basket baker size
cesta tamaño panaderia
corbeille dimensions „boul-pâte“



	cm	↑ cm	Farbe / Colour	€
50910	60 x 20	5		20,60
50911	60 x 20	5		20,60
50912	60 x 20	5		20,60
50913	60 x 20	5		20,60

Körbe

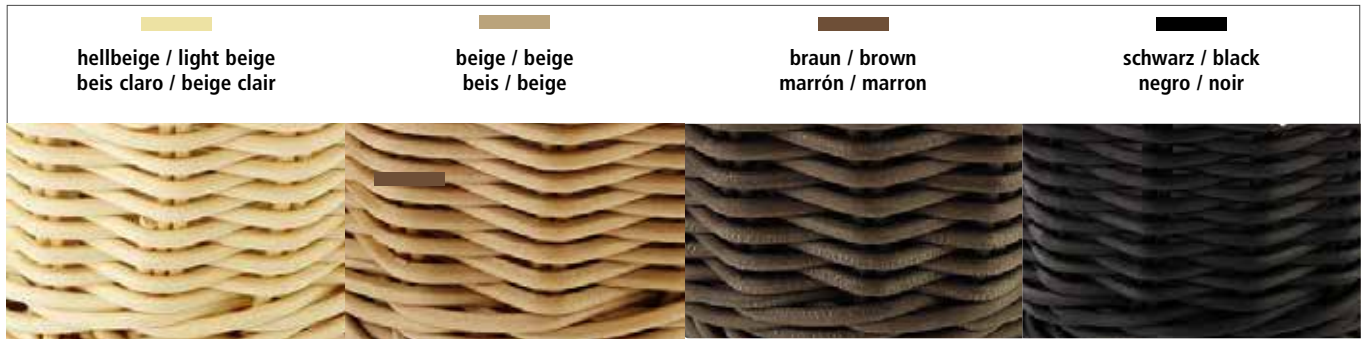

Korb "PROFI LINE"

basket baker size
cesta tamaño panaderia
corbeille dimensions „boul-pâte“



	cm	↑ cm	Farbe / Colour	€
50915	60 x 40	5		30,00
50916 <small>NEW</small>	60 x 40	5		30,00
50917 <small>NEW</small>	60 x 40	5		30,00
50918 <small>NEW</small>	60 x 40	5		30,00



GN 1/1 Korb „PROFI LINE“

GN 1/1 basket
GN 1/1 cesta
GN 1/1 corbeille



	cm	↑ cm	Farbe / Colour	€
50720	53 x 32,5	10		24,00
50721	53 x 32,5	10		24,00
50723	53 x 32,5	10		24,00
50722	53 x 32,5	10		24,00



Korb, rechteckig „PROFI LINE“

basket, rectangular
cesta, rectangular
corbeille, rectangulaire



	cm	↑ cm	Farbe / Colour	€
50700	26,5 x 19,0	7		9,20
50701	26,5 x 19,0	7		9,20
50703	26,5 x 19,0	7		9,20
50702	26,5 x 19,0	7		9,20
	cm	↑ cm	Farbe / Colour	€
50705	31,0 x 21,0	9		10,40
50706	31,0 x 21,0	9		10,40
50708	31,0 x 21,0	9		10,40
50707	31,0 x 21,0	9		10,40



Brötchenschütte „PROFI LINE“

roll / bun basket
cesta para bollos
corbeille à petits pains



	cm	↑ cm	€
50510	60 x 40	60	122,00



Stangenbrotkorb „PROFI LINE“

baguette basket
cesta de baguette
corbeille à baguettes



	Ø cm	↑ cm	Farbe / Colour	€
50500	28 / 30	38		41,00
50501	28 / 30	38		41,00

50500

50501



Auslage Tablett flach „PROFI LINE“

display tray flat, baker size
bandeja de presentación, tamaño panaderia
plateau de présentation, dimensions „boul-pâte“



	cm	↑ cm	€
40296	40 x 30	1	13,50
40297	60 x 40	1	24,00

40296

Körbe



Korb, rund „PROFI LINE“

basket, round
cesta redonda
corbeille ronde



	Ø cm	↑ cm	€
50210	37	9	15,40
50215	42	12	21,00



Korb, rund „PROFI LINE“

basket, round
cesta redonda
corbeille ronde



	Ø cm	↑ cm	€
50205	31 / 37	12 / 6	19,80



Korbschütte, rund „PROFI LINE“

basket, round
cesta redonda
corbeille ronde



	Ø cm	↑ cm	€
50100	36,5	12,0	26,50
50105	42,0	18,5	28,50
50110	46,0	18,5	36,40



Systemkorb, gestäbt „PROFI LINE“

basket
cesta
corbeille



	cm	↑ cm	€
50300	30 x 40	27 / 16	59,00
50305	45 x 40	27 / 16	64,00
50310	60 x 40	27 / 16	69,00



Systemkorb „PROFI LINE“

basket
cesta
corbeille



	cm	↑ cm	€
50400	40 x 50	25 / 14	49,90



Trenner „PROFI LINE“

divider
divisor
paroi de séparation



	↑ cm	→ cm	€
50315	26 / 15	38	10,00



Baguette Korb, oval „PROFI LINE“

baguette basket, oval
cesta de baguette, oval
corbeille à baguettes, ovale



	cm	↑ cm	Farbe / Colour	€
50805	28 x 16	8		8,70
50806	28 x 16	8		8,70
50808	28 x 16	8		8,70
50807	28 x 16	8		8,70

	cm	↑ cm	Farbe / Colour	€
50820	40 x 16	8		11,60
50821	40 x 16	8		11,60
50823	40 x 16	8		11,60
50822	40 x 16	8		11,60



Korb, oval „PROFI LINE“

basket, oval
cesta oval
corbeille ovale



	cm	↑ cm	Farbe / Colour	€
50800	25 x 19	6,5		7,80
50801	25 x 19	6,5		7,80
50803	25 x 19	6,5		7,80
50802	25 x 19	6,5		7,80

	cm	↑ cm	Farbe / Colour	€
50815	32 x 23	7,0		10,00
50816	32 x 23	7,0		10,00
50818	32 x 23	7,0		10,00
50817	32 x 23	7,0		10,00



Korb, rund „PROFI LINE“

basket, round
cesta redonda
corbeille ronde



	Ø cm	↑ cm	Farbe / Colour	€
50600	16	8		6,60
50601	16	8		6,60
50603	16	8		6,60
50602	16	8		6,60

	Ø cm	↑ cm	Farbe / Colour	€
50605	20	8		8,70
50606	20	8		8,70
50608	20	8		8,70
50607	20	8		8,70

	Ø cm	↑ cm	Farbe / Colour	€
50610	29	7		10,90
50611	29	7		10,90
50613	29	7		10,90
50612	29	7		10,90

Körbe



Korb, oval „PROFI LINE“

basket, oval
cesta, oval
corbeille, ovale



	cm	↑ cm	Farbe / Colour	€
50624	19 x 12	6		4,20
50625	19 x 12	6		4,20
50626	19 x 12	6		4,20
50627	19 x 12	6		4,20



Korb, rechteckig „PROFI LINE“

basket, rectangular
cesta rectangular
corbeille rectangulaire



	cm	↑ cm	Farbe / Colour	€
50632	17 x 11	9		4,00
50633	17 x 11	9		4,00
50635	17 x 11	9		4,00
50634	17 x 11	9		4,00

	cm	↑ cm	Farbe / Colour	€
50628	19 x 13	6		4,20
50629	19 x 13	6		4,20
50630	19 x 13	6		4,20
50631	19 x 13	6		4,20



Korb, rund „PROFI LINE“

basket, round
cesta, redonda
corbeille, ronde



	Ø cm	↑ cm	Farbe / Colour	€
50620	13	10		4,20
50621	13	10		4,20
50622	13	10		4,20
50623	13	10		4,20

GN LINE



2 Höhen - 6,5 und 10 cm
2 heights - 6,5 and 10 cm



40293
GN 1/1 - 10 cm



40292
GN 1/2 - 10 cm

40225
GN 1/4 - 6,5 cm

Korb „GN LINE“

GN basket
GN cesta
GN corbeille



stabile Ausführung mit Edelstahldraht im Rand zur Stabilisierung
very solid with stainless steel wire frame to stabilize the basket
muy resistente con refuerzo de alambre inox
très résistante avec son fil de renfort inox

	cm	↑ cm	GN	Farbe / Colour	€
40291	53,0 x 32,5	6,5	1/1	■ ■	18,50
40290	32,5 x 26,5	6,5	1/2	■ ■	11,50
40223	32,5 x 17,5	6,5	1/3	■ ■	9,20
40225	26,5 x 16,2	6,5	1/4	■ ■	7,00
40227	17,6 x 16,2	6,5	1/6	■ ■	4,70
40229	32,5 x 35,4	6,5	2/3	■ ■	13,80

	cm	↑ cm	GN	Farbe / Colour	€
40293	53,0 x 32,5	10,0	1/1	■ ■	23,00
40292	32,5 x 26,5	10,0	1/2	■ ■	13,80
40243	32,5 x 17,5	10,0	1/3	■ ■	11,00
40245	26,5 x 16,2	10,0	1/4	■ ■	8,20
40247	17,6 x 16,2	10,0	1/6	■ ■	7,00
40249	32,5 x 35,4	10,0	2/3	■ ■	17,20



GN 1/1

GN 1/1 Besteckbehälter

GN 1/1 dispenser GN
GN 1/1 dispensador de cubiertos
GN 1/1 bac à couverts



in Handarbeit geflochten, 4 Mulden, Kunststoff-Geflecht, Drahtgestell, braun-schwarz
wickerwork, 4 compartments, with reinforced chromed wire structure, brown-black
cesta trensada a mano, 4 compartimentos, de plástico, con bastidor cromado reforzado, marrón oscuro
corbeille tressée à main, 4 compartiments, en plastique, cadre acier chromé renforcé, couleur marron foncé

	cm	↑ cm	GN	Farbe / Colour	€
11966	53 x 32,5	9	1/1	■ ■	33,00

GN LINE

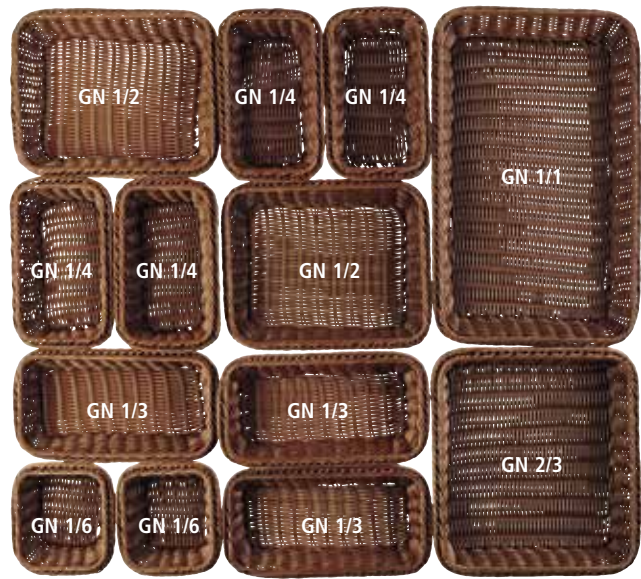
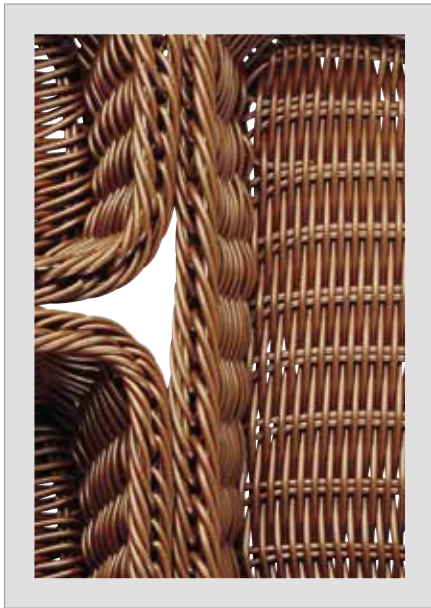

Korb „GN LINE“

GN basket
GN cesta
GN corbeille



stabile Ausführung mit Edelstahldraht im Rand zur Stabilisierung
very solid with stainless steel wire frame to stabilize the basket
muy resistente con refuerzo de alambre inox
très résistante avec son fil de renfort inox

	cm	↑ cm	GN	Farbe / Colour	€
40220	53 x 32,5	6,5	1/1		17,20
40222	32,5 x 26,5	6,5	1/2		10,00
40224	32,5 x 17,6	6,5	1/3		8,40
40226	26,5 x 16,2	6,5	1/4		6,50
40228	17,6 x 16,2	6,5	1/6		4,40
40230	32,5 x 35,4	6,5	2/3		13,20

	cm	↑ cm	GN	Farbe / Colour	€
40240	53 x 32,5	10	1/1		21,90
40242	32,5 x 26,5	10	1/2		13,40
40244	32,5 x 17,6	10	1/3		10,00
40246	26,5 x 16,2	10	1/4		7,20
40248	17,6 x 16,2	10	1/6		5,90
40250	32,5 x 35,4	10	2/3		16,00

	cm	↑ cm	GN	Farbe / Colour	€
40260	53 x 32,5	6,5	1/1		17,20
40262	32,5 x 26,5	6,5	1/2		10,40
40263	32,5 x 17,6	6,5	1/3		8,40
40264	26,5 x 16,2	6,5	1/4		6,50
40266	17,6 x 16,2	6,5	1/6		4,40
40268	32,5 x 35,4	6,5	2/3		13,20

	cm	↑ cm	GN	Farbe / Colour	€
40270	53 x 32,5	10	1/1		21,90
40272	32,5 x 26,5	10	1/2		13,40
40274	32,5 x 17,6	10	1/3		10,00
40276	26,5 x 16,2	10	1/4		7,20
40278	17,6 x 16,2	10	1/6		5,90
40280	32,5 x 35,4	10	2/3		16,00

ECONOMIC



Tisch- und Buffetkorb, rund „ECONOMIC“

buffet basket, round
cesta de buffet, redonda
corbeille de buffet, ronde



	Ø cm	↑ cm	Farbe / Colour	€
40132	19,0	9,5		3,60
40135	25,5	8,5		4,90
40144	39,0	10,0		13,80
40191	19,0	9,5		3,60
40192	25,5	8,5		4,90



Tisch- und Buffetkorb, oval „ECONOMIC“

buffet basket, oval
cesta de buffet, oval
corbeille de buffet, ovale



	cm	↑ cm	Farbe / Colour	€
40137	23,0 x 17,0	8,0		4,00
40139	28,5 x 17,0	8,5		5,20
40193	23,0 x 17,0	8,0		4,00
40194	28,5 x 17,0	8,5		5,20



Tisch- und Buffetkorb, eckig „ECONOMIC“

buffet basket, rectangular
cesta de buffet, rectangular
corbeille de buffet, rectangulaire



	cm	↑ cm	Farbe / Colour	€
40140	23,0 x 17,0	8		4,00
40159	31,5 x 22,0	8,5		6,00
40195	23,0 x 17,0	8		4,00
40196	31,5 x 22,0	8,5		6,00



GN Buffetkorb „ECONOMIC“

GN basket
GN cesta
GN corbeille



	cm	↑ cm	GN	Farbe / Colour	€
40148	53,0 x 32,5	8	1/1		24,00



GN Buffetkorb „ECONOMIC“

GN basket
GN cesta
GN corbeille



	cm	↑ cm	GN	Farbe / Colour	€
40152	32,5 x 26,5	8	1/2		8,90

Körbe



Buffetkorb „ECONOMIC“

buffet basket
cesta de buffet
corbeille de buffet



stabile Ausführung mit Edelstahldraht im Rand zur Stabilisierung

very solid with stainless steel wire frame to stabilize the basket

muy resistente con refuerzo de alambre inox

très résistante avec son fil de renfort inox

	cm	↑ cm	GN	€
40129	53 x 32,5	15,5	1/1	26,00

GN Kuppelhaube / GN cover / GN cúpula / GN cloche bombée

	cm	↑ cm	€
11027	54 x 33	20	49,00



Buffetkorb „ECONOMIC“

buffet basket
cesta de buffet
corbeille de buffet



stabile Ausführung mit Edelstahldraht im Rand zur Stabilisierung

very solid with stainless steel wire frame to stabilize the basket

muy resistente con refuerzo de alambre inox

très résistante avec son fil de renfort inox

	cm	↑ cm	€
40153	45 x 42	17 / 24	25,00



Buffetkorb, rund „ECONOMIC“

buffet basket, round
cesta de buffet, redonda
corbeille de buffet ronde



stabile Ausführung mit Edelstahldraht im Rand zur Stabilisierung

very solid with stainless steel wire frame to stabilize the basket

muy resistente con refuerzo de alambre inox

très résistante avec son fil de renfort inox

	Ø cm	↑ cm	Farbe / Colour	€
40149	40	12,5		18,40
40295	40	12,5		19,80

Rolltophaube / rolltop cover / campana abatible / cloche basculante

	Ø cm	↑ cm		€
18388	38	20	mit verchromtem Kugelgriff with chrome plated handle con pomo cromado / avec bouton chromé	19,40
18387	38	20	mit vergoldetem Kugelgriff / gold plated handle pomo dorado / bouton doré	19,40
18389	38	20	mit verchromtem Designergriff / with chrome plated designer handle	21,00



Buffetkorb „ECONOMIC“

buffet basket
cesta de buffet
corbeille buffet



in Handarbeit geflochten, stabile Ausführung, Edelstahl Fixierungsrahmen, zur Rutschsicherung, ohne Haube

wickerwork, stainless steel fix the cover, without cover

cesta trensada a mano, con marco cromado patentado para fijar y encajar la campana (se entrega sin la campana)

corbeille tressée main, cadre fil acier inoxydable pour fixer la cloche (livré sans la cloche)

	cm	↑ cm	Farbe / Colour	€
40150	56,5 x 36	10		30,00
40294	56,5 x 36,0	10,0		28,70

GN 1/1 Rolltop-Haube / GN 1/1 rolltop cover / GN 1/1 campana abatible
GN 1/1 cloche basculante

	cm	↑ cm	GN		€
11008	53,0 x 32,5	19	1/1	vergoldeter Griff / gold plated handle pomo dorado / bouton doré	59,90
11010	53,0 x 32,5	19	1/1	verchromter Griff / chrome plated handle pomo cromado / bouton chromé	59,90
11018	53,0 x 32,5	17	1/1	mit verchromtem Designergriff with chrome plated designer handle	62,00



GN Kuppelhaube

GN cover
GN cúpula
GN cloche bombée



glasklarer Kunststoff, Griff verchromt

clear, chrome knob

transparente, asa cromada

transparente, anse chromée

	cm	↑ cm	GN		€
11021	33 x 28	17	1/2	geschlossen / totally closed cerrada / toalement fermée	22,00
11022	33 x 28	17	1/2	mit Front-Ausschnitt / one long side cut out gran apertura frontal grande ouverture frontale	24,00
11026	54 x 33	20	1/1	geschlossen / totally closed cerrada / toalement fermée	47,00
11027	54 x 33	20	1/1	mit Front-Ausschnitt / one long side cut out gran apertura frontal grande ouverture frontale	49,00
11028	54 x 33	20	1/1	mit seitlichem Ausschnitt one small side cut out pequeña apertura lateral petite ouverture latérale	49,00

Körbe



Buffetgestell für Körbe

buffet stand for baskets
expositor para cestas
support pour corbeilles



2-stufig, für 2 rechteckige Körbe, platzsparend zusammenklappbar, Lieferung ohne Körbe

2-tier, for 2 rectangular baskets, can be folded, place saving, delivery without baskets

2 alturas, para 2 cestas rectangulares, totalmente plegable para ahorrar espacio, se entrega sin cestas

2 hauteurs, pour 2 corbeilles rectangulaires, pliable pour son rangement, livré sans corbeilles

	cm	↑ cm	€
33221	46 x 24	18 - 21	39,00

Tisch- und Buffetkorb rechteckig „BASIC“ / buffet basket, square / cesta de buffet, cuadrada / corbeille de buffet, carré

	cm	↑ cm	Farbe / Colour	€
30286	30,0 x 22,0	7		3,30
30288	41,0 x 29,0	7		6,40

Tisch- und Buffetkorb, eckig „ECONOMIC“ / buffet basket rectangular / cesta de buffet, rectangular / corbeille de buffet rectangulaire

	cm	↑ cm	Farbe / Colour	€
40159	31,5 x 22,0	8,5		6,00
40161	50,0 x 25,0	6		14,00

Korb „GN LINE“ / GN basket / GN cesta / GN corbeille

	cm	↑ cm	Farbe / Colour	€
40222	32,5 x 26,5	6,5		10,00
40242	32,5 x 26,5	10		13,40
40262	32,5 x 26,5	6,5		10,40
40272	32,5 x 26,5	10		13,40



Buffetgestell „DOPPELDECKER“ für GN

buffet frame for GN
estructura para buffet para GN
support buffet pour GN



2-teilig, einfach zusammensetzbar, Etagen-Abstand ca. 26 cm, platzsparend, stabile Ausführung

2 pcs., easy to assemble, distance between the tiers approx. 26 cm, space-saving, robust

2 pzas, fácil de montar, distancia entre pisos aprox. 26 cm, robusto

2 pcs, assemblage facile, distance entre niveaux approx. 26 cm, robuste

	cm	↑ cm	fits to GN	€
11555	50 x 34	37,5	1/1	62,00
11553	29 x 27	35	1/2	46,00



40198

Baguettekorb „ECONOMIC“

baguette basket
cesta para baguette
corbeille pour baguettes



stabile Ausführung mit Edelstahldraht im Rand zur Stabilisierung

very solid with stainless steel wire frame to stabilize the basket

muy resistente con refuerzo de alambre inox

très résistante avec son fil de renfort inox

	Ø cm	↑ cm	Farbe / Colour	€
40198	35	25 / 42		40,00
40199	35	25 / 42		40,00



Brot- und Obstkorb „ECONOMIC“

basket for bread or fruits
cesta para pan o fruta
corbeille à pain ou à fruits



	Ø cm	↑ cm	€
40125	23	7	4,50



Brot- und Obstkorb „ECONOMIC“

basket for bread or fruits
cesta para pan o fruta
corbeille à pain ou à fruits



	cm	↑ cm	€
40127	27 x 20	10	4,50



40179

40182

Besteckkorb „ECONOMIC“

cutlery dispenser
dispensador de cubiertos
corbeille à couverts



4 Fächer, 3 kleine Fächer, 1 großes Fach

4 troughs

4 huecos

4 classements

	cm	↑ cm	Farbe / Colour	€
40179	26 x 18	15		11,90
40182	26 x 18	15		11,90

Körbe



Besteckkorb „ECONOMIC“
 cutlery dispenser
 dispensador de cubiertos
 corbeille à couverts



in Handarbeit geflochten
 wickerwork
 trensado a mano
 tressage à main

	Ø cm	↑ cm	Farbe / Colour	€
40130	12	15		3,20
40007	12	15		3,20
40012	12	15		3,20
40013	12	15		3,20



Besteckkorb „ECONOMIC“
 cutlery dispenser
 dispensador de cubiertos
 corbeille à couverts



in Handarbeit geflochten
 wickerwork
 trensado a mano
 tressage à main

	cm	↑ cm	Farbe / Colour	€
40131	27 x 10	4,5		3,20
40009	27 x 10	4,5		3,20
40010	27 x 10	4,5		3,20
40011	27 x 10	4,5		3,20

WICKER LOOK

sehr formstabil, Kunststoff gespritzt



40214
 Ø 20 cm



40216
 23 x 17 cm



40211
 39,5 x 29,5 cm

Brot- und Obstkorb „WICKER LOOK“
 basket for bread or fruits
 cesta para pan o fruta
 corbeille à pain ou à fruits



	Ø cm	↑ cm	Farbe / Colour	€
40214	20	6,5		2,50
40216	23 x 17	6,5		2,80

	cm	↑ cm	Farbe / Colour	€
40211	39,5 x 29,5	10		6,90
40212	39,5 x 29,5	10		6,90
40210	39,5 x 29,5	10		6,90



- in Handarbeit geflochten, einfache und leichte Ausführung
- wickerwork, simple and light version
- ligera, trensada a mano
- tressé à main, version légère



Brot- und Obstkorb oval „BASIC“

basket for bread or fruits
cesta para pan o fruta
corbeille à pain ou à fruits



	cm	↑ cm	€
30279	18 x 12	7	2,30
30280	23 x 15	6	2,40



Brot- und Obstkorb oval „BASIC“

basket for bread or fruits
cesta para pan o fruta
corbeille à pain ou à fruits



	cm	↑ cm	€
30282	21 x 10	6	2,20
30284	36 x 15	7	3,50



Brot- und Obstkorb rund „BASIC“

basket for bread or fruits
cesta para pan o fruta
corbeille à pain ou à fruits



	Ø cm	↑ cm	€
30281	20	7	2,40
30285	25	7	3,50



Tisch- und Buffetkorb rechteckig „BASIC“

buffet basket
cesta de buffet
corbeille de buffet



	cm	↑ cm	€
30286	30,0 x 22,0	7	3,30
30288	41,0 x 29,0	7	6,40
30283	22,0 x 15,0	6	2,70



Brot- und Obstkorb quadratisch „BASIC“

basket for bread or fruits
cesta para pan o fruta
corbeille à pain ou à fruits



	cm	↑ cm	€
30287	24 x 24	6	3,50

PAPERBAGS



Brottasche „PAPERBAG“

bread basket
panera
corbeille



robustes Kraftpapier
robust kraft paper
robusto papel kraft
papier kraft robuste

	Ø cm	↑ cm	Farbe / Colour		€
30440	17	11		Tischkorb / table size	6,80
30450	20	13		Tischkorb / table size	7,80
30442	24	24		Buffetkorb / buffet size	12,00
30443	30	22		Buffetkorb / buffet size	14,00
30441	17	11		Tischkorb / table size	6,80
30451	20	13		Tischkorb / table size	7,80
30445	24	24		Buffetkorb / buffet size	12,00
30446	30	22		Buffetkorb / buffet size	14,00



Brottasche „PAPERBAG“

bread basket
panera
corbeille



robustes Kraftpapier
robust kraft paper
robusto papel kraft
papier kraft robuste

	cm	↑ cm	Farbe / Colour		€
30444	30 x 20	18			11,00
30447	30 x 20	18			11,00



Brottasche
bread basket
panera
corbeille à pain en toile

BAUM-
WOLLE
COTTON

Baumwolle, umgekrempelt kann die Höhe individuell gestaltet werden, maschinenwaschbar bis 30°C, rund oder oval
cotton, adjustable height, mashine-washable 30°C, round or oval
algodón, altura ajustable, lavable a máquina 30°C, redondo u oval
coton, hauteur ajustable, lavable en machine maxi 30°C, rond ou ovale

	Ø cm	↑ cm	Farbe / Colour	€
30340	17	8		6,50
30350	20	9		7,20
30341	17	8		6,50
30351	20	9		7,20
30360	20 x 15	7		6,90
30370	25 x 18	9		7,70
30361	20 x 15	7		6,90
30371	25 x 18	9		7,70



mit
Zugverschluss

Brottasche mit Wärmekissen
bread basket with stones pillow
panera con cojin
corbeille à pain en toile avec coussin chauffant

BAUM-
WOLLE
COTTON



Baumwolle, Keramik-Kugeln
cotton, ceramic stones
algodón, bolas de cerámica
coton, billes de céramiques

	Ø cm	↑ cm	Farbe / Colour	€
30380	20	23,5		19,90
30390	20	23,5		19,90

Wärmekissen / stones pillow / cojín de piedrecillas a calentar / coussin de petites pierres, à chauffer

	Ø cm	↑ cm	Farbe / Colour	€
30385	19	1,5		5,60



Eierkorb „PROFI LINE“
eggs basket
cesta de huevos
panier à oeufs

PP POLYPROP.
EDELSTAHL STAINLESS INOX



mit Edelstahlraht im Rand, für ca. 20 Eier, hält den Inhalt durch das Stoff-Futter lange warm
willow, stable, for around 20 eggs, keeps eggs warm
ratán, calidad fuerte, para unos 20 huevos, mantiene los huevos calientes
rotin, résistant, belle qualité, pour environ 20 oeufs, pour maintenir les oeufs bien chauds

	Ø cm	↑ cm	Farbe / Colour	€
40299	26	17		16,00



Eierkorb
egg basket
cesta de huevos
panier à oeufs

RATTAN NATUR



stabile Vollweide, für ca. 20 Eier, hält den Inhalt durch das Stoff-Futter lange warm
willow, stable, for around 20 eggs, keeps eggs warm
ratán, calidad fuerte, para unos 20 huevos, mantiene los huevos calientes
rotin, résistant, belle qualité, pour environ 20 oeufs, pour maintenir les oeufs bien chauds

	Ø cm	↑ cm	Farbe / Colour	€
30299	26	17		14,00

Körbe



Korb „URBAN“

basket
cesta
corbeille



	Ø cm	↑ cm	Farbe / Colour	€
30410	17	7	■	12,00
30411	20	8,5	■	15,00



Korb „URBAN“

basket
cesta
corbeille



	cm	↑ cm	Farbe / Colour	€
30412	21 x 10	7	■	10,00
30413	30 x 14	12	■	17,00



GN Korb „URBAN“

GN basket
GN cesta
GN corbeille

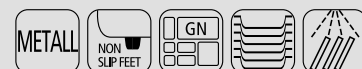

	cm	↑ cm	GN	Farbe / Colour	€
30414	53,0 x 32,5	7,5	1/1	■	29,00
30415	32,5 x 26,5	7,5	1/2	■	22,00
30416	53,0 x 16,2	7,5	2/4	■	22,00

GN Abdeckhaube / GN cover / GN cubierta / GN cloche

	cm	↑ cm	GN	Farbe / Colour	€
11044 <small>NEW</small>	53,0 x 16,2	10,5	2/4		28,00
11042	53,0 x 32,5	9,5	1/1		28,00
11022	33 x 28	17	1/2	ohne Abbildung	24,00
11027	54 x 33	20	1/1	ohne Abbildung	49,00



Brot- und Obstkorb „WIRE“

wire basket
cesta para pan o fruta
corbeille pour pain ou fruits



	Ø cm	↑ cm	Farbe / Colour	€
30205	31	14	metal chrome	14,00



	Ø cm	↑ cm	Farbe / Colour	€
30206	31	14	metal black	14,00



Brot- und Obstkorb

basket for bread or fruits
cesta para pan o fruta
corbeille à pain ou à fruits



hochglanzpoliert
mirror polished finish
acabado pulido brillante
brillant

	Ø cm	↑ cm	€
30200	17,5	7	12,00
30220	20,5	8,5	15,00
30230	25,5	9,5	16,40

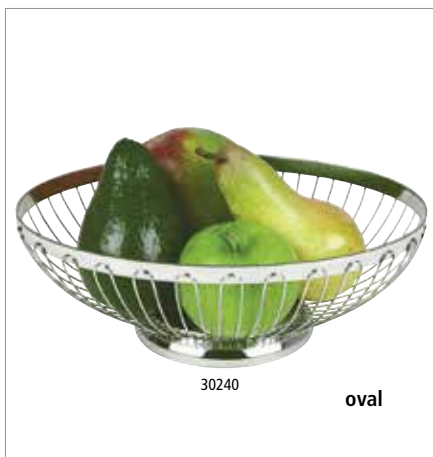

Brot- und Obstkorb

basket for bread or fruits
cesta para pan o fruta
corbeille à pain ou à fruits



hochglanzpoliert
mirror polished finish
acabado pulido brillante
brillant

	cm	↑ cm	€
30210	20 x 15	7	12,00
30240	24 x 19	8,5	15,00
30250	28 x 21	9,5	16,40



Obstkorb

basket for fruits
cesta para fruta
corbeille à fruits



hochglanzpoliert
mirror polished finish
acabado pulido brillante
brillant

	Ø cm	↑ cm	€
30270	21,5	20,5	33,00

Körbe baskets

Körbe



Brot- und Obstkorb „STRIPES“

basket for bread or fruits
cesta para pan o fruta
corbeille à pain ou fruits

außen hochglanzpoliert, innen matt

outside mirror polished finish, inside matt
exterior acabado pulido brillante, interior mate
extérieur brillant, intérieur pâle



	Ø cm	↑ cm	€
30273	17	5	9,90
30274	20	6	13,90



Brot- und Obstkorb

basket for bread or fruits
cesta para pan o fruta
corbeille à pain ou fruits



	Ø cm	↑ cm	€
30310	18	7,5	5,70
30320	23	9	6,30



Brot- und Obstschale

bowl for bread or fruits
bol para pan o frutas
bol à pain ou à fruits

hochglanzpoliert, Hammerschlag Optik

mirror polished finish, hammered look
acabado pulido efecto espejo, aspecto repujado
brillant, aspect martelé



	Ø cm	↑ cm	€
30276	16	5	3,20
30277	20	5,5	5,40



Edelstahl-Schale

bowl
bandeja ovalada inox
corbeille ovale inox

ingerollter Rand

rolled edge
borde redondeado
bord roulé



	cm	↑ cm	€
40110	26,5 x 18,5	4,0	7,40
40115	31,0 x 21,0	4,5	10,50



Etagère

etagère
frutero
corbeille à fruits

ergonomischer Griff, stehend auf schwarzen Antirutsch-Füßen

ergonomic handle, anti-slip-feet
asa ergonómica, pies antideslizantes color negro
anse ergonomique, pieds antidérapants noirs



	cm	↑ cm	€
30325	30 x 30	35,5	11,80



Buffetständer / -korb „ASIA PLUS“

buffet stand / basket
soporte para buffet / cesta
présentoir buffet / corbeille



	Ø cm	↑ cm	Farbe / Colour	€
15507	15	10,5		44,00
15510	15	10,5		44,00



Buffetständer / -korb „ASIA PLUS“

buffet stand / basket
soporte para buffet / cesta
présentoir buffet / corbeille



	Ø cm	↑ cm	Farbe / Colour	€
15508	21	10,5		59,00
15511	21	10,5		59,00



Buffetständer / -korb „ASIA PLUS“

buffet stand / basket
soporte para buffet / cesta
présentoir buffet / corbeille



	Ø cm	↑ cm	Farbe / Colour	€
15509	21	20		79,00
15512	21	20		79,00

Körbe



Korb / Ständer „BASKET“

basket / riser
cesta / soporte
corbeille / support



	Ø cm	↑ cm	Farbe / Colour	€
15321	21 / 15	11		25,00
15325	21 / 15	11		25,00
15323	21 / 15	11		25,00



Korb / Ständer „BASKET“

basket / riser
cesta / soporte
corbeille / support



	Ø cm	↑ cm	Farbe / Colour	€
15320	10,5 / 8	8		14,50
15324	10,5 / 8	8		14,50
15322	10,5 / 8	8		14,50



Korb / Ständer „BASKET“

basket / riser
cesta / soporte
corbeille / support



Chrom poliert
polished chrome
color plata brillante
chrome poli

	Ø cm	↑ cm	Farbe / Colour	€
15331	15	10,5		25,00
15332	21	20		40,00



Korb / Ständer „BASKET“

basket / riser
cesta / soporte
corbeille / support



Gold, gebürstet
brushed gold
dorado cepillado
doré brossé

	Ø cm	↑ cm	Farbe / Colour	€
15334	15	10,5		25,00
15335	21	20		40,00



Korb / Ständer „BASKET“

basket / riser
cesta / soporte
corbeille / support



	Ø cm	↑ cm	Farbe / Colour	€
15326	21 / 15	21	■	25,00



Box „BROTSTATION“

box
caja de pan para buffet
boîte à pain pour le buffet



Buchen-Holz

beech
haya
hêtre

	cm	↑ cm	€
00959	34 x 26	12,5	50,00
00954	34 x 26	20,0	56,00

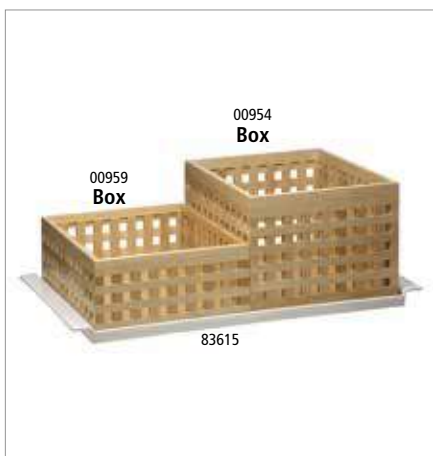

Tablett „BROTSTATION“

tray
bandeja
plateau



Antirutsch-Füßchen

non-slip feet
pies antideslizantes
pieds antidérapants

	cm	↑ cm	€
83615	59,5 x 35,5	3,5	37,00

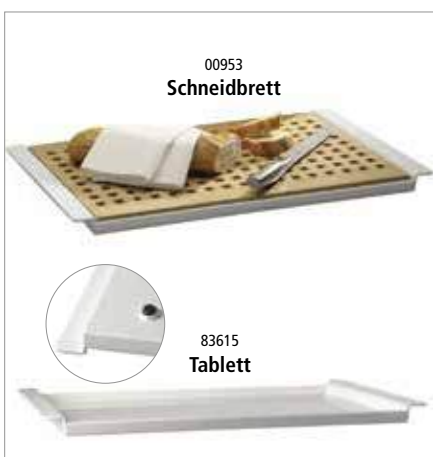

Brot Schneidebrett „BROTSTATION“

cutting board
tabla de corte
planche à découper



Buchen-Holz

beech
haya
hêtre

	cm	↑ cm	€
00953	52 x 34	2	33,00

	cm	↑ cm	€
83615	59,5 x 35,5	3,5	37,00





Chafing Dish, GN Container & Transport

Chafing Dish
Suppentöpfe
Heizelemente
GN-Behälter
Servier-/Transportwagen

chafing dish
marmitas de sopa
resistencias
GN cubetas
carro de servicio

chafing dish
soup warmers
heating units
GN-container
serving trolley

chafing dish
marmites à soup
résistances
GN bacs
chariot de service

EASY INDUCTION



die Deckelbremse sorgt für langsames Schließen

the revolving cover closes gently, thanks to a special built-in axle

sistema de freno para un cierre suave de la tapa

système avec frein pour une fermeture en douceur du couvercle



Druckhebel zum leichten Entnehmen des GN-Behälters

stick for easy removing of the GN-container

dispositivo para levantar y quitar con facilidad la cubeta GN

dispositif pour lever et retirer facilement le bac GN



abnehmbarer Glas-Deckel mit Wasserrücklaufsystem

removable glass lid, with water-runback-system

tapa transparente desmontable con sistema de retorno de la condensación

couvercle transparent amovible avec système de retour de la condensation



Fixierschraube verhindert das Rutschen



fixing screw for skid resistance

Pie trasero anti-deslizante, altura regulable

Pied supplémentaire anti-dérapant réglable en hauteur

Lieferung ohne Induktionskochplatte
delivery without induction plate
se entrega sin placa de inducción
livré sans plaque à induction

GN 1/1 Chafing Dish „EASY INDUCTION“

1 Gestell + 1 Wasserbecken mit Sandwichboden + 1 Deckel mit hydraulischem Gelenk + 1 GN 1/1 Behälter 65 mm tief, hitzebeständige Griffe, hochwertige Verarbeitung, ausschließlich für Induktionskochfelder

1 frame + 1 waterpan with sandwich base + 1 hydraulic cover + 1 GN 1/1 container 65 mm, heat-resistant handles, high quality, only for induction plates



1 marco + 1 baño maría con base sandwich + 1 marco con tapa hidráulica + 1 cubeta GN 1/1 pan 65 mm profundo, asas resistentes al calor, buenos acabados, solamente para inducción

1 pied support + 1 bac bain-marie avec fond sandwich + 1 cadre avec couvercle hydraulique + 1 bac GN 1/1 - 65mm, poignées résistantes à la chaleur, belle qualité, uniquement pour induction

	cm	↑ cm	GN	litr.	€
12322	60 x 42	30	1/1	9	460,00

Lieferung ohne Induktionskochplatte
delivery without induction plate
se entrega sin placa de inducción
livré sans plaque à induction

GN 2/3 Chafing Dish „EASY INDUCTION“

1 Gestell + 1 Wasserbecken mit Sandwichboden + 1 Wasserbeckenrahmen + 1 Deckel mit hydraulischem Gelenk + 1 GN 2/3 Behälter 65 mm tief, hitzebeständige Griffe, hochwertige Verarbeitung, ausschließlich für Induktionskochfelder

1 frame + 1 waterpan with sandwich base + 1 frame for waterpan + 1 hydraulic cover + 1 GN 2/3 container 65 mm, heat-resistant handles, high quality, only for induction plates

1 marco + 1 baño maría con base sandwich + 1 marco con tapa hidráulica + 1 cubeta GN 2/3 pan 65 mm profundo, asas resistentes al calor, buenos acabados, solamente para inducción

1 pied support + 1 bac bain-marie avec fond sandwich + 1 cadre avec couvercle hydraulique + 1 bac GN 2/3 - 65mm, poignées résistantes à la chaleur, belle qualité, uniquement pour induction

	cm	↑ cm	GN	litr.	€
12323	42 x 41	30	2/3	5,5	390,00



Lieferung ohne Induktionskochplatte
delivery without induction plate
se entrega sin placa de inducción
livré sans plaque à induction

Chafing Dish „EASY INDUCTION“



1 Gestell + 1 Wasserbecken mit Sandwichboden + 1 Deckel mit hydraulischem Gelenk + 1 runder Speisenbehälter, hitzebeständige Griffe, hochwertige Verarbeitung, ausschließlich für Induktionskochfelder geeignet

1 frame + 1 waterpan with sandwich base + 1 hydraulic cover + 1 round foodpan, heat-resistant handles, high quality, good for induction plates

1 soporte + 1 baño maría con base sandwich + 1 tapa hidráulica + 1 cubeta redonda, asas resistente al calor, buen acabado, apto para inducción

1 pied support + 1 bac bain-marie avec fond sandwich + 1 cadre avec couvercle hydraulique + 1 bac rond, poignées résistante à la chaleur, belle qualité, uniquement pour induction

	cm	↑ cm	ltr.	€
12324	46 x 50	30	6	380,00



Lieferung ohne Induktionskochplatte
delivery without induction plate
se entrega sin placa de inducción
livré sans plaque à induction

Chafing Dish „EASY INDUCTION“



1 Gestell + 1 Wasserbecken mit Sandwichboden + 1 Deckel mit hydraulischem Gelenk + 1 runder Speisenbehälter, hitzebeständige Griffe, hochwertige Verarbeitung, ausschließlich für Induktionskochfelder geeignet

1 frame + 1 waterpan with sandwich base + 1 hydraulic cover + 1 round foodpan, heat-resistant handles, high quality, good for induction plates

1 soporte + 1 baño maría con base sandwich + 1 tapa hidráulica + 1 cubeta redonda, asas resistente al calor, buen acabado, apto para inducción

1 pied support + 1 bac bain-marie avec fond sandwich + 1 cadre avec couvercle hydraulique + 1 bac rond, poignées résistante à la chaleur, belle qualité, uniquement pour induction

	cm	↑ cm	ltr.	€
12325	48 x 42	39	11	380,00



Induktionskochplatte für Chafing Dish

induction plate for chafing dish
placa de inducción para chafing dish
plaque à induction pour chafing dish

mit Regler
with power control
con control de potencia
avec régulateur

	Ø cm	W	€
12295	24	900 W	129,00



82215
2 x 2 Ltr.

Porzellan-Einsatz
porcelain insert
bandeja de porcelana
bac supérieur en porcelaine



	Ø cm	↑ cm	ltr.	fits to	€
82210	39	6	4,3	12324	70,00
82215	39	6	4,0	12324	72,00

PREMIUM



langlebige Deckelbremse
Abnehmbarer Deckel, dieser lässt sich spielend leicht öffnen und schliessen, der Lauf des Deckels wird professionell gedämpft.



Kondenswasser - Rücklaufsystem
Kondenswasser wird in das Wasserbecken zurückgeführt.



Sandwichboden / Kapselboden
Induktionsfähiger Boden, direkt auf dem Induktionskochfeld einsetzbar. Perfekte Wärmeverteilung und Steuerung.



Fixierschraube / Rutschsicherung
Höhenverstellbares Gelenk, fixiert das Gerät in dem Gestell und auf dem Tisch.



Induktionskochplatte Nr. 12295
Induktionskochplatte wird einfach in das Gestell gelegt.



stapelbar
Chafing Dish Rahmen sind übereinander stapelbar. Platzsparend und rutschfest stapeln und transportieren.



Induktionskochplatte für Chafing Dish

induction plate for chafing dish
placa de inducción para chafing dish
plaque à induction pour chafing dish

mit Regler
with power control
con control de potencia
avec régulateur

	Ø cm		€
12295	24	900 W	129,00



Lieferung ohne Induktionskochplatte
delivery without induction plate
se entrega sin placa de inducción
livré sans plaque à induction

GN 1/1 Chafing Dish „PREMIUM“



1 Gestell + 1 Wasserbecken mit Sandwichboden + 1 Wasserbeckenrahmen + 1 Deckel mit hydraulischem Gelenk + 1 GN 1/1 Behälter 65 mm tief, hitzebeständige Griffe, hochwertige Verarbeitung, ausschließlich für Induktionskochfelder

1 frame + 1 waterpan with sandwich base + 1 frame for waterpan + 1 hydraulic cover + 1 GN 1/1 container 65 mm, heat resistant handles, high quality, only for induction plates

1 soporte + 1 cubeta baño maría con base sandwich + 1 marco para cubeta baño maría + 1 tapa hidráulica + 1 cubeta GN 1/1 de 65 mm, asas resistentes al calor, acabado de alta calidad, solamente para inducción

1 pied support + 1 bac bain-marie avec fond sandwich + 1 cadre pour bac bain-marie + 1 couvercle hydraulique + 1 bac GN 1/1 de 65 mm, poignées résistantes à la chaleur, finition de qualité, uniquement pour induction

	cm	↑ cm	ltr.		€
12370	66 x 48	33	9	mit Edelstahldeckel with stainless cover	894,00
12352	66 x 48	33	9	mit Glasdeckel with glass cover	1140,00



Lieferung ohne Induktionskochplatte
delivery without induction plate
se entrega sin placa de inducción
livré sans plaque à induction

Chafing Dish rund „PREMIUM“



1 Gestell + 1 Wasserbecken mit Sandwichboden + 1 Wasserbeckenrahmen + 1 Deckel mit hydraulischem Gelenk + 1 runder Speisenbehälter, hitzebeständiger Griff, hochwertige Verarbeitung, für Induktionskochfelder geeignet

1 frame + 1 waterpan with sandwich base + 1 frame for waterpan + 1 hydraulic cover + 1 round foodpan, heat resistant handle, high quality, suitable for induction plates

1 soporte + 1 cubeta baño maría con base sandwich + 1 marco para cubeta baño maría + 1 tapa hidráulica + 1 cubeta redonda, asa resistente al calor, acabado de alta calidad, apto para inducción

1 pied support + 1 bac bain-marie avec fond sandwich + 1 cadre pour bac bain-marie + 1 couvercle hydraulique + 1 bac rond, poignée résistante à la chaleur, finition de qualité, apte pour induction

	cm	↑ cm	ltr.		€
12371	44 x 54	33	6	mit Edelstahldeckel with stainless cover	780,00
12353	44 x 54	33	6	mit Glasdeckel with glass cover	890,00

Speiseneinsatz / foodpan / cubeta / bac supérieur

	€
12366	24,00



Lieferung ohne Induktionskochplatte
delivery without induction plate
se entrega sin placa de inducción
livré sans plaque à induction

Chafing Dish rund „PREMIUM“



1 Gestell + 1 Wasserbecken mit Sandwichboden + 1 Wasserbeckenrahmen + 1 Deckel mit hydraulischem Gelenk + 1 runder Speisenbehälter, hitzebeständige Griffe, hochwertige Verarbeitung, für Induktionskochfelder geeignet

1 frame + 1 waterpan with sandwich base + 1 frame for waterpan + 1 hydraulic cover + 1 round foodpan, heat resistant handles, high quality, suitable for induction plates

1 soporte + 1 cubeta baño maría con base sandwich + 1 marco para cubeta baño maría + 1 tapa hidráulica + 1 cubeta redonda, asas resistentes al calor, acabado de alta calidad, apto para inducción

1 pied support + 1 bac bain-marie avec fond sandwich + 1 cadre pour bac bain-marie + 1 couvercle hydraulique + 1 bac rond, poignées résistantes à la chaleur, finition de qualité, apte pour induction

	cm	↑ cm	ltr.		€
12372	44 x 48	39	10	mit Edelstahldeckel with stainless cover	780,00
12354	44 x 48	39	10	mit Glasdeckel with glass cover	890,00

Speisenbehälter / foodpan / cubeta superior / bac supérieur

	€
12397	18,00

GLOBE



die Deckelbremse sorgt für langsames Schließen

the revolving cover closes gently, thanks to a special built-in axle

resistencia los frenos del sistema garantizan un cierre suave de la tapa

système avec frein pour une fermeture en douceur du couvercle



abnehmbarer Deckel mit Wasserrücklaufsystem

lid can be taken off, with water runback system

tapa fácil de desmontar, y canal incorporado para recuperar el agua condensada

couvercle facile à démonter, rainure pour récupérer les gouttes de condensation



Kondenswasser wird in das Wasserbecken zurückgeführt

condensed water is led back into the waterpan

el agua de condensación vuelve a la cubeta de agua

l'eau de condensation retourne dans le bac d'eau



für alle Herdarten geeignet, auch für Induktionskochplatten

suitable for all kinds of ovens, even induction cookers

apto para todas las fuentes de calor, incluso inducción

apte pour toutes les sources de chaleur, y compris induction



GN 1/1 Chafing Dish „GLOBE“



hochglanzpoliert, mit abnehmbarem hydraulischen Edelstahl-Deckel, Sandwichboden sorgt für optimale Wärmeleitung, für Induktionsplatten geeignet, Set: Gestell + Wasserbecken + Speisenbehälter GN 1/1 65 mm tief, 9 Liter + Löffelablage + 2 Brennpastenbehälter + Metallrahmen für Induktionskochplatte

mirror polished finish, removable stainless steel hydraulic cover, sandwich base for optimum heat distribution, suitable for induction plates

set: frame + waterpan + GN 1/1 container 65 mm, 9l + cutlery compartment ladles + 2 burner holder + frame for induction plate

pulido brillante, tapa hidráulica de acero inoxidable extraíble, fondo difusor sandwich apto para inducción, incluye: soporte + cubeta baño maría + cubeta GN 1/1 de 65 mm, 9l + soporte para cuchara (sin cuchara) + 2 quemadores + marco para la placa de inducción

poli brillant, couvercle inox hydraulique amovible, fond diffuseur sandwich apte pour induction, comprend: pied support + bac bain-marie + bac GN 1/1 de 65 mm, 9l + porte-louche (louche non incluse) + 2 brûleurs + cadre inox pour la plaque à induction

	cm	↑ cm	ltr.		€
12394	66,5 x 44,0	34	9	mit Edelstahldeckel with stainless cover	556,00
12404	66,5 x 44,0	34	9	mit Glasdeckel with glass cover	556,00
Deckel mit Glasfenster / cover with glass insert / tapa con cristal / couvercle inox et verre					€
12391					234,00
Deckel Edelstahl / cover stainless steel / tapa de acero inoxidable / couvercle tout inox					€
12386					234,00
Induktionskochplatte für Chafing Dish / induction plate for chafing dish / placa de inducción para chafing dish / plaque à induction pour chafing dish					€
12295					129,00
Metallrahmen für Induktionskochplatte / frame for induction plate / estructura o marco para placa de inducción / cadre support inox pour plaque induction					€
12296					18,00



Suppen-Kugel inkl. Gestell „GLOBE“

soup bowl with stand
cubeta sopa con soporte
récipient à soupe avec pied



hochglanzpoliert, inkl. Speisenbehälter, 1 Brennpastenbehälter, mit einhängbarer Löffelablage, Sandwichboden sorgt für optimale Wärmeverteilung, für Induktionsplatten geeignet, einfaches Anbringen und Entfernen des Deckels, hitzeisolierende Griffe, 1 Metallrahmen für Induktionskochplatten

mirror polished finish, incl. foodpan and 1 burner holder, with fitting compartment for ladles, sandwich bottom for optimum heat distribution, gentle opening of the lid, heat-resistant handles, frame for induction plate

acabado pulido brillante, cubeta sopa inox, 1 quemador, platillo a colgar para el cucharón, fondo difusor sandwich, apto para inducción, tapa con apertura controlada, asas frías, marco para placa de inducción

poli brillant, récipient à soupe inox, 1 brûleur, repose-couvert à accrocher, fond diffuseur sandwich, apte pour induction, couvercle à ouverture contrôlée, anses froides, cadre support inox pour plaque à induction

	Ø cm	↑ cm	ltr.	€
12398	48	45	10	429,00

Induktionskochplatte für Chafing Dish / induction plate for chafing dish / placa de inducción para chafing dish / plaque à induction pour chafing dish

12295				€ 129,00
-------	--	--	--	----------

Metallrahmen für Induktionskochplatten / frame for induction plate / marco para placa de inducción / cadre support inox pour plaque induction

12291				€ 17,00
-------	--	--	--	---------



Suppen-Kugel „GLOBE“

soup bowl
cubeta sopa
récipient à soupe



hochglanzpoliert, inkl. Speisenbehälter, mit einhängbarer Löffelablage, Sandwichboden sorgt für optimale Wärmeverteilung, für Induktionsplatten geeignet, einfaches Anbringen und Entfernen des Deckels, hitzeisolierende Griffe (Lieferung ohne Gestell, Löffel)

mirror polished finish, incl. foodpan, with fitting compartment for ladles, sandwich bottom for optimum heat distribution, gentle opening of the lid, heat-resistant handles (delivery without rack, ladle)

acabado pulido brillante, cubeta sopa inox, platillo a colgar para el cucharón, fondo difusor sandwich, apto para inducción, tapa con apertura controlada, asas frías (cucharón no incluido)

poli brillant, récipient à soupe inox, repose-couvert à accrocher, fond diffuseur sandwich, apte pour induction, couvercle à ouverture contrôlée, anses froides (cadre, louche non incluse)

	Ø cm	↑ cm	ltr.	€
12399	48	32	10	374,00

Gestell inkl. Brenner / frame incl. burner / soporte incluyendo quemador / support, brûleur inclus

12396				€ 62,00
-------	--	--	--	---------

Speisenbehälter / foodpan / cubeta superior / bac supérieur

12397				€ 18,00
-------	--	--	--	---------



Chafing Dish „GLOBE“



hochglanzpoliert, mit abnehmbarem hydraulischen Edelstahl-Deckel, Sandwichboden sorgt für optimale Wärmeleitung, für Induktionsplatten geeignet

Set: Gestell + Wasserbecken + Speisenbehälter rund + Löffelablage + Brennpastenbehälter + Metallrahmen für Induktionskochplatte

mirror polished finish, removable hydraulic cover, sandwich base, optimum heat distribution set: frame + waterpan + foodpan round + cuttlery compartment ladles + burner holder + frame for induction plate

pulido brillante, con tapa hidráulica extraíble, fondo difusor sandwich apto para inducción. Incluye: 1 pie, 1 cubeta baño maría, 1 cubeta redonda, 1 soporte para cuchara (sin cuchara), 1 quemador, marco inox para la placa de inducción

brillant, couvercle hydraulique amovible, fond diffuseur sandwich apte pour induction. Comprend: pied, cuve bain-marie, bac inox rond, porte-louche (louche non incluse), 1 brûleur, cadre inox pour la plaque à induction

	Ø cm	↑ cm	ltr.		€
12393	38,5	34	6	mit Edelstahldeckel with stainless cover	478,00
12403	38,5	34	6	mit Glasdeckel with glass cover	484,00

Deckel mit Glasfenster / cover with glass insert / tapa con cristal / couvercle inox et verre

12390					220,00
-------	--	--	--	--	--------

Deckel Edelstahl / cover stainless steel / tapa de acero inoxidable / couvercle tout inox

12385					220,00
-------	--	--	--	--	--------

Induktionskochplatte für Chafing Dish / induction plate for chafing dish / placa de inducción para chafing dish / plaque à induction pour chafing dish

12295					129,00
-------	--	--	--	--	--------

Metallrahmen für Induktionskochplatten / frame for induction plate / marco para placa de inducción / cadre support inox pour plaque induction

12291					17,00
-------	--	--	--	--	-------

Speiseneinsatz / foodpan / cubeta / bac supérieur

12366					24,00
-------	--	--	--	--	-------



Porzellan-Einsatz

porcelain insert
bandeja de porcelana
bac supérieur en porcelaine



	Ø cm	↑ cm	ltr.	fits to	€
82210	39	6	4,3	12393, 12403	70,00
82215	39	6	4,0	12393, 12403	72,00



GN 2/3 Chafing Dish „GLOBE“



hochglanzpoliert, mit abnehmbarem hydraulischen Edelstahl-Deckel, Sandwichboden sorgt für optimale Wärmeleitung, für Induktionsplatten geeignet, Set: Gestell + Wasserbecken + 1 GN 2/3 Behälter 65 mm tief + Löffelablage + 1 Brennpastenbehälter + 1 Metallrahmen für Induktionskochplatte

mirror polished finish, removable hydraulic cover, sandwich base, optimum heat distribution, set: frame + waterpan + foodpan GN 2/3, 65 mm, 5,5 l + compartment for ladles + burner holder + frame for induction plate

pulido brillante, con tapa hidráulica extraíble, fondo difusor sandwich apto para inducción. Incluye: 1 pie, 1 cubeta baño maría, 1 cubeta GN 2/3 65 mm - 5,5 l, 1 soporte para cuchara (sin cuchara), 1 quemador, marco inox para la placa de inducción

poli brillant, couvercle hydraulique amovible, fond diffuseur sandwich apte pour induction. Comprend: pied, cuve bain-marie, bac inox GN 2/3-65 mm - 5,5 L, porte-louche (louche non incluse), brûleur, cadre inox pour la plaque à induction

	cm	↑ cm	ltr.		€
12483	44 x 41	34	5,5	mit Edelstahl-Deckel with stainless steel cover	498,00
12484	44 x 41	34	5,5	mit Glasdeckel with glass cover	498,00



Rolltop-Chafing Dish „ELITE“



poliert, Rolltop-Deckel klappbar auf 90° und 180°, Speisenbehälter GN 1/1 65 mm tief + Wasserbecken + 2 Brennpastenbehälter, wechseln des GN-Behälters ohne abnehmen des Deckels (kein Kondenswasser-Rücklaufsystem)

polished, rolltop cover adjustable at 90° and 180°, foodpan GN 1/1 65 mm deep + waterpan + 2 burner holders, change of the GN container without removing the lid (condensed water can not be led back into the waterpan)

pulido brillante, tapa rolltop a 90° o 180°, cubeta GN 1/1 + 2 quemadores, cuba baño maría, se puede cambiar la cubeta GN sin retirar la tapa, importante: el agua condensada no revierte en los alimentos

poli brillant, couvercle rolltop ouverture de 90 a 180°, bac GN 1/1, bain-marie, 2 brûleurs, le bac GN peut être retiré et remplacé sans démonter le couvercle, important: la condensation ne retombe pas sur les aliments

	cm	↑ cm	ltr.		€
12350	67 x 47	45	9		229,00

Wasserbecken inkl. Vorrichtung für Heizelement / waterpan / baño maría / bain-marie

12249					38,40
-------	--	--	--	--	-------



inkl. Vorrichtung für Heizelement
incl. screws for heating unit



Rolltop-Chafing Dish „MAESTRO“



Speisenbehälter GN1/1 65 mm tief (passend auch für 100 mm) + Rolltop-Deckel 90° + Wasserbecken inkl. Vorrichtung für Heizplatte + 2 Brennpastenbehälter

foodpan GN1/1 65 mm (also for 100 mm) + rolltop cover 90° + waterpan with screws for heating unit + 2 burner holders

cubeta GN 1/1 - 65 mm (hay espacio para una cubeta 100 mm) + campana rolltop abatible a 90° + 2 quemadores

bac GN 1/1 - 65 mm (accepte aussi bac ht. 100 mm) + couvercle rolltop ouverture 90° + 2 brûleurs

	cm	↑ cm	ltr.		€
12300	67 x 35	45	9		189,00



inkl. Vorrichtung für Heizelement
incl. screws
for heating unit

Rolltop-Chafing Dish „WINDOW“



poliert, Rolltop-Deckel klappbar auf 90° und 180°, Speisenbehälter 65 mm tief + Wasserbecken + 2 Brennpastenbehälter, wechseln des Behälters ohne abnehmen des Deckels (kein Kondenswasser-Rücklaufsystem)

polished, rolltop cover adjustable at 90° and 180°, foodpan 65 mm deep + waterpan + 2 burner holders, change of the container without removing the lid (condensed water can not be led back into the waterpan)

pulido brillante, tapa rolltop a 90° o 180°, cubeta de 65 mm+ 2 quemadores, cuba baño maría. Se puede cambiar la cubeta sin retirar la tapa. Importante: el agua condensada no revierte en los alimentos

poli brillant, couvercle rolltop ouverture de 90° a 180°, bac de 65 mm, bain-marie, 2 brûleurs. Le bac peut être retiré et remplacé sans démonter le couvercle. Important: la condensation ne retombe pas sur les aliments.

	cm	↑ cm	ltr.		€
12320	64 x 46	44	9	GN 1/1	240,00
12321	Ø 48	46	6		190,00

Elektro-Heizelement / heating unit / resistencia / résistance

		€
12290	360 W / 140 - 250 V	116,00
12292	600 W / 230 V	120,00
12294	800 W / 230 V	162,00

Wasserbecken inkl. Vorrichtung für Heizelement / waterpan / baño maría / bain-marie

	€
12249	38,40



wechseln des GN-Behälters ohne Abnehmen des Deckels
(kein Kondenswasser-Rücklaufsystem)

Chafing Dish „CATERER PRO“



Deckel hochglanzpoliert, Deckelgriffe hitzebeständig + 2 Brennpastenbehälter + Wasserbecken, inkl. Vorrichtung für Heizplatte + Gestell mit Deckelhalterung (ohne GN Speisenbehälter)

cover mirror polished finish, cover knob heat-resistant + 2 burner holders + waterpan with screws for heating unit + frame with coverholder (without GN foodpan)

tapa pulido brillante, asas frías + 2 quemadores + cuba inferior con tornillos para resistencia removable (no incluida) + tapa y estructura con sujeción de la tapa (se sirve sin la cubeta GN)

couvercle poli brillant, anses froides + 2 brûleurs + bac bain-marie avec fixations pour résistance amovible (non incluse)

	cm	↑ cm	€
12233	64 x 35	34	139,00

Ersatzdeckel / replacement cover / tapa de recambio / couvercle de rechange

	€
12236	36,00

Wasserbecken inkl. Vorrichtung für Heizelement / waterpan / baño maría / bain-marie

	€
12249	38,40



inkl. Vorrichtung für Heizelement
incl. screws
for heating unit



Chafing Dish „CATERER“



Speisenbehälter GN 1/1 65 mm tief + 2 Brennpastenbehälter + Wasserbecken inkl. Vorrichtung für Heizelement + Deckel + Gestell mit Deckelhalterung (Lieferung ohne Heizelement)

foodpan GN 1/1 65 mm deep + 2 burner holders + 1 waterpan with screws for heating unit + cover + frame with coverholder (without heating unit)

1 cubeta GN 1/1 - 65 mm + 2 quemadores + cuba baño maría con fijaciones para resistencia amovible + estructura con bloqueo tapa (se sirve sin la resistencia)

1 bac GN 1/1 - 65 mm + 2 brûleurs + 1 bac bain-marie avec 4 vis pour fixation d'une résistance de chauffe amovible (non incluse) + couvercle + chassis avec blocage couvercle

	cm	↑ cm	ltr.	€
12240	67 x 35	35	9	147,00

Ersatzdeckel / replacement cover / tapa de recambio / couvercle de rechange

12260				34,00
-------	--	--	--	-------

Wasserbecken inkl. Vorrichtung für Heizelement / waterpan / baño maría / bain-marie

12249				38,40
-------	--	--	--	-------



Rolltop-Chafing Dish „CATERER“



Speisenbehälter GN 1/1 65 mm tief + Rolltop-Deckel 90° + Wasserbecken inkl. Vorrichtung für Heizplatte + 2 Brennpastenbehälter (Lieferung ohne Heizplatte), massiver Ständer

foodpan GN 1/1 65 mm deep + rolltop cover 90° + waterpan with screws for heatingunit + 2 burner holders (without heating unit), stable frame

1 cubeta GN 1/1 - 65 mm + campana rolltop abatible a 90° + 2 quemadores + cuba baño maría con fijaciones para resistencia amovible (se sirve sin la resistencia)

1 bac GN 1/1 - 65 mm + couvercle rolltop ouverture 90° + 2 brûleurs + 1 bac bain-marie avec 4 vis pour fixation résistance de chauffe amovible (non incluse)

	cm	↑ cm	ltr.	€
12245	67 x 35	45	9	219,00

Wasserbecken inkl. Vorrichtung für Heizelement / waterpan / baño maría / bain-marie

12249				38,40
-------	--	--	--	-------



inkl. Vorrichtung für Heizelement
incl. screws
for heating unit



hot price

Chafing Dish „CHEF“



Speisenbehälter GN 1/1 65 mm tief + 2 Brennpastenbehälter + Wasserbecken + Deckel + Gestell mit Deckelhalterung + langer Hohlgriff

foodpan GN 1/1 65 mm + 2 burner holders + waterpan + cove + frame with coverholder

1 cubeta GN 1/1 65 mm + 2 quemadores + cubeta para el agua + tapa y chasis con bloqueo para la tapa

1 bac GN 1/1 - 65 mm + 2 brûleurs + 1 bac bain-marie + couvercle + chassis avec blocage couvercle + poignée tube creux

	cm	↑ cm	ltr.	€
11675	61 x 31	30	9	66,00



Chafing Dish „ECONOMIC“



Speisenbehälter GN 1/1 65mm tief + 2 Brennpastenbehälter + Wasserbecken + Deckel, Gestell mit Deckelhalterung

foodpan GN 1/1 65 mm + 2 burner holders + waterpan + cover, frame with coverholder
 cubeta GN 1/1 65 mm + 2 quemadores+ cubeta para el agua + bloqueo para la tapa
 bac GN 1/1 65 mm + 2 brûleurs + bac bain-marie + couvercle + chassis avec blocage couvercle

	cm	↑ cm	ltr.		€
11680	61 x 36	30	9		63,00
11680	61 x 36	30	9	> 20 Stk. / pcs.	60,00
11618	61 x 36	30		ohne Speisenbehälter / without foodpan sin la cubeta / sans le bac GN	49,60



Chafing Dish „TWIN“, 2er Set



komplette Sets, inkl. GN 1/1 Speisenbehälter 65 mm tief

complete sets, incl. GN 1/1 foodpan 65 mm deep
 2 chafing dish completos con cubetas GN 1/1
 2 chafing dish complets avec bacs GN 1/1

	cm	↑ cm	ltr.		€
11699	61 x 36	30	9	2 pcs.	99,00



Chafing Dish „CHEF“



Speisenbehälter + Wasserbecken + 1 Brennpastenbehälter + Deckel + Gestell

foodpan + waterpan + 1 burner holder + cover + frame
 cubeta redonda + baño maría + 1 quemador + tapa + soporte
 récipient + bain-marie + 1 brûleur + couvercle + support

	Ø cm	↑ cm	ltr.	€
11692	34	34	7,5	64,00

Speisebehälter / foodpan / cubeta / bac supérieur

11658				18,00
-------	--	--	--	-------



Suppentopf „HOT POT“



hot pot / soup pot
 olla para buffet
 marmite de buffet

Speisenbehälter + Wasserbecken + 1 Brennpastenbehälter + Deckel + Gestell

foodpan + waterpan + 1 burner holder + cover + frame
 cubeta + baño maría + 1 quemador + tapa + soporte
 récipient + bain-marie + 1 brûleur + couvercle + support

	Ø cm	↑ cm	ltr.	€
11678	33	35	13,5	79,00



praktischer Halter für den Deckel
included cover holder

Chafing Dish „VEGGIE“



Speisenbehälter + Wasserbecken + 1 Brennpastenbehälter + Deckel + Gestell
foodpan + waterpan + 1 burner holder + cover + frame
cubeta redonda + baño maría + quemador + tapa + soporte
récipient + bain marie + brûleur + couvercle + support

	Ø cm	↑ cm	ltr.	€
11693	35	28	4	39,00



praktischer Ausgießer
included lid

Butter- und Saucenwärmer



butter and sauce pan warmer
calentador de mantequilla y salsa
réchaud à beurre et sauce

Saucentopf mit Ausgießer + Deckel + Gestell (passend für 1 Teelicht)

pan with spout + lid + riser (for 1 light)
cacerola + tapadera + soporte (para 1 vela)
petite casserole avec bec verseur + couvercle + support (pour 1 bougie)

	Ø cm	↑ cm	ltr.	€
35350	14	16	0,7	15,00

Griff: 13,5 cm / handle: 13,5 cm
asa: 13,5 cm / poignée: 13,5 cm



Speisenwärmer „PROFI“



plate warmer
calienta platos
chauffe-plat

Rahmen aus Edelstahl mit Aluminium-Wärmeplatte

stainless steel frame, thick aluminium plate
soporte inox con placa de aluminio
support inox avec plaque aluminium

	cm	↑ cm	€
35050	33 x 18	7	41,00

2 Teelichter / 2 tealights
2 velas / 2 bougies



hot price

Speisenwärmer



warmer
calienta platos
chauffe-plat

3-flammig

3 lights
3 velas
3 bougies

	cm	↑ cm	€
35065	34 x 18	6	17,00



hot price

Speisenwärmer



warmer
calienta platos
chauffe-plat

2-flammig, matt poliert

2 lights, satin polished finish
2 velas, acero inoxidable acabado mate
2 bougies, inox finition mate

	cm	↑ cm	€
35343	34 x 13	6	13,00



GN 1/1 100 mm
14 ltr.

Elektro-Rolltop-Chafing Dish „ELITE“

electric rolltop chafing dish
chafing dish eléctrico rolltop
chafing dish électrique rolltop



poliert, Rolltop-Deckel klappbar auf 90° und 180°, Elektro-Wasserbecken mit Temperaturregelung + Speisenbehälter GN 1/1 100 mm tief, 220 - 240 V ~ 50 Hz; 760 - 900 W (kein Kondenswasser-Rücklaufsystem)

polished, rolltop cover adjustable at 90° and 180°, electric waterpan with adjustable heatcontrol + foodpan GN 1/1 100 mm deep, voltage 220 - 240 V ~ 50 Hz, power consumption 760 - 900 W (condensed water cannot be led back into the waterpan)

pulido brillante, tapa abatible apertura a 90° o 180°, baño maría c/ termostato + cubeta GN 1/1 - 100 mm, 220-240 V-50 Hz. Consumo 760-900 W (el agua condensada no gotea dentro de la cubeta)

poli brillant, couvercle rolltop ouverture à 90° ou 180°, bain-marie électrique avec thermostat + bac GN 1/1-100 mm, 220-240 V - 50 Hz; 760-900 W (Important: la condensation ne retombe pas sur les aliments)

	cm	↑ cm	ltr.	€
12360	67 x 47	45	14	376,00



Elektro-Rolltop-Chafing Dish „ELITE“

electric rolltop chafing dish
chafing dish eléctrico rolltop
chafing dish électrique rolltop



poliert, Rolltop-Deckel klappbar auf 90° und 180°, Elektro-Wasserbecken mit Temperaturregelung + Speisenbehälter, 220 - 240 V ~ 50 Hz; 420 - 500 W (kein Kondenswasser-Rücklaufsystem)

polished, rolltop cover adjustable at 90° and 180°, electric waterpan with adjustable heatcontrol + foodpan, voltage 220 - 240 V ~ 50 Hz, power consumption 420 - 500 W (condensed water cannot be led back into the waterpan)

pulido brillante, tapa abatible apertura a 90° o 180°, baño maría c/ termostato - 220-240 V-50 Hz. 420-500 W (el agua condensada no gotea dentro de la cubeta)

poli brillant, couvercle rolltop ouverture à 90° ou 180°, bain-marie électrique avec thermostat, 220-240 V - 50 Hz; 420-500 W (Important: la condensation ne retombe pas sur les aliments)

	Ø cm	↑ cm	ltr.	€
12356	45	45	6,8	270,00

Speisenbehälter / foodpan / cubeta superior / bac supérieur

12357				38,00
-------	--	--	--	-------



Rolltop-Chafing Dish „ELITE“



poliert, Rolltop-Deckel klappbar auf 90° und 180° + Speisenbehälter + Wasserbehälter inkl. Vorrichtung für Heizplatte + 1 Brennpastenbehälter, Hohlgriff kann nicht heiß werden, wechseln des Behälters ohne abnehmen des Deckels (kein Kondenswasser-Rücklaufsystem)

polished, rolltop cover adjustable at 90° and 180° + foodpan + 1 burner holder, waterpan with screws for heating unit (not included), change of the container without removing the lid (condensed water can not be led back into the waterpan)

pulido brillante, tapa rolltop a 90° o 180°, cubeta + 1 quemadores, cuba baño maría con fijaciones para resistencia (se sirve sin la resistencia), se puede cambiar la cubeta GN sin retirar la tapa, importante: el agua condensada no revierte en los alimentos

poli brillant, couvercle rolltop ouverture de 90° a 180°, bac, bain-marie avec 4 vis pour fixation résistance de chauffe amovible (non incluse), 2 brûleurs, le bac GN peut être retiré et remplacé sans démonter le couvercle, important: la condensation ne retombe pas sur les aliments

	Ø cm	↑ cm	ltr.	€
12355	45	45	5	175,00



Elektro-Chafing Dish „INOXSTAR“

electric chafing dish
chafing dish eléctrico
chafing dish électrique



poliert, Thermostat-Regelung, Speisenbehälter GN 1/1 100 mm tief, Deckelhalter, 900 W, 230 V
polished, thermostat control, foodpan GN 1/1 100 mm deep, lid holder, 900 W, 230 V
pulido brillante, termostato de control, cubeta GN 1/1-100 mm, bloqueo para la tapa, 900 W, 230 V
poli brillant, thermostat, bac GN 1/1-100 mm, blocage du couvercle, 900 W, 230 V

	cm	↑ cm	ltr.	€
12222	62 x 35	29	13,5	199,00

Deckel / cover / tapa / couvercle

12235				30,00
-------	--	--	--	-------



Elektro Chafing Dish

electric chafing dish
chafing dish eléctrico
chafing dish électrique



Speisenbehälter GN 1/1 100 mm tief, Deckelhalter, Thermostat-Regelung 900 W, 230 V
foodpan GN 1/1 100 mm deep, lid holder, thermostat control 900 W, 230 V
cubeta GN 1/1-100 mm, sujeción de la tapa, termostato, 900W, 230 V
bac GN 1/1-100 mm, blocage du couvercle, thermostat, 900W, 230 V

	cm	↑ cm	ltr.	€
12225	63 x 36	29	14	154,00

Deckel / cover / tapa / couvercle

12235				30,00
-------	--	--	--	-------



Elektro-Chafing Dish „ECO“

electric chafing dish
chafing dish eléctrico
chafing dish électrique



Deckel poliert, Elektro-Wasserbecken mit Temperaturregelung + Speisenbehälter GN 1/1 65 mm tief, 220 - 240 V ~ 50 Hz; 760 - 900 W

cover polished, electric waterpan with adjustable heatcontrol + foodpan GN 1/1 65 mm deep, voltage 220 - 240 V ~ 50 Hz, power consumption 760 - 900 W

tapa pulido brillante, baño maría c/ termostato + cubeta GN 1/1 - 65 mm - 220-240 V-50 Hz. / 760-900 W

couvercle poli brillant, bain-marie électrique avec thermostat + bac GN 1/1-65 mm, 220-240 V - 50 Hz; 760-900 W

	cm	↑ cm	ltr.	€
12232	63 x 36	29	9	125,00



Elektro-Chafing Dish „ECO“

electric chafing dish
chafing dish eléctrico
chafing dish électrique



Glasdeckel (Rand poliert), Elektro-Wasserbecken mit Temperaturregelung + Speisenbehälter, 220 - 240 V ~ 50 Hz; 420 - 500 W

cover polished, electric waterpan with adjustable heatcontrol + foodpan, voltage 220 - 240 V ~ 50 Hz, power consumption 420 - 500 W

tapa vidrio borde pulido brillante, baño maría c/ termostato - 220-240 V-50 Hz. 420-500 W

couvercle verre bord poli brillant, bain-marie électrique avec thermostat, 220-240 V - 50 Hz; 420-500 W

	Ø cm	↑ cm	ltr.	€
12221	36	25	6,8	115,00

ohne Wasserbad
without water bath



Elektrischer Suppentopf

electric soup warmer
marmita de sopa eléctrica
marmite à soupe électrique



direkte Wärmeübertragung ohne Wasserbad, manuelle Temperaturregelung mit digitalem Anzeigenfenster, Temperatur einstellbar zwischen 60 ° C und 80 ° C, 1000 W / 230 V, herausnehmbarer Einsatz aus Edelstahl, Deckel mit hitzeisoliertem Griff und Löffelaussparung
direct heat transfer without bain marie, manual temperature control with digital display window, temperature adjustable between 60 ° C and 80 ° C, 1000 W / 230 V, removable stainless steel insert, lid with heat insulated handle and notched for spoon

traspaso térmico directo sin baño maría, control manual de la temperatura con ventana de visualización digital, temperatura ajustable entre 60 ° C y 80 ° C, 1000 W / 230 V, inserto de acero inoxidable extraíble, tapa con asas frías y con hueco para la cuchara

transfert direct de chaleur sans bain-marie, contrôle manuel de la température avec fenêtre d'affichage numérique, température réglable entre 60 ° C et 80 ° C, 1000 W / 230 V, insert en acier inoxydable amovible, couvercle avec poignée d'isolation thermique et avec espace pour la louche

	Ø cm	↑ cm	ltr.	€
11903	34,0	33,0	10	130,00

Speisenbehälter / foodpan / recipiente sopa / récipient à soupe

11906				36,00
-------	--	--	--	-------

Deckel / cover / tapa / couvercle

11907				15,00
-------	--	--	--	-------

hot price



Elektrischer Suppentopf „ECONOMIC“

electric soup warmer
marmita de sopa eléctrica
marmite à soupe électrique



Stahl schwarz lackiert, herausnehmbarer Einsatz aus Edelstahl, Temperaturregelung 30°C - 90°C, dreh- und klappbarer Edelstahl-Deckel, inkl. 8 magnetisch haftenden Beschriftungen, 400 W / 230 V

metal, black, removable soup pot, thermostat 30°C - 90°C, st. steel lid, incl. 8 magnetic signs, 400 W / 230 V

metal negro, recipiente sopa inox extraíble, termostato 30°C- 90°C, tapa inox, incluye 8 letreros magnéticos, 400 W / 230 V

acier, noir, récipient à soupe inox amovible, thermostat 30°C - 90°C, couvercle inox, 8 étiquettes magnétiques, 400 W / 230 V

	Ø cm	↑ cm	ltr.	€
11915	32	36	9	105,00

Speisenbehälter / foodpan / recipiente sopa / récipient à soupe

11916				23,00
-------	--	--	--	-------

Deckel / cover / tapa / couvercle

11917				14,90
-------	--	--	--	-------



11901

11902

Elektrischer Suppentopf

electric soup warmer
marmita de sopa eléctrica
marmite à soupe électrique



herausnehmbarer Einsatz aus Edelstahl, elektrisch, mit Wasserbad + Löffel + integrierter Tragering für den Innenbehälter, Deckel mit hitzeisolierendem Griff, Temperaturregelung 80°C (± 10°C), 450-550 W, 230 V

removable soup st. steel pan, bain marie electric, ladle, circular frame, thermostat control till 80°C (± 10°C), 450-550 W, 230 V

recipiente sopa inox extraíble, baño maria eléctrico + cucharón + aro inox, tapa con asas frías, termostato hasta 80°C precisión (± 10°C), 450-550 W, 230 V

réipient à soupe inox amovible, bain-marie électrique, louche, support circulaire inox, thermostat maxi 80°C (± 10°C), 450-550 W, 230 V

	Ø cm	↑ cm	ltr.	Farbe / Colour	€
11901	38	36,5	10	■	129,00
11902	38	36,5	10	■	129,00



Elektrischer Suppentopf

electric soup warmer
marmita de sopa eléctrica
marmite à soupe électrique



herausnehmbarer Einsatz aus Edelstahl, elektrisch, mit Wasserbad + Löffel + integrierter Tragering für den Innenbehälter, Deckel mit hitzeisolierendem Griff, Temperaturregelung 80°C (± 10°C), 400 - 450 W / 220 - 240 V

removable soup st. steel pan, bain marie electric, ladle, st. steel circular frame, thermostat control till 80°C (± 10°C), 400 - 450 W / 220 - 240 V

recipiente sopa inox extraíble, baño maria eléctrico + cucharón + aro inox, tapa con asas frías, termostato hasta 80°C precisión (± 10°C), 400 - 450 W / 220 - 240 V

réipient à soupe inox amovible, bain-marie électrique, louche, support circulaire inox, thermostat maxi 80°C (± 10°C), 400 - 450 W / 220 - 240 V

	Ø cm	↑ cm	ltr.	€
11910	40	37	10	129,00

Edelstahlgefäß / stainless steel pan / recipiente sopa inox / réipient à soupe inox

11911	50,00
-------	-------

Edelstahl-Deckel / stainless steel lid / tapa inox / couvercle inox

11912	31,00
-------	-------

Elektrokabel / electric cable / cable eléctrico / cable électrique

11913	14,00
-------	-------



Elektro-Suppenstation

soup warmer
chafing dish doble para sopa
chafing dish 2 soupieres



2 Suppentöpfe + 2 Suppenkellen + Deckelhalter, Thermostat (Überhitzungsschutz), 900 W, 230 V
2 soup pots + 2 soup ladles + lid holder, thermostat control 900 W, 230 V
incluye 2 ollas de sopa + 2 cucharones + bloqueo de la tapa, termostato 900 W, 230 V
2 marmites + 2 louches + blocage du couvercle + thermostat, 900 W, 230 V

	cm	↑ cm	ltr.	€
12228	65 x 35,5	31	2 x 4	215,00



Rolltophaube „SWISS“

rolltop-cover
campana rolltop
cloche rolltop



hochglanzpoliert, klappbar auf 90°, nachrüstbar für alle handelsüblichen Chafer
mirror polished finish, cover adjustable at 90°, usable for all commercial chafing dishes
pulido brillante, tapa ajustable 90°, apto para todos los chafings profesionales
poli brillant, ouverture réglable à 90°, apte pour tous les chafings professionnels

	cm	↑ cm	€
12310	55 x 34	19,5	89,00

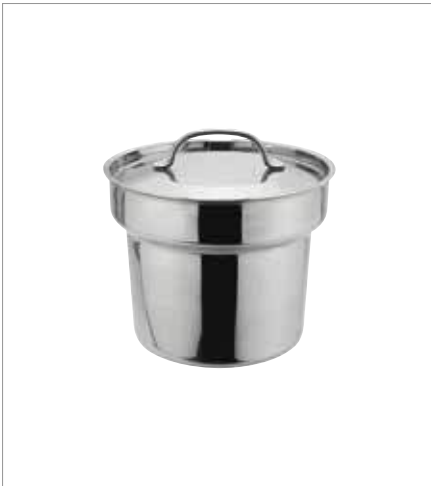

Bain-Marie Topf

bain marie pot
olla baño Maria
marmite bain-marie



inkl. Deckel, mit Löffelaussparung
included cover, notched for spoon
incluye tapa con hueco para la cuchara
inclut le couvercle avec espace pour la louche

	Ø cm	↑ cm	ltr.	€
12244	20	18	4,5	26,00

Deckel / cover / tapa / couvercle

	€
11244	7,50



Bain-Marie Deckel

cover for bain marie
tapa del baño maría
couvercle du bain-marie



	cm	€
12243	54 x 33,5	26,00



12 ltr.

Kaffeedispenser „ROYAL“

coffee dispenser
dispensador de café
distributeur de café



hochglanzpoliert, für warme Getränke, stabil und standfest, inkl. 1 Brennpastenbehälter
mirror polished finish, for warm drinks, solid and stable, incl. 1 burner holder
acabado brillante para bebidas calientes, sólido y estable, incluye un calentador
brillant, pour boissons chaudes, avec 1 brûleur, robuste et stable

	cm	↑ cm	ltr.	€
11667	28 x 28	65	12	256,00



10,5 ltr.

Kaffeedispenser „HAPPY HOUR“

coffee dispenser
dispensador de café
distributeur de café



hochglanzpoliert, für warme Getränke, stabil und standfest, inkl. 1 Brennpastenbehälter
mirror polished finish, for warm drinks, solid and stable, incl. 1 burner holder
acabado pulido brillante para bebidas calientes, sólido y estable, incluye un calentador
brillant, pour boissons chaudes, avec 1 brûleur, robuste et stable

	cm	↑ cm	ltr.	€
11672	31 x 33,5	54,5	10,5	190,00

Hahn / tap / grifo / robinet

	€
11671	25,00

Elektro-Heizelement / heating unit / resistencia / résistance

	cm	↑ cm	€
12287	21 x 20	6	98,00



Hot Plate „ECONOMIC“

hot plate
placa caliente
plaque chaude



automatische Temperaturregelung, die Alu-Heizplatte ist in ca. 5 Minuten auf ca. 75°C erhitzt und hält Speisen auf konstanter Temperatur

with automatic power supply, gets up to 75°C in 5 min., keeps food on continuous temperature control automático de temperatura, mantiene los alimentos en temperatura constante, la placa de aluminio llega a 75° C en aprox. 5 min.

contrôle automatique de température, maintient les aliments à température constante sur la plaque aluminium, montée à 75°C en 5 min. approx.

	cm	GN	€
11920	53 x 32,5	1/1	174,00



Einbau-Induktionskochplatte für Chafing Dish

built-in induction plate for chafing dish
placa de inducción para empotrar
plaque à induction à encastrer

inkl. Kabel-Fernbedienung, energiesparend, Leistung in 5 Stufen regelbar, integrierte Lüftung, sehr leise im Betrieb

incl. cable remote control, energy-saving, power adjustable in 5 steps, integrated ventilation, very quiet in operation

incl. mando a distancia con cable, ahorro energético, potencia regulable en 5 pasos, ventilación integrada, funcionamiento silencioso

y compris télécommande filaire, économe en énergie, puissance réglable en 5 étapes, ventilation intégrée, très silencieux en fonctionnement

	cm	↑ cm		€
12285	35,5 x 35,5	6	2000 W	199,00



Induktionskochplatte für Chafing Dish

induction plate for chafing dish
placa de inducción para chafing dish
plaque à induction pour chafing dish

mit Regler

with power control

con control de potencia

avec régulateur

	Ø cm		€
12295	24	900 W	129,00



Metallrahmen für Induktionskochplatten

frame for induction plate
marco para placa de inducción
cadre support inox pour plaque induction



		€
12291	für runde Chafer / for round chafing dish	17,00
12296	für Chafer GN 1/1 / for GN 1/1 chafing dish	18,00



Elektro-Heizelement

heating unit
resistencia
résistance



für mehrheitlich geöffnete Chafer GN 1/1 mit einstellbarem Leistungsregler
for GN 1/1 chafer covers are open most of the time, with adjustable control
para GN 1/1 chafing dish abiertos, con termostato
pour chafing dish GN 1/1 dont le couvercle reste souvent ouvert, avec thermostat

12294	800 W / 230 V	€ 162,00
-------	---------------	----------



Elektro-Heizelement

heating unit
resistencia
résistance



für mehrheitlich geöffnetem Chafing Dish GN 1/1
for GN 1/1 chafer covers open most of the time
para chafing dish GN 1/1 con la tapa casi siempre abierta
pur chafing dish GN 1/1 dont le couvercle reste souvent ouvert

12292	600 W / 230 V	€ 120,00
-------	---------------	----------



Elektro-Heizelement

heating unit
resistencia
résistance



für mehrheitlich geschlossene Chafer GN 1/1
for GN 1/1 chafer covers are closed most of the time
para chafing dish GN 1/1 casi siempre cerrados
pour chafing dish GN 1/1 qui restent habituellement fermés

12290	360 W / 140 - 250 V	€ 116,00
-------	---------------------	----------



Elektro-Heizelement

heating unit
resistencia
résistance



für Kaffeedispenser (Nr. 11672), 500 W, 220 V, einfach in das Gestell des Dispensers legen
for coffee dispenser (no. 11672), 500 W, 220 V, insert into the frame of the dispenser
para dispensador de café (11672), 500 W, 220V, directamente en el pie del dispensador
pour distributeur à café (11672), 500 W, 220 V, directement dans le support

12287	500 W / 220 V	€ 98,00
-------	---------------	---------



Mobile Chafing Dish Heizung

heating element
resistencia
résistance



für alle marktgängigen Chafing Dishes
suitable for all current popular chafing dishes, with special spring
para todos los chafing dish más corrientes
pour la plupart des chafing dish les plus courants

12299	Ø cm	↑ cm	500 W / 220 V	€
	14	9 - 11		81,00



Heizplatte durch Spiralfeder an Wasserbad gedrückt
Heizplatte durch Spiralfeder an Wasserbad gedrückt

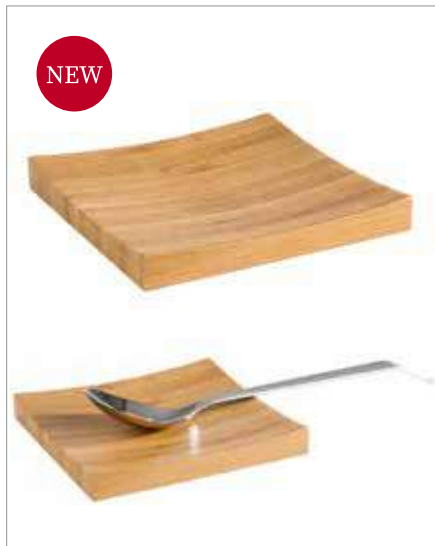

Besteckablage „WOOD“, 2er Set
 cutlery rest, 2 pcs.
 reposa cuchara, set de 2
 pose-cuillère, set de 2



	cm	↑ cm	pcs.	€
00655	13 x 13	2	2	9,00



Holz Bambus, mit Antirutschfüßchen
 wood bamboo, with non-slip feet
 madera bambú, con pies antideslizantes
 bois de bambou, avec pieds antidérapants



Besteckablage
 cutlery rest
 reposa cuchara
 pose-cuillère



	cm	↑ cm	€
00650	27 x 11	3,5	8,00



Besteckablage „SPOON“
 cutlery rest
 reposa cuchara
 pose-cuillère



	cm	↑ cm	€
83801	26 x 10,5	5	6,00



Besteckablage „BOWL“
 cutlery rest
 reposa cuchara
 pose-cuillère



	cm	↑ cm	ltr.	€
83803	22,5 x 11	6	0,5	6,40



Besteckablage „SMALL WAVE“
 cutlery rest
 reposa cuchara
 pose-cuillère



	cm	↑ cm	€
83897	26 x 13	4,5	8,90



Brennpastenbehälter

burner holder
quemador
brûleur

mit Bajonettverschluss

bayonet lock
cierre de bayoneta
verrouillage par baïonnette



	Ø cm	↑ cm	€
11683	9	6	6,00



Flasche Brennflüssigkeit „HOT & SAFE“

bottle fuel
botella de combustible líquido
bouteille de combustible liquide



	ltr.	fits to	€
00208	1	00100	5,80



Wärme-Kies

granite chips
granulado térmico
gravier thermique

für Chafing Dishes, feine Körnung, hohe Wärmespeicherung, kein Verkleben, ideal zum Warmhalten von Eiern

fine for chafing dishes and clean granite chippings, ideal for keeping eggs warm
gravilla de granito fina limpia, ideal para mantener los huevos calientes
gravier fin de granit, lavé, idéal pour maintenir les oeufs au chaud



	kg	€
81116	7	19,00



Backhandschuhe

baking mittens
manoplas de panadero
gants de boulanger

Leder, gefüttert, Einheitsgröße, mit Stulpen, extrem hitzebeständig bis 250°C

leather, inner lining, one size, with cuffs, extremely heat resistant up to 250°C

cuero interior forrado, talla única, resiste a temperaturas hasta 250°C

cuir intérieur doublé, taille unique, résiste à maxi 250°C

	→ cm	€
88090	45	29,00

Chafing Dish, GN Container & Transport

GN-Behälter Größen nach EN 631

Alle Behälter sind aus rostfreiem Chrom-Nickel-Edelstahl mit elektrolytisch polierter (seidenmatt) Oberfläche und somit perfekt geeignet für den professionellen Einsatz.

GN-container according to EN 631

All pans are made of chrome/nickel stainless steel with a surface polished by electrolysis (satin-matt) and therefore highly suitable for professional operation.

De conformidad con la norma europea EN 631.

Todos los contenedores están fabricados en acero inoxidable cromado/niquelado con su superficie (satinada) pulida por electrolisis lo que la hace altamente apropiado para el uso profesional.

Bacs GN- Conforme à la norme EN 631

Tous les bacs sont fabriqués en inox/chrome/nickel, surface polie électrolythique (satiné). Approprié pour usage professionnel.

Vorteile der rund geprägten U-Ecken:

- erhöhte Stabilität durch verstärktes Profil
- zielgerechtes und sauberes Ausgießen
- genaue Positionierung der GN-Behälter
- superleichtes Stapeln und Entstapeln
- kein Verklemmen der GN-Behälter
- hohe Stoßfestigkeit durch robuste Konstruktion
- ansprechendes Design und stilvoller Blickfang

Advantages of the round-shaped U-Corners:

- increased stability due to the unique construction
- clean ladling and pouring
- exact positioning of the containers
- improved shock-resistance
- appealing design
- no seize of the containers

Ventajas de las esquinas en U:

Perfil reforzado que confiere mayor rigidez y resistencia a la cubeta, diseño para verter fácil y limpiamente, fáciles de apilar y desapilar sin que se claven entre sí, construcción más robusta y resistente a los golpes mecánicos, diseño elegante.

Avantages et fonctionnalité des angles en U:

Profil renforcé pour une meilleure consistance et rigidité du récipient, design qui facilite un versage propre et aisé, permet un empilage et déempilage faciles sans que les bacs restent coincés, meilleure résistance aux chocs mécaniques, seign élégant.

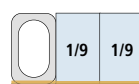
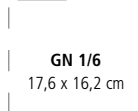
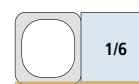
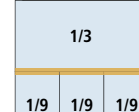
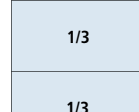
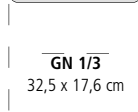
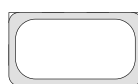
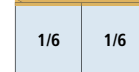
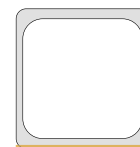
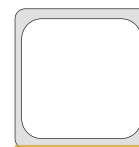
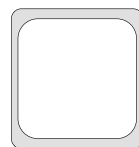
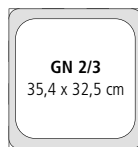
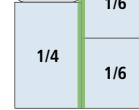
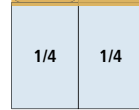
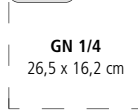
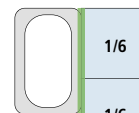
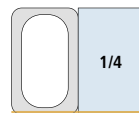
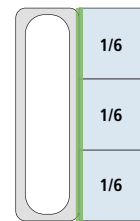
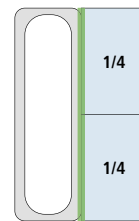
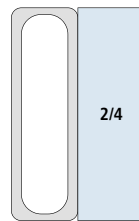
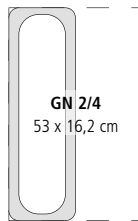
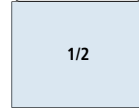
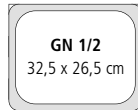
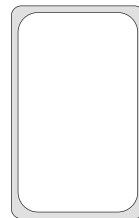



GN-Behälter

GN-container
GN cubetas
GN bacs



	GN	↓ mm	ltr.	cm	€
81000	2/1	20	5,0	53,0 x 65,0	33,10
81095	1/1	10	1,25	53,0 x 32,5	11,90
81100	1/1	20	2,5	53,0 x 32,5	13,30
81101	1/1	40	5,0	53,0 x 32,5	15,00
81109	1/1	55	6,5	53,0 x 32,5	15,60
81102	1/1	65	9,0	53,0 x 32,5	15,85
81104	1/1	100	13,25	53,0 x 32,5	19,60
81106	1/1	150	20,0	53,0 x 32,5	29,50
81108	1/1	200	28,0	53,0 x 32,5	35,65
81200	1/2	20	1,0	32,5 x 26,5	5,40
81201	1/2	40	2,0	32,5 x 26,5	8,15
81209	1/2	55	2,8	32,5 x 26,5	8,40
81202	1/2	65	4,0	32,5 x 26,5	8,65
81204	1/2	100	6,0	32,5 x 26,5	11,75
81206	1/2	150	8,75	32,5 x 26,5	18,50
81208	1/2	200	11,65	32,5 x 26,5	23,90
81300	1/3	20	0,75	32,5 x 17,6	4,20
81302	1/3	65	2,5	32,5 x 17,6	6,60
81304	1/3	100	4,0	32,5 x 17,6	9,25
81306	1/3	150	5,7	32,5 x 17,6	12,60
81308	1/3	200	7,0	32,5 x 17,6	16,70
81400	1/4	20	0,5	26,5 x 16,2	4,40
81401	1/4	40	1,0	26,5 x 16,2	5,00
81402	1/4	65	1,8	26,5 x 16,2	6,00
81404	1/4	100	2,8	26,5 x 16,2	7,90
81406	1/4	150	4,0	26,5 x 16,2	12,10
81408	1/4	200	5,5	26,5 x 16,2	15,10
81602	1/6	65	1,0	17,6 x 16,2	4,30
81604	1/6	100	1,6	17,6 x 16,2	6,00
81606	1/6	150	2,4	17,6 x 16,2	9,60
81608	1/6	200	3,0	17,6 x 16,2	11,90
81502	1/9	65	0,6	17,6 x 10,8	3,10
81504	1/9	100	1,0	17,6 x 10,8	4,80
81506	1/9	150	1,5	17,6 x 10,8	6,85
81700	2/3	20	1,5	35,4 x 32,5	9,50
81701	2/3	40	3,0	35,4 x 32,5	12,60
81702	2/3	65	5,5	35,4 x 32,5	14,60
81704	2/3	100	8,4	35,4 x 32,5	19,20
81706	2/3	150	12,5	35,4 x 32,5	27,85
81707	2/3	200	18,0	35,4 x 32,5	30,00
81800	2/4	20	1,2	53,0 x 16,2	8,00
81801	2/4	40	2,4	53,0 x 16,2	10,50
81802	2/4	65	3,6	53,0 x 16,2	12,25
81804	2/4	100	5,6	53,0 x 16,2	17,15
81806	2/4	150	8,7	53,0 x 16,2	20,00



perforierte GN-Behälter

perforated GN-container
cubetas GN perforadas
bacs GN perforés



	GN	↓ mm	cm	€
81911	1/1	40	53,0 x 32,5	15,60
81907	1/1	65	53,0 x 32,5	15,85
81908	1/1	100	53,0 x 32,5	19,60
81909	1/1	150	53,0 x 32,5	29,50
81910	1/1	200	53,0 x 32,5	35,65
81901	1/2	65	32,5 x 26,5	8,65
81902	1/2	100	32,5 x 26,5	11,75
81903	1/2	150	32,5 x 26,5	18,50
81904	1/2	200	32,5 x 26,5	23,90
81905	2/3	65	35,4 x 32,5	14,60
81906	2/3	100	35,4 x 32,5	19,20



GN-Deckel

GN-lid
GN tapa
GN couvercle



ohne Löffelaussparung
without notched edge for spoons
sin agujero para cucharón
sans espace pour louche

	GN	cm	€
81195	1/1	53,0 x 32,5	12,25
81295	1/2	32,5 x 26,5	6,25
81395	1/3	32,5 x 17,6	4,70
81495	1/4	26,5 x 16,2	4,45
81695	1/6	17,6 x 16,2	2,50
81591	1/9	17,6 x 10,8	2,65
81795	2/3	35,4 x 32,5	13,50
81895	2/4	53,0 x 16,2	9,70



GN-Deckel

GN-lid
GN tapa
GN couvercle



mit Löffelaussparung
with notched edge for spoons
con agujero para cucharón
avec espace pour louche

	GN	cm	€
81191	1/1	53,0 x 32,5	13,30
81292	1/2	32,5 x 26,5	7,00
81391	1/3	32,5 x 17,6	5,30
81492	1/4	26,5 x 16,2	5,00
81692	1/6	17,6 x 16,2	2,95
81595	1/9	17,6 x 10,8	2,80
81791	2/3	35,4 x 32,5	14,60
81891	2/4	53,0 x 16,2	10,80



mit Löffelaussparung
with notched edge for spoons



Adapter / Zwischensteg

adapter
adaptador
adaptateur



ermöglicht stabilen Halt von GN-Behältern im CD, rostfreier Chrom-Nickel-Edelstahl

for fixing GN pans, chrome / nickel stainless steel

para sujetar las cubetas GN, acero inox

support stable pour les bacs GN

	cm		€
81997	17,6	längs bei GN 1/9 / lengthwise GN 1/9 longitud GN 1/9 / GN 1/9 dans la longueur	1,40
81999	32,5	quer bei GN 1/2 / crosswise GN 1/2 de ancho GN 1/2 / GN 1/2 dans la largeur	2,65
81998	53	längs bei GN 1/1 / lengthwise GN 1/1 longitud GN 1/1 / GN 1/1 dans la longueur	4,70



schwappsicherer Deckel

GN Transport-Steck-Deckel

GN-lid with silicone seal

GN tapa hermética con junta

GN couvercle hermétique avec joint



Silikondichtung, Griffmulde und Loch gegen Unterdruck,
nicht für Kombidämpfer geeignet

silicone joint, flat handle, vent to compensate
for pressure, not usable for steam oven

junta de silicona, asa empotrada, válvula para compensar
la presión, no se puede utilizar en hornos de vapor

joint silicone, anse encastrée, valve pour compenser la pression

	GN	cm	€
80023	1/1	53,0 x 32,5	29,00
80024	1/2	32,5 x 26,5	18,00
80025	1/3	32,5 x 17,6	15,70
80026	1/4	26,5 x 16,2	13,50
80027	1/6	17,6 x 16,2	11,00
80028 <small>NEW</small>	2/4	53,0 x 16,2	26,00
80029 <small>NEW</small>	2/3	35,4 x 32,5	28,00



GN Abtropfgitter

GN-drainer

GN escurridor

GN égouttoir



Abtropfgitter aus Edelstahl für Gastronorm Behälter, passend für GN 1/1 und GN 1/2

stainless steel GN drainer for GN 1/1 + GN 1/2

escurridor GN de acero inoxidable para GN 1/1 + GN 1/2

égouttoir GN en acier inoxydable pour GN 1/1 + GN 1/2

	GN	cm	↑ cm	€
81117	1/1	45 x 25	1,5	18,00
81118	1/2	25 x 19	1,5	13,00



GN-Behälter aus Polycarbonat

GN-container polycarbonate
GN cubeta policarbonato
GN bac polycarbonate

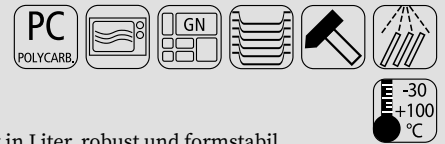

transparent: Inhalt gut erkennbar, Skalierung in Liter, robust und formstabil

transparent: content can be seen, liter scale, solid quality

transparente para ver el contenido, graduación en litros, alta calidad

transparent pour voir le contenu, graduation en litres, haute-qualité

	GN	↓ mm	ltr.	cm	€
82004	1/1	65	8,5	53,0 x 32,5	13,40
82006	1/1	100	13,0	53,0 x 32,5	15,40
82008	1/1	150	19,5	53,0 x 32,5	19,00
82010	1/1	200	26,0	53,0 x 32,5	25,00
	GN	↓ mm	ltr.	cm	€
82012	1/2	65	3,9	32,5 x 26,5	6,40
82014	1/2	100	5,9	32,5 x 26,5	7,80
82016	1/2	150	8,9	32,5 x 26,5	9,60
82017	1/2	200	11,8	32,5 x 26,5	13,00
	GN	↓ mm	ltr.	cm	€
82018	1/3	65	2,4	32,5 x 17,6	5,40
82020	1/3	100	3,6	32,5 x 17,6	6,40
82022	1/3	150	5,3	32,5 x 17,6	7,80
82023	1/3	200	7,0	32,5 x 17,6	9,60
	GN	↓ mm	ltr.	cm	€
82028	1/4	65	1,7	26,5 x 16,2	4,20
82030	1/4	100	2,5	26,5 x 16,2	5,00
82032	1/4	150	3,7	26,5 x 16,2	8,00
82034	1/4	200	4,8	26,5 x 16,2	9,90
	GN	↓ mm	ltr.	cm	€
82036	1/6	65	1,0	17,6 x 16,2	3,60
82038	1/6	100	1,5	17,6 x 16,2	3,90
82040	1/6	150	2,2	17,6 x 16,2	4,80
82042	1/6	200	2,8	17,6 x 16,2	6,80
	GN	↓ mm	ltr.	cm	€
82050	1/9	65	0,6	17,6 x 10,2	2,60
82051	1/9	100	1,0	17,6 x 10,2	3,00



GN-Deckel

GN-lid
GN tapa
GN couvercle



	GN	cm	€
82001	1/1	53,0 x 32,5	9,00
82013	1/2	32,5 x 26,5	5,00
82019	1/3	32,5 x 17,6	4,00
82029	1/4	26,5 x 16,2	3,20
82037	1/6	17,6 x 16,2	2,50
82059	1/9	17,6 x 10,8	2,20



GN Abtropfgitter

GN drainer
GN escurridor
GN égouttoir



	GN	cm	€
82003	1/1	53,0 x 32,5	6,60
82005	1/2	32,5 x 26,5	3,60
82007	1/3	32,5 x 17,6	2,90



GN-Behälter aus Polypropylen

GN-container polypropylene
GN cubetas polipropileno
GN bacs polypropilène



milchig (nicht transparent), Skalierung in Liter, robust und formstabil

frosted, Liter scale, solid quality

translúcido opaco, graduación en litros, muy resistente a la deformación, robusto

translucide opaque, graduation en litres, très résistant à la déformation, robuste

	GN	↓ mm	ltr.	cm	€
82104	1/1	65	8,5	53,0 x 32,5	7,60
82106	1/1	100	13,0	53,0 x 32,5	8,80
82108	1/1	150	19,5	53,0 x 32,5	10,00
82110	1/1	200	26,0	53,0 x 32,5	12,50

	GN	↓ mm	ltr.	cm	€
82112	1/2	65	3,9	32,5 x 26,5	4,10
82114	1/2	100	5,9	32,5 x 26,5	4,80
82116	1/2	150	8,9	32,5 x 26,5	5,80
82117	1/2	200	11,8	32,5 x 26,5	6,80

	GN	↓ mm	ltr.	cm	€
82118	1/3	65	2,4	32,5 x 17,5	3,40
82120	1/3	100	3,6	32,5 x 17,5	4,00
82122	1/3	150	5,3	32,5 x 17,6	5,20
82123	1/3	200	7,0	32,5 x 17,6	6,00

	GN	↓ mm	ltr.	cm	€
82128	1/4	65	1,7	26,5 x 16,2	2,90
82130	1/4	100	2,5	26,5 x 16,2	3,20
82132	1/4	150	3,7	26,5 x 16,2	4,40
82134	1/4	200	4,8	26,5 x 16,2	6,90

	GN	↓ mm	ltr.	cm	€
82136	1/6	65	1,0	17,6 x 16,2	2,40
82138	1/6	100	1,5	17,6 x 16,2	2,80
82140	1/6	150	2,2	17,6 x 16,2	3,20
82142	1/6	200	2,8	17,6 x 16,2	5,80

	GN	↓ mm	ltr.	cm	€
82150	1/9	65	0,6	17,6 x 10,8	2,20
82151	1/9	100	1,0	17,6 x 10,8	2,40



stapelbar
stackable



GN-Deckel

GN-lid
GN tapa
GN couvercle



	GN	cm	€
82101	1/1	53,0 x 32,5	4,30
82113	1/2	32,5 x 26,5	2,50
82119	1/3	32,5 x 17,6	2,10
82129	1/4	26,5 x 16,2	2,00
82137	1/6	17,6 x 16,2	1,90
82159	1/9	17,6 x 10,8	1,80

Chafing Dish, GN Container & Transport



GN-Konvektomatenblech

GN-convection oven trays
GN cubeta para hornos de convección
GN bac pour fours à convection



Oberfläche mit schwarzer Antihafbeschichtung, schwere Qualität

coated black non stick, heavy quality
interior con revestimiento antiadherente negro, alta calidad
revêtement intérieur antiadhérent noir, haute qualité

	GN	↓ mm	cm	€
88246	1/1	20	53,0 x 32,5	36,60



GN-Konvektomatenblech - Emailliert

GN-convection oven trays enamelled
GN cubeta esmaltada para hornos de convección
GN bac émaillé pour fours à convection



beidseitig beschichtet mit schwarzer Granit-Emaille, gelochte Ecken, schwere Qualität

both sides coated with black granite enamel, perforated rim corners, heavy gauge
chapa de hierro esmaltada por ambas caras, color granito negro, borde con ángulos perforados, alta calidad
plaque acier émaillé intérieur et extérieur, granité noir, bord perforé dans les angles, qualité renforcée

	GN	↓ mm	cm	€
88244	1/1	20	53 x 32,5	23,80
88144	1/1	40	53 x 32,5	26,50
88245	1/1	65	53 x 32,5	28,60



Backblech

baking sheet
bandeja pastelera
plaque à pâtisserie



gelocht Ø 3 mm, Materialstärke 1,5 mm, Silikon beschichtet, temperaturbeständig bis 240°C

perforated Ø 3 mm, coated with silicon, heat resistant up to 240°C
aluminio con revestimiento de silicona perforada, resistente hasta 240°
aluminium avec revêtement silicone, perforée, température maxi 240°

	GN	cm	€
88285	1/1	53 x 32,5	29,80



GN Roste

GN grid
GN rejilla
GN grille



elektrolytisch poliert, Drahtstärke 3 mm, Rahmendraht 6 mm, extra schwere Qualität

electro-polished, wire thickness 3 mm, frame wire 6 mm, extra heavy quality
inox pulido electrolítico, grosor alambre 3 mm, grosor marco 6 mm, calidad reforzada
inox poli électrolytique, fil 3 mm, cadre 6 mm, qualité renforcée

	GN	cm	€
81199	2/1	65,0 x 53,0	41,00
81198	1/1	53,0 x 32,5	18,90
81796	2/3	32,5 x 35,4	12,50
81296	1/2	32,5 x 26,5	10,00



GN 1/3 Bestecksammler

GN 1/3 container
GN 1/3 cubeta
GN 1/3 bac



mit 2 Haken zum Einhängen an Servier- oder Transportwagen

container with 2 hooks, to hang on trolleys for cutlery
cubeta con 2 ganchos para cubiertos, a colgar del carro
bac à couverts avec 2 crochets, à accrocher au chariot

	GN	↓ mm	cm	€
11978	1/3	150	32,5 x 17,5	18,00



GN-Behälter

GN-container
GN cubetas
GN bac



	GN	↓ mm	ltr.	cm	€
82100	1/1	60	7,1	53,0 x 32,5	48,00
82200	1/2	60	3,4	32,5 x 26,5	22,00
82300	1/3	60	2,0	32,5 x 17,6	17,00
82306	2/3	60	4,6	35,4 x 32,5	32,90
82301	2/4	60	3,0	53,0 x 16,2	30,00



GN Tablett „FRAMES“

GN tray
GN bandeja
GN plateau



	GN	↑ cm	cm	€
82355	1/1	2	53,0 x 32,5	33,00
82356	1/2	2	32,5 x 26,5	19,00
82357	1/3	2	32,5 x 17,6	16,00



GN Tablett

GN tray
GN bandeja
GN plateau

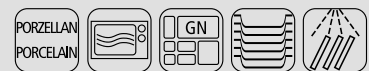

	GN	↑ cm	cm	€
82201	1/1	2,5	53,0 x 32,5	33,00
82202	1/2	2,5	32,5 x 26,5	19,00
82203	1/3	2,5	32,5 x 17,6	16,00
82204	2/4	2,5	53,0 x 16,2	26,00
82205	2/3	2,5	35,4 x 32,5	28,00



GN Servier- / Buffetplatte

GN dish
GN bandeja bufé
GN plat buffet



	GN	↑ cm	cm	€
83301	1/1	2	53,0 x 32,5	42,00
83305	1/2	2	32,5 x 26,5	25,80
83304	1/3	2	32,5 x 17,5	16,00
83303	2/4	2	53,0 x 16,2	29,00

Chafing Dish, GN Container & Transport

hot price



GN 2/4



GN 1/1



GN 1/2



GN 1/4



GN 1/6

GN-Behälter „ECOLINE“

GN container

GN cubeta

GN bac



mit Stapelnocke

with notching edge

con borde marcado para el apilado

avec rebord pour l'empilage

	GN	↓ mm	ltr.	cm	Farbe / Colour	€
83759	1/1	65	7,10	53,0 x 32,5		28,00
83755	2/4	65	3,00	53,0 x 16,2		19,00
83757	1/2	65	3,40	32,5 x 26,5		15,80
83753	1/3	65	2,00	32,5 x 17,6		13,80
83751	1/4	65	1,35	26,5 x 16,2		12,50
83749	1/6	65	0,80	17,6 x 16,2		10,00

	GN	↓ mm	ltr.	cm	Farbe / Colour	€
83758	1/1	65	7,10	53,0 x 32,5		28,00
83754	2/4	65	3,00	53,0 x 16,2		19,00
83756	1/2	65	3,40	32,5 x 26,5		15,80
83752	1/3	65	2,00	32,5 x 17,6		13,80
83750	1/4	65	1,35	26,5 x 16,2		12,50
83748	1/6	65	0,80	17,6 x 16,2		10,00

	GN	↓ mm	ltr.	cm	Farbe / Colour	€
84300	1/1	100	10,6	53,0 x 32,5		33,00
84302	2/4	100	4,3	53,0 x 16,2		24,00
84301	1/2	100	4,7	32,5 x 26,5		19,50
84303	1/3	100	2,7	32,5 x 17,6		15,50
84304	1/4	100	1,9	26,5 x 16,2		14,00
84305	1/6	100	1,0	17,6 x 16,2		10,50

	GN	↓ mm	ltr.	cm	Farbe / Colour	€
84306	1/1	100	10,6	53,0 x 32,5		33,00
84308	2/4	100	4,3	53,0 x 16,2		24,00
84307	1/2	100	4,7	32,5 x 26,5		19,50
84309	1/3	100	2,7	32,5 x 17,6		15,50
84310	1/4	100	1,9	26,5 x 16,2		14,00
84311	1/6	100	1,0	17,6 x 16,2		10,50

GN-Deckel

GN-lid

GN tapa

GN couvercle



	GN	cm	€
82001	1/1	53,0 x 32,5	9,00
82013	1/2	32,5 x 26,5	5,00
82019	1/3	32,5 x 17,6	4,00
82029	1/4	26,5 x 16,2	3,20
82037	1/6	17,6 x 16,2	2,50



GN-Behälter „HIGHLINE“

GN-container
GN cubeta
GN bac



extrem bruchsicher, glänzende und harte Oberfläche, tiefkühlfest, keinen Temperaturschocks unterziehen, nicht auf heißen Flächen liegen lassen, mit Stapelnocke

durable, top quality, hard and glossy surface, avoid thermal shocks, do not leave on hot surfaces, with notching edge

duradera, alta calidad, superficie brillante y resistente, hay que evitar los cambios térmicos bruscos, no apoyar en superficies calientes, con borde para apilamiento

durable, haute qualité, surface brillante et résistante, éviter les chocs thermiques et ne pas poser sur une surface chaude, encoche pour une louche

	GN	↓ mm	ltr.	cm	€
83772	1/1	65	7,10	53,0 x 32,5	36,00
83770	2/3	65	4,60	35,0 x 32,5	32,50
83768	1/2	65	3,40	32,5 x 26,5	20,00
83766	2/4	65	3,00	53,0 x 16,2	23,50
83764	1/3	65	2,00	32,5 x 17,6	15,50
83762	1/4	65	1,35	26,5 x 16,2	14,50
83760	1/6	65	0,80	17,6 x 16,2	11,00

	GN	↓ mm	ltr.	cm	€
83773	1/1	100	11,0	53,0 x 32,5	41,00
83769	1/2	100	5,50	32,5 x 26,5	23,40
83765	1/3	100	3,15	32,5 x 17,6	18,00
83763	1/4	100	2,20	26,5 x 16,2	16,00
83761	1/6	100	1,25	17,6 x 16,2	12,40



„SYSTEM-THEKE“

system-counter
Sistema para mostrador
Système-Comptoir



	cm	↑ cm	ltr.	Farbe / Colour	€
84050	22 x 14,5	2		White	4,40
84053	22 x 14,5	9	1,7	White	8,80
84059	29 x 22,0	4	1,3	White	10,00
84062	29 x 29,0	2		White	9,40
84066	44 x 22,0	2		White	12,50
84069	44 x 29,0	2		White	15,50

	cm	↑ cm	ltr.	Farbe / Colour	€
84150	22 x 14,5	2		Black	4,40
84153	22 x 14,5	9	1,7	Black	8,80
84159	29 x 22,0	4	1,3	Black	10,00
84162	29 x 29,0	2		Black	9,40
84166	44 x 22,0	2		Black	12,50
84169	44 x 29,0	2		Black	15,50



Deckel „SYSTEM-THEKE“, mit Löffelaussparung

cover, with notched for spoons
tapa, con espacio para la cuchara
couverture avec encoche pour la cuillère



	cm	€
84054	22 x 14,5	6,50
84061	29 x 22,0	9,50
84065	29 x 29,0	12,50
84068	44 x 22,0	13,50

STOP-TOOLS

Die STOP-Funktion verhindert, dass Gabel oder Löffel in das Gefäß rutschen.

The smart STOP-function prevent forks and spoon not to slip into the vessel.

La función STOP evita que los cubiertos se caigan dentro del recipiente. Antideslizante.

La fonction STOP empêche les couverts de glisser dans le récipient.



STOP
Funktion



Servierlöffel

serving spoon
cuchara de servicio
cuillère de service



Materialdicke 2,5 mm, ergonomischer, rutschfester Griff
ergonomic antislip handle
mango ergonómico antideslizante
manche ergonomique antidérapante

	cm	→ cm	€
00834	10 x 7,5	Griff / handle 17	9,90



Servierlöffel geschlitzt

slotted spoon
cuchara de servicio
cuillère de service



Materialdicke 2,5 mm, ergonomischer, rutschfester Griff
ergonomic antislip handle
mango ergonómico antideslizante
manche ergonomique antidérapante

	cm	→ cm	€
00833	10 x 7,5	Griff / handle 17	9,90



Schöpflöffel

ladle
cucharón
louche



Materialdicke 2,5 mm, ergonomischer, rutschfester Griff
ergonomic antislip handle
mango ergonómico antideslizante
manche ergonomique antidérapante

	Ø cm	→ cm	litr.	€
00832	9	Griff / handle 17	0,08	10,40



Fleischgabel

meat fork
tenedor de carne
fourchette à viande



Materialdicke 2,5 mm, ergonomischer, rutschfester Griff
ergonomic antislip handle
mango ergonómico antideslizante
manche ergonomique antidérapante

	cm	→ cm	€
00831	10,5 x 4	Griff / handle 17	9,90



Servierlöffel

serving spoon
cuchara de servicio
cuillère de service



ergonomischer, rutschfester Griff
ergonomic antislip handle
mango ergonómico antideslizante
manche ergonomique antidérapante

	cm	→ cm		€
00662	11 x 7	Griff / handle 25		6,00



Servierlöffel geschlitzt

serving spoon
cuchara de servicio
cuillère de service



ergonomischer, rutschfester Griff
ergonomic antislip handle
mango ergonómico antideslizante
manche ergonomique antidérapante

	cm	→ cm		€
00664	11 x 7	Griff / handle 25		6,00



Wender

turner
espátula
spatule



ergonomischer, rutschfester Griff
ergonomic antislip handle
mango ergonómico antideslizante
manche ergonomique antidérapante

	cm	→ cm		€
00668	10 x 8	Griff / handle 25		6,60



Schöpflöffel

ladle
cucharón
louche



ergonomischer, rutschfester Griff
ergonomic antislip handle
mango ergonómico antideslizante
manche ergonomique antidérapante

	cm	→ cm	ltr.	€
00670	9 x 8	Griff / handle 25	0,15	6,60



Fleischgabel

meat fork
tenedor de carne
fourchette à viande



ergonomischer, rutschfester Griff
ergonomic antislip handle
mango ergonómico antideslizante
manche ergonomique antidérapante

	cm	→ cm		€
00666	10 x 3,5	Griff / handle 25		6,00



Schöpflöffel „PROFI“

ladle
cacillo
louche



	∅ cm	→ cm	ltr.	€
00710	5	Griff / handle 27	0,030	10,80
00711	6	Griff / handle 28	0,050	11,40
00712	7	Griff / handle 30	0,080	11,80
00713	8	Griff / handle 32	0,125	12,80
00714	9	Griff / handle 33	0,150	14,60
00715	10	Griff / handle 35	0,250	15,40
00716	11	Griff / handle 36	0,300	16,00
00717	14,5	Griff / handle 38	0,550	16,90



Schaumlöffel „PROFI“

skimmer
espumadera
écumoire



	∅ cm	→ cm	€
00720	8	Griff / handle 32	11,20
00721	10	Griff / handle 34	12,40
00722	12	Griff / handle 37	13,30
00723	14	Griff / handle 40	14,40



Wender „PROFI“

turner
espátula
spatule



	cm	→ cm	€
00730	10 x 11,5	Griff / handle 38	14,40



Servierlöffel „PROFI“

serving spoon
cuchara de servicio
cuillère de service



	cm	→ cm	€
00671	11 x 7	Griff / handle 29 geschlitzt / slotted	8,60
00672	11 x 7	Griff / handle 29	8,60



Spaghettilöffel „PROFI“

spaghetti spoon
cuchara de espaguetis
cuillère à spaghettis



	cm	→ cm	€
00673	10 x 7	Griff / handle 29	9,30



Salat- / Servierlöffel „BANQUET“

salad spoon / serving spoon
cuchara para ensalade / cuchara de servicio
cuillère à salade / cuillère de service



	cm	→ cm	€
00588	6,0 x 5	Griff / handle 17	4,50
00590	7,5 x 6	Griff / handle 21	6,80

Salatgabel „BANQUET“

salad fork
tenedor de servicio para ensalada
fourchette de service pour la salade



	cm	→ cm	€
00589	6,0 x 5	Griff / handle 17	4,50
00591	7,5 x 6	Griff / handle 21	6,80

Chafing Dish Löffel „BANQUET“

serving spoon
cuchara para servir
cuiller de service



	cm	→ cm	€
00592	11 x 6,5	Griff / handle 24	7,50
00593	11 x 6,5	Griff / handle 24 geschlitzt / slotted	7,50

Dressinglöffel „BANQUET“

dressing spoon
cuchara de aliño
cuillère à vinaigrette



	cm	→ cm	€
00594	6 x 4	Griff / handle 30	9,90

Schöpflöffel „BANQUET“

ladle
cucharón
louche



	cm	→ cm	€
00595	8,5 x 7,5	Griff / handle 24	12,90

Fleischgabel „BANQUET“

meat fork
tenedor de carne
fourchette à viande



	cm	→ cm	€
00596	8 x 2,5	Griff / handle 13	3,90

Serviergabel „BANQUET“

fork
tenedor de servicio
fourchette de service



	cm	→ cm	€
00597	9 x 4	Griff / handle 21	6,80

Pfannenwender „BANQUET“

turner
espatula
spatule



	cm	→ cm	€
00587 <small>NEW</small>	10 x 7,5	Griff / handle 21	7,90



Servier- / Transportwagen

serving trolley
carro de servicio
chariot de service



Gestell aus Vierkantröhr 25 x 25 mm, Ablagefläche innen 84 x 44,5 cm, Bodenfläche 90 x 50 cm, auf Unterseite schalldämmend beschichtet, Abstand zwischen den Böden 28 cm / 29 cm, mit 4 Lenkrollen Ø 12,5 cm, alle mit Feststellern, Lieferung demontiert, einfache Montage, Tragfähigkeit 33 kg je Boden

frame rectangular bar 25 x 25 mm, shelf board inside 84 x 44,5 cm, shelf board outside 90 x 50 cm, undersurface coated sound-damping, distance between the boards 28 cm / 29 cm, with 4 swivel wheels Ø 12,5 cm, all with brakes, unassembled, simple assembly, max load 33 kg per shelf

estructura tubo cuadrado 25 x 25 mm, útiles int. por piso 84 x 44,5 cm. ext. al suelo 90 x 50 cm revestimiento para absorber ruidos distancia entre pisos 28 cm / 29 cm, 4 ruedas giratorias 12,5 cm, con frenos, se sirve desmontado, montaje fácil, carga máx. 33 kg por piso

structure en tube carré 25x25 mm, 3 niveaux dimensions utiles 84x44,5 cm, encombrement au sol 90x50 cm, avec revêtement en partie inférieure pour absorber le bruit, distance entre niveaux 28 cm / 29 cm, 4 roues pivotantes 12,5 cm, avec frein, livré démonté, montage aisé, max. 33 kg de charge par niveau

	cm	↑ cm	€
71440	96 x 50	94	172,00



Servier- / Transportwagen

service trolley
carro de servicio
chariot de service



mit 3 Borden, Bordmaße ca. 83 x 51 cm, Abstand zwischen den Borden ca. 26 cm, Tragfähigkeit 120 kg, 4 Lenkrollen, davon 2 feststellbar, Lieferung demontiert, einfache Montage

with 3 trays, trays approx. 83 x 51 cm, size between the trays approx. 26 cm, total load capacity 120 kg, 4 wheels with 2 brakes, unassembled, simple assembly

con 3 bandejas inox mate, aprox. 83 x 51 cm, la medida entre bandejas aprox. 26 cm capacidad total 120 kg, 4 ruedas con 2 frenos, construcción robusta, montaje fácil

3 niveaux, approx. 83x51 cm chacun, distance entre niveaux 26 cm, capacité maxi 120 kg au total, 4 roues dont 2 avec frein, construction robuste, montage facile

	cm	↑ cm	€
11979	91 x 59	93	156,00



Servier- / Transportwagen

service trolley
carro de servicio
chariot de service



mit 2 Borden, Bordmaße ca. 83 x 51 cm, Abstand zwischen den Borden ca. 56 cm, Tragfähigkeit 80 kg, 4 Lenkrollen, davon 2 feststellbar, Lieferung demontiert, einfache Montage

with 2 trays, trays approx. 83 x 51 cm, size between the trays approx. 56 cm, total load capacity 80 kg, 4 wheels with 2 brakes, unassembled, simple assembly

con 2 bandejas de acero inoxidable mate, aprox. 83 x 51 cm, la medida entre bandejas aprox. 56 cm, capacidad total 80 kg, 4 ruedas, con 2 frenos, construcción robusta, montaje fácil

2 niveaux, approx. 83x51 cm chacun, distance entre niveaux 56 cm, capacité maxi 80 kg au total, 4 roues dont 2 avec frein, construction robuste, montage facile

	cm	↑ cm	€
11977	91 x 59	93	134,00



GN 1/1 Regalwagen

GN 1/1 trolley
carro GN 1/1
GN 1/1 chariot



mit 15 Doppelauflegeschielen, zum Transport von bis zu 30 GN-Tablets GN 1/2 oder 15 GN-Behältern bis GN 1/1 (Längseinschub), bei einem Stapelabstand von 75 mm, mit 4 Lenkrollen, 2 mit Feststellern, Tragfähigkeit 100 kg

15 double bars, for transporting up to 30 trays GN 1/2 or 15 GN-containers up to GN 1/1, size between the trays 75 mm, 4 swivel wheels, 2 equipped with brakes total load capacity 100 kg

15 pares de rieles dobles para el transporte de hasta 30 bandejas o 15 cubetas GN 1/1 (apertura por el lado estrecho) distancia entre las bandejas de 75 mm, 2 ruedas giratorias con frenos, carga máxima 100 kg

15 rails doubles pour maxi 30 plateaux GN 1/2 ou 15 plateaux GN 1/1 (ouverture sur le côté étroit 32,5cm), espace entre plateaux 75 mm, 2 roues pivotantes avec frein, charge maxi 100 kg

	cm	↑ cm	€
71441	55 x 38,5	173,5	254,00



mit beidseitiger Kipp- und Durchschubsicherung



Servier- / Transportwagen

serving trolley
carro de servicio
chariot de service



Aluminiumrahmen, 3 Böden, Abstand zwischen den Böden 31 cm, mit 4 Lenkrollen, alle mit Feststellern, Tragfähigkeit: ca. 80 kg je Boden, 240 kg insgesamt, demontiert, einfache Montage, Lieferung ohne Container und Dekoration

frame aluminium, 3 shelves, distance between shelves 31 cm, 4 swivel wheels, all equipped with brakes, max. load per shelf 80 kg, 240 kg total, demounted, easy to mount, delivery without containers and decoration

marco aluminio, 3 pisos, distancia entre cada piso 31 cm, 4 ruedas giratorias, las 4 con frenos, carga máxima por bandeja 80 kg, 240 kg en total, se sirve desmontado, fácil de montar (se entrega sin contenedores ni decoración)

chassis aluminium, 3 étages, distance entre niveaux 31 cm, 4 roues pivotantes, toutes avec frein, charge maximum 80 kg par niveau, 240 kg au total, livré démonté, montage facile (livré sans récipients ni décoration)

	cm	↑ cm	€
11945	108 x 50	96	114,00



Container

container
contenedor
récipient



zum Einhängen, passend zum Servier- / Transportwagen 11945

to hang up, suitable serving trolley 11945

para colgar, adaptado para el carro ref. 11945

à suspendre, pour chariot de service 11945

	cm	↑ cm	ltr.	€
11946	33 x 23	56,5	42	28,00
11947	33 x 23	17,5	13	14,00

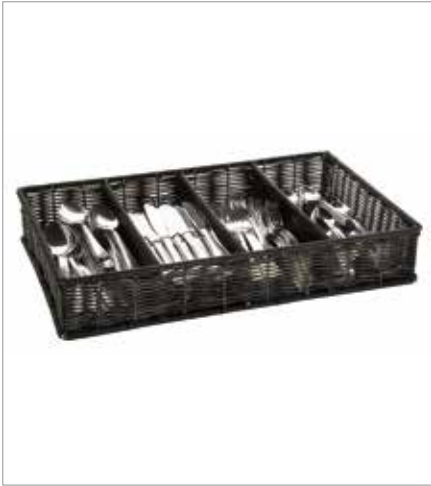

GN 1/1 Besteckbehälter

GN 1/1 dispenser GN
GN 1/1 dispensador de cubiertos
GN 1/1 bac à couverts



in Handarbeit geflochten, 4 Mulden, Kunststoff-Geflecht, Drahtgestell, braun-schwarz
wickerwork, 4 compartments, with reinforced chromed wire structure, brown-black
cesta trensada a mano, 4 compartimentos, de plástico, con bastidor cromado reforzado, marrón oscuro
corbeille tressée à main, 4 compartiments, en plastique, cadre acier chromé renforcé, couleur marron foncé

	cm	↑ cm	Farbe / Colour	€
11966	53 x 32,5	9		33,00



GN 1/1 Besteckbehälter „BUFFET“

GN 1/1 cutlery dispenser
GN 1/1 dispensador de cubiertos
GN 1/1 bac à couverts



4 Mulden, Kunststoff-Geflecht, Drahtgestell, beige
4 troughs, wickerwork, wire, beige
4 huecos, trabajo de cestería
4 compartiments, plastique tressé, cadre acier chromé renforcé, couleur osier naturel

	cm	↑ cm	Farbe / Colour	€
11965	53 x 32,5	10		24,00



GN 1/1 Besteckbehälter

GN 1/1 cutlery tray / box stand
GN 1/1 dispensador de cubiertos
GN 1/1 bac à couverts



	cm	↑ cm	Farbe / Colour	€
11955	53 x 32,5	10		6,00



GN 1/1 Besteckkasten

cutlery box GN 1/1
GN 1/1 dispensador de cubiertos
GN 1/1 bac à couverts



	cm	↑ cm	Farbe / Colour	€
11960	53 x 32,5	10		6,60





Besteckständer „TRIPLE TOWER“

cutlery basket
cesta para cubiertos
égouttoir à couverts



4-teiliges Set: 1 Gestell + 3 Köcher

4 pcs. set: 1 frame + 3 baskets

set de 4 piezas: 1 estructura + 3 cubiertos

set de 4 éléments: 1 structure + 3 corbeille

variable
Nutzungsmöglichkeiten
variable usage possibilities

	cm	↑ cm	Farbe / Colour	€
11466	18 x 26	43	White	79,00
11467	18 x 26	43	Black	79,00



Besteckköcher

cutlery basket
cesta para cubiertos
corbeille à couverts



	cm	↑ cm	Farbe / Colour	€
84535	12 x 12	16	White	4,90
84536	12 x 12	16	Black	4,90



Table Caddy „COUNTRY STYLE“

table barrel
caddy de mesa
caddy de table



cooler Country-Style, nicht für den direkten Kontakt mit Lebensmittel verwendbar

make for cool condiment and cutlery holders or even for food presentation, the mini barrels should not come into contact with food, they should be lined with our greaseproof paper

estilo campo, no aptos para el contacto directo con alimentos, sólo usando papel alimenticio

de style champêtre, pas de contact direct avec aliments, seulement en utilisant papier alimentaire

	Ø cm	↑ cm	€
11930	17,5	8,5	19,00
11931	11,5	14,0	19,00



Tischreste- / Besteckbehälter „TOP CHROME“

table waste bin / cutlery bin
papelera de sobremesa / recipiente para cubiertos
poubelle de table / récipients pour couverts



mit verchromten Rand

with chrome plated ring

con anillo cromado

avec bord chromé

	Ø cm	↑ cm	ltr.	Farbe / Colour	€
00025	13	15	1	White	6,00
00026	13	15	1	Black	6,00



Tischreste- / Besteckbehälter „BASE CHROME“

table waste bin / cutlery bin
papelera de sobremesa / recipiente para cubiertos
poubelle de table / récipients pour couverts



	Ø cm	↑ cm	ltr.	Farbe / Colour	€
00019	13	15	1,3	White	6,00
00020	13	15	1,3	Black	6,00

mit verchromten Boden / with chrome bottom



Besteckbehälter „ELEMENT“

cutlery bin
recipiente para cubiertos
récipients pour couverts



mit Abflussloch, mit Besteck Logo, Bodeneinlagen aus Silikon zum Schonen der Messerspitzen, möbelschonende Unterseite

with drain hole, with cutlery logo, silicone floor inserts for saving the points of knives, with non-scratching undersurface

con orificio de drenaje, con logotipo de cubertería, soporte de silicona para proteger las puntas de los cuchillos, con base antirrayaduras

avec le trou de drainage, avec le logo de coutellerie, insert de silicone pour protéger les pointes des couteaux, avec base revêtue antirayures

	Ø cm	↑ cm	€
00018	11	14	14,50



Besteckbehälter

cutlery basket
dispensador de cubiertos
présentoir à couverts



matt poliert

satin polished finish

inox mate (sin cubiertos)

inox mat

	cm	↑ cm	€	
11994	26,0 x 30 Ø 10	20	4 Löcher inkl. Köcher (Kunststoff) 4 holes incl. dispensers (plastic) 4 agujeros incl. dispensador plástico 4 places, avec 4 récipients (plastique)	62,00
11996	26,0 x 30 Ø 10	20	4 Löcher ohne Köcher 4 holes without dispensers 4 agujeros sin dispensador de plástico 4 places, sans récipients	56,00
11997	37,5 x 30 Ø 10	20	6 Löcher ohne Köcher 6 holes without dispensers 6 agujeros sin dispensador de plástico 6 places, sans récipients	77,00



Besteckbehälter

cutlery basket
recipiente para cubiertos
récipients pour couverts



4 Löcher inkl. 4 Edelstahl Köcher

4 holes incl. 4 stainless baskets

4 agujeros, incl. 4 cestas de acero

4 places, avec 4 corbeille inox

	cm	↑ cm	Farbe / Colour	€
93321	27 x 27	15	■	69,00



Besteckköcher

cutlery basket
cesta para cubiertos
corbeille à couverts



	Ø cm	↑ cm	€	
11998	9,7	13,7	Kunststoff weiß / white plastic plástico blanco / plastique blanc	2,50
11999	9,7	13,7	matt poliert / satin polished finish acero inoxidable / inox	7,90

11998
Köcher weiß
PE white

11999
Köcher Edelstahl
stainless steel



Besteckkorb „ECONOMIC“

cutlery dispenser
dispensador de cubiertos
corbeille à couverts



in Handarbeit geflochten
wickerwork
trensado a mano
tressage à main

	Ø cm	↑ cm	Farbe / Colour	€
40130	12	15		3,20
40007	12	15		3,20
40012	12	15		3,20
40013	12	15		3,20



Besteckkorb „ECONOMIC“

cutlery dispenser
dispensador de cubiertos
corbeille à couverts



in Handarbeit geflochten
wickerwork
trensado a mano
tressage à main

	cm	↑ cm	Farbe / Colour	€
40131	27 x 10	4,5		3,20
40009	27 x 10	4,5		3,20
40010	27 x 10	4,5		3,20
40011	27 x 10	4,5		3,20



Sortierbox „MULTI“

shape sorter
caja surtida
boîte de tri



inklusive 3 herausnehmbare Trennwände, 4 Kammern
including 3 removable divider, 4 chambers
con 3 divisores extraíbles, 4 compartimentos
avec 3 parois de séparation amovibles, 4 compartiments

	cm	↑ cm	ltr.	Farbe / Colour	€
84531	31,5 x 17,5	7	2,1		19,00
84532	31,5 x 17,5	7	2,1		19,00



Tischreste- / Besteckbehälter

table garbage bin / cutlery bin
 papelera de sobremesa / recipiente para cubiertos
 poubelle de table / récipients pour couverts



matt poliert, mit abnehmbaren Lochdeckel
 satin polished finish, with removeable cover
 acabado pulido satinado, con tapa desmontable
 poli mat satiné, avec couvercle démontable ouvert au centre

	Ø cm	↑ cm	ltr.	€
00028	10	12	0,7	12,00

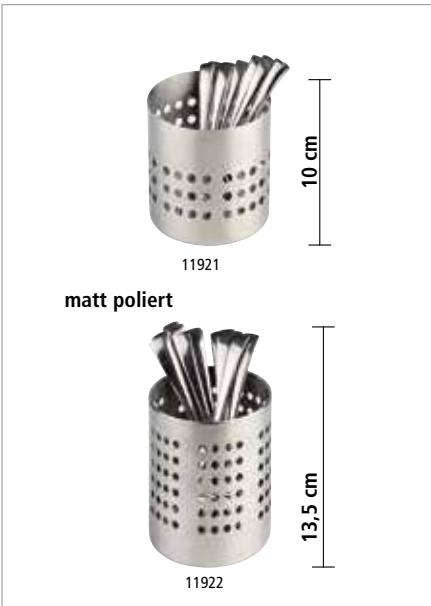

Besteckständer

cutlery basket
 cesta para cubiertos
 égouttoir à couverts



matt poliert
 satin polished finish
 inox mate (sin cubiertos)
 inox mat

	Ø cm	↑ cm	€
11921	10	10,0	7,40
11922	12	13,5	9,90



Eier-Box

eggs box
 caja para huevos
 boîte à oeufs



mit luftdichtem Deckel, für 4 Lagen à 30 Eier, Lieferung inkl. 8 Lagen, Größe Lage: 28 x 28 cm
 with airtight cover, capacity: 4 trays of 30 eggs, delivery with 8 trays, size of tray: 28 x 28 cm
 capacidad para 4 bandejas de 30 huevos, tapa hermética, se entrega con 8 bandejas, formato bandejas 28 x 28 cm, apto para lavavajillas
 pour 4 plateaux de 30 oeufs chacun, apte pour 4 plateaux plats, couvercle hermétique, livré avec 8 plateaux, dimension plateau 28x28 cm, lavable en lave-vaisselle

	cm	↑ cm	GN	€
82419	35,4 x 32,5	20	2/3	34,00

10 Lagen / 10 trays / 10 bandejas / 10 plateaux

82420				23,00
-------	--	--	--	-------



Rechteckschalen

container
 cubeta
 bac



	cm	↑ cm	ltr.	€
11941	30 x 21,0	6,5	2	4,00
11942	34 x 23,5	7,0	3	5,20
11943	48 x 33,0	8,0	8	11,00



Wanne
container
cubeta
bac



	cm	↑ cm	ltr.	€
11940	61 x 44	15	25	21,60



Geschirrwanne
container
cubeta para vajilla
bac à vaisselle



	cm	↑ cm	€
11950	55 x 42	14	10,00



Serviertablett „RUTSCHFEST“

tray non-slip
bandeja antideslizante
plateau antiglisse



rutschfeste Oberfläche
non-slip surface
superficie anti-deslizante
surface antidérapante

	cm	↑ cm	GN	Farbe / Colour	€
00502	53,0 x 32,5	1,5	1/1		21,90
00508	46,0 x 36,0	2			20,80
00505	53,0 x 32,5	1,5	1/1		21,90
00503	53,0 x 37,0	1,5			25,00



Fast Food Tablett

snack tray
bandeja autoservicio y snacks
plateau self-service et snacks



	cm	↑ cm	GN	Farbe / Colour	€
00530	35 x 27	2			3,10
00535	41 x 30,5	2			4,10
00540	45 x 35,5	2			5,10
00552	53,0 x 32,5	2	1/1		6,20

	cm	↑ cm	GN	Farbe / Colour	€
00531	35 x 27	2			3,10
00536	41 x 30,5	2			4,10
00541	45 x 35,5	2			5,10
00553	53,0 x 32,5	2	1/1		6,20

	cm	↑ cm	GN	Farbe / Colour	€
00532	35 x 27	2			3,10
00537	41 x 30,5	2			4,10
00542	45 x 35,5	2			5,10
00554	53,0 x 32,5	2	1/1		6,20

	cm	↑ cm	GN	Farbe / Colour	€
00533	35 x 27	2			3,10
00538	41 x 30,5	2			4,10
00543	45 x 35,5	2			5,10
00555	53,0 x 32,5	2	1/1		6,20





Bar, Café Drinkware

Sektkühler
Shaker
Barmaß
Aschenbecher
Tabletts

cubiteras
cocteleras
medidores jigger
ceniceros
bandejas

champagne bowls
shakers
jiggers
ashtrays
trays

seaux à champagne
shakers
mesures jigger
cendriers
plateaux



Flaschenkühler „MOSCOW MULE“

bottle cooler
enfriador de botellas
rafraîchisseur de bouteilles

Edelstahl-Flaschenkühler, Antik-Kupfer-Look
stainless steel cooler, copper antique look
enfriador de acero inoxidable, cobre estilo antiguo
rafraîchisseur en acier inox, cuivre style antique



	Ø cm	↑ cm	ltr.		€
93330	20	21	5	copper-antique-hammered	44,00



Wein- / Sektkühler „TROPHY“

wine / champagne bowl
cubitera para vino y cava
seau à vin ou champagne

hochglanzpoliert, mit Griffen, Fuß Ø 18,5 cm,
mirror polished finish, with handles, foot Ø 18,5 cm
pulido brillante, 2 asas, pie ø 18,5 cm
brillant, 2 anses, pied ø 18,5 cm



	Ø cm	↑ cm	ltr.		€
36092	23	24	5	stainless-steel	29,00
36093	23	24	5	copper-look	32,00



Wein- / Sektkühler

wine / champagne bowl
cubitera para vino y cava
seau à vin ou champagne

matt poliert, Hohlgriffe
satin polished finish, hollow handles
acabado pulido satinado, con asas huecas
finition mate, 2 boutons creux



	Ø cm	↑ cm	ltr.		€
36021	20 / 15	20,5	4		13,50



Wein- / Sektkühler

wine / champagne bowl
cubitera para vino y cava
seau à vin ou champagne

aussen hochglanzpoliert, innen matt poliert, mit Ring-Griffen
outside mirror polished finish, inside satin polished finish, with ring handles
exterior pulido brillante, interior efecto satinado con 2 asas anillos
extérieur brillant, intérieur satin, avec 2 anneaux



	Ø cm	↑ cm	ltr.		€
36020	20 / 15	19	3		12,00



Mini-Eiseimer / Mini-Sektkühler

ice bucket
cubitera clásica
seau à glaçons classique



	Ø cm	↑ cm	ltr.		€
36003	10,5	10	0,65		8,00
36004	13	13	1,0		10,00



Wein- / Sektkühler

wine / champagne bowl
cubitera para vino y cava
seau à vin ou champagne

mit seitlichen Griffen, transparent
with lateral handles, transparent
con asas laterales
avec poignées latérales



	cm	↑ cm	ltr.	€
36081	20 x 20	20	4,5	17,40



Wein- / Sektkühler

wine / champagne bowl
cubitera para vino y cava
seau à vin ou champagne

glasklarer Rand, transparent gefrostet
edge transparent, body transparent frosted
borde transparente, cuerpo transparente efecto glaseado
bord transparent, corps finition mate



	Ø cm	↑ cm	ltr.	€
36066	22 / 14	23	4	8,70



Wein- / Sektkühler

wine / champagne bowl
cubitera para vino y cava
seau à vin ou champagne

innen mattiert, außen hochglanz, mit massiven Knopf-Griffen, extra stabiler eingerollter Rand, schwere Ausführung

outside mirror polished finish, inside satin polished finish, with solid knob handles, rolled edge, heavy quality
acabado pulido brillante, asas de botón robustas, borde redondeado, alta calidad
brillant, 2 poignées robuste en forme de bouton, bord arrondi, haute qualité



	Ø cm	↑ cm	ltr.	€
36028	21,5 / 16	22	4	21,00



Wein- / Sektkühler

wine / champagne bowl
cubitera para vino y cava
seau à vin ou champagne

innen mattiert, außen poliert, mit massiven Griffen, Rand eingerollt

outside mirror polished finish, inside satin polished finish, with massive handles, rolled edge
pulido mate, 2 asas macizas, borde redondeado
finition mate, 2 anses massives, bord rond



	Ø cm	↑ cm	ltr.	€
36025	21 / 15	21	3,5	16,00



Wein- / Sektkühler „HAMMERSCHLAG“

wine / champagne bowl
cubitera para vino y cava
seau à vin ou champagne

hochglanzpoliert, mit massiven Ring-Griffen, eingerollter Rand

mirror polished finish, with solid ring handles, rolled edge, hammered
acabado pulido brillante, con 2 anillos macizos, borde redondeado, repujado
brillant, 2 anneaux massifs, bord arrondi, surface martelée



	Ø cm	↑ cm	ltr.	€
36026	21 / 17	21,5	4	15,00



Wein- / Sektkühler
 wine / champagne bowl
 cubitera para vino y cava
 seau à vin ou champagne



glasklar, mit Tragegriff
 transparent, handle on the side
 transparente, con un asa en el lateral
 transparent, avec poignée

	cm	↑ cm	ltr.	€
36055	23 x 22	27,5	3	17,00



Ständer für Wein- / Sektkühler
 stand for wine / champagne bowl
 pie porta champañera / vino
 pied pour seau à champagne / vin



hochglanzpoliert, schwerer standsicherer Fuß, Innendurchmesser der Schale Ø 17,5 cm
 mirror polished finish, heavy foot, inner bowl Ø 17,5 cm
 acabado pulido efecto brillante, bol interior de Ø 17,5 cm
 brillant, intérieur support Ø 17,5 cm

	Ø cm	↑ cm	€
36069	17,5 / 26,5	73	99,00



Wein- / Sektkühler no. 36028
 wine / champagne bowl no. 36028
 cubitera para vino y cava no. 36028
 seau à vin ou champagne no. 36028



Ständer für Wein- / Sektkühler
 stand for wine / champagne bowl
 pie porta champañera / vino
 pied pour seau à champagne / vin



hochglanzpoliert, schwerer standsicherer Fuß, Innendurchmesser der Schale Ø 15 cm
 mirror polished finish, heavy foot, inner bowl Ø 15 cm
 acabado pulido efecto brillante, bol interior de Ø 15 cm
 brillant, intérieur support Ø 15 cm

	Ø cm	↑ cm	€
36068	15 / 28	68	79,00



Tischhalterung für Sektkühler
 champagne bucket table holder
 soporte champañera universal
 porte-seau à champagne



aus 8 mm starkem Stahldraht, passen zu allen lieferbaren Sektkühlern, innen Ø-Ring: 18 cm
 8 mm chrome plated wire, suitable for all available champagne buckets
 alambre cromado 8 mm, para todas las champañeras
 fil chromé 8 mm, pour tous les seaux à champagne

	cm	↑ cm	€
30332	49 x 20	17	11,00

NEW



11 ltr.

36095



18 ltr.

36096

Getränkewanne „TIN“

beverage tub
barreño botellines
bassine à glace



Metall verzinkt, mit Kunststoffeinsatz

galvanised metal, with plastic insert
metal galvanizado, con inserto de plástico
métal galvanisé, avec insert en plastique

	Ø cm	↑ cm	ltr.	€
36095	40 x 28	22	11	24,00
36096	50 x 32	23	18	29,00



mit Kunststoffeinsatz
with plastic insert
con inserto de plástico
avec insert en plastique

NEW



Flaschen- / Getränkekühler

bottle / beverage cooler
enfriador de botellas / bebidas
rafraîchisseur de bouteilles / boissons



glasklar
transparent
transparente
transparent

	cm	↑ cm	ltr.	€
36091	45 x 42	19/25	11	29,00

Flaschenkühler / Getränkeschale

bottle cooler / bowl
enfriador de botella
rafraîchisseur de bouteille



mit seitlichen Griffen, transparent
with lateral handles, transparent
con asas laterales
avec poignées latérales

	cm	↑ cm	ltr.	€
36082	35,5 x 35,5	20	16	38,00

Wein- / Sektkühler

wine / champagne bowl
cubitera para vino y cava
seau à vin ou champagne



mit seitlichen Griffen, transparent
with lateral handles, transparent
con asas laterales
avec poignées latérales

	cm	↑ cm	ltr.	€
36087	32 x 21,5	24,5	7	23,00



Flaschenkühler „BRIDGE“

bottle cooler
enfriador de botellas
rafraîchisseur de bouteilles



doppelwandig für beste Isolierung, außen poliert, innen mattiert
double wall cooler keeps the temp. for a long time, outs. mirror polished, inside matt finish
champañera inox de doble pared, interior mate, exterior brillante
seau inox double paroi, maintient le froid plus longt., intérieur mat, extérieur poli brillant

	Ø cm	↑ cm	ltr.	€
36077	31	19	10	98,00



Konferenzkühler „BRIDGE“ no. 13985

bottle cooler no. 13985
enfriador no. 13985
rafraîchisseur no. 13985



Champagnerkühler

champagne bowl
cubo champañera
seau à champagne



außen hochglanzpoliert, innen matt poliert, mit vergoldeten Griffen
outside mirror polished finish, inside satin polished finish, with gold plated handles
exterior pulido brillante, interior satinado
extérieur brillant, intérieur satin

	Ø cm	↑ cm	ltr.	€
36047	42 / 27	28	20	79,00



Champagnerkühler

champagne bowl
cubo champañera
seau à champagne



hochglanzpoliert, Lieferung ohne Gläser-Ring
mirror polished finish, delivery without holder
acabado efecto brillante, se entrega sin el aro colgador para copas
brillant, livré sans le support à flûtes

	Ø cm	↑ cm	ltr.	€
36045	40,5 / 27,5	22,5	13,5	49,90



Champagnerkühler

champagne bowl
cubo champañera
seau à champagne



hochglanzpoliert, Rand matt poliert
mirror polished finish, edge satin polished finish
acabado pulido brillante, borde satinado
brillant, bord mat

	Ø cm	↑ cm	ltr.	€
36046	45 / 21	23	12	39,90



Wein- / Sektkühler

wine / champagne bowl
cubitera para vino y cava
seau à vin ou champagne

glasklar, für bis zu 6 Flaschen geeignet
transparent, suitable for up to 6 bottles
transparente, para máximo 6 botellas
transparent, maxi 6 bouteilles



	cm	↑ cm	ltr.	€
36057	47 x 28	23	10	36,00



Wein- / Sektkühler

wine / champagne bowl
cubitera para vino y cava
seau à vin ou champagne

mit 2 seitlichen Eingriffen
with 2 handles on the side
con 2 asas
avec 2 poignées



	cm	↑ cm	ltr.	Farbe / Colour	€
36048	35 x 27	25,5	6	White	28,00
36052	27 x 20	21	3	White	16,00



Wein- / Sektkühler

wine / champagne bowl
cubitera para vino y cava
seau à vin ou champagne

mit 2 seitlichen Eingriffen
with 2 handles on the side
con 2 asas
avec 2 poignées



	cm	↑ cm	ltr.	Farbe / Colour	€
36054	35 x 27	25,5	6	Black	30,00
36053	27 x 20	21	3	Black	18,00



Wein- / Sektkühler

wine / champagne bowl
cubitera para vino y cava
seau à vin ou champagne

glasklar, für zwei Flaschen
transparent, for two bottles
transparente, para 2 botellas
transparent, pour 2 bouteilles



	cm	↑ cm	ltr.	€
36056	30,5 x 21,5	26	4	19,50



Champagnerkühler

champagne bowl
cubo champañera
seau à champagne

hochglanzpoliert, doppelwandig
mirror polished finish, double wall
acabado pulido brillante con doble pared
brillant, double paroi

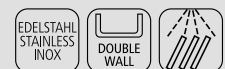

	Ø cm	↑ cm	ltr.	€
36044	44 / 25	24	10,5	96,00



Flaschenkühler „COPPER“

bottle cooler
enfriador de botella
rafraîchisseur de bouteille



Hammerschlagoptik, doppelwandig für beste Isolierung, für 0,7 - 1,5 Liter-Flaschen

double wall cooler keeps the temperature for a long time, hammered look, for 0,7 - 1,5 ltr. bottles
doble pared para mantener el frío largo tiempo, botellas de 0,7 - 1,5 ltr.
double paroi pour une meilleure conservation de la température, pour bouteilles de 0,7 à 1,5 l.

	Ø cm	↑ cm	Farbe / Colour	€
36074	12 / 10	20		23,00

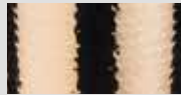

1:1 Oberflächenansicht
1:1 structural view



Flaschenkühler

bottle cooler
enfriador de botella
rafraîchisseur de bouteille



matt poliert, doppelwandig für beste Isolierung, für 0,7 - 1,5 Liter-Flaschen

satin polished finish, double wall cooler keeps the temperature for a long time, for 0,7 - 1,5 ltr. bottles

acero inoxidable mate con doble pared para mantener el frío largo tiempo, botellas de 0,7 - 1,5 ltr.

inox mat, double paroi pour une meilleure conservation de la température, pour bouteilles de 0,7 à 1,5 l.

	Ø cm	↑ cm	€
36030	12 / 10	20	16,00



Flaschenkühler

bottle cooler
enfriador de botella
rafraîchisseur de bouteille



matt poliert, taillierte Form, doppelwandig für beste Isolierung, für 0,5 - 1,5 Liter-Flaschen

satin polished finish, waisted form, double wall, for 0,5 - 1,5 ltr. bottles

acabado pulido mate, diseño „entallado“, con doble pared para botellas de 0,5 a 1,5 ltr.

inox mat, forme design, double paroi pour une meilleure conservation de la température, pour bouteilles de 0,5 à 1,5 l.

	Ø cm	↑ cm	€
36038	12,5 / 10	19	21,00



Flaschenkühler „CLASSIC“

bottle cooler
enfriador de botella
rafraîchisseur de bouteille



edler Kunststoffmantel in matt-metall Optik, Rand hochglanzpoliert, speziell isolierter Kunststoffeinsatz sorgt für beste Kühlung, für 0,5 - 1,5 Liter-Flaschen, Material: Mylar

noble plastic jacket in satin metal look, mirror polished finish edge, special insulated plastic insert, for 0,5 - 1,5 ltr. bottles, material: mylar

plástico imitación metal aspecto satinado, borde brillante, aislado interior especial para botellas de 0,5 a 1,5 ltr., material: mylar

plastique aspect métal satiné, bord brillant, paroi intérieure spécialement isolante pour bouteilles de 0,5 à 1,5 l., matière: mylar

	Ø cm	↑ cm	€
36036	12,5 / 10	22	14,20



Flaschenkühler „ELEMENT BLACK“

bottle cooler
enfriador de botella
rafraîchisseur de bouteille



Beton, mit möbelschonender Unterseite
concrete, with non-scratching undersurface
hormigón, con base anti rayaduras
béton, avec base revêtement antirayures

	Ø cm	↑ cm	€
36099	12 / 10	19	16,00



Flaschenkühler „ELEMENT“

bottle cooler
enfriador de botella
rafraîchisseur de bouteille



Beton, mit möbelschonender Unterseite
concrete, with non-scratching undersurface
el hormigón, con base antirrayaduras
le béton, avec base revêue antirayures

	Ø cm	↑ cm	€
36090	12 / 10	19	16,80



Flaschenkühler

bottle cooler
enfriador de botella
rafraîchisseur de bouteille



Rand matt poliert, doppelwandig für beste Isolierung, für 0,7 - 1,5 Liter Flaschen

satin polished finish edge, double wall cooler keeps the temperature for a long time, for 0,7 - 1,5 ltr. bottles
borde pulido satinado, con doble pared para mantener más tiempo la temperatura para botellas de 0,7 a 1,5 l.
bord métallique mat, double paroi pour excellente conservation de la température, pour bouteilles de 0,7 à 1,5 l.

	Ø cm	↑ cm	€
36050	11,5 / 9,5	23	18,90



Flaschenkühler „CRYSTAL“

bottle cooler
enfriador de botella
rafraîchisseur de bouteille



doppelwandig für beste Isolierung, glasklar
doublewall, clear
doble pared
double paroi

	Ø cm	↑ cm	€
36062	13,5 / 10,5	23	7,90



Flaschenkühler „PURE“

bottle cooler
enfriador de botella
rafraîchisseur de bouteille



doppelwandig für beste Isolierung, glasklar
doublewall, clear
doble pared
double paroi

	Ø cm	↑ cm	€
36063	13,5 / 10,5	23	7,90



hot price

Flaschenkühler

bottle cooler
enfriador de botella
rafraîchisseur de bouteille



transparent, doppelwandig für beste Isolierung, mit Chromrand

transparent, double wall cooler keeps the temperature for a long time, with chrome edge
transpar., doble pared mantiene la temperatura por largo tiempo, borde superior cromado
transparent, bord chromé brillant, double paroi pour maintien en température

	Ø cm	↑ cm	Farbe / Colour	€
36032	12 / 10	23		6,90



hot price

Flaschenkühler

bottle cooler
enfriador de botella
rafraîchisseur de bouteille



transparent, doppelwandig für beste Isolierung, mit Chromrand

transparent, double wall cooler keeps the temperature for a long time, with chrome edge
transpar., doble pared mantiene la temperatura por largo tiempo, borde superior cromado
transparent, bord chromé brillant, double paroi pour maintien en température

	Ø cm	↑ cm	Farbe / Colour	€
36034	12 / 10	23		6,90



Kühlmanschette „WINE“

cool collar
funda enfriadora
manchette rafraîchissante



für Mineralwasser- und Weinflaschen, Aktivkühler, ohne Eis, nach 5 Minuten gekühlt, Aufbewahrung im Gefrierfach

for soda- and winebottles, active chiller without ice, chilled in 5 minutes, keep in the freezer
para botellas de agua embotellada y vino, enfría sin hielo, en sólo 5 minutos, guardar en el congelador

refroidit en 5 minutes, sans glace, conserver au congélateur, pour l'eau embouteillée et les bouteilles de vin

	cm	↑ cm	Farbe / Colour	€
36083	14 x 2	17,5		8,40



Kühlmanschette

cool collar
funda de frío
housse isotherme



für Sekt- / Champagnerflaschen, einfach im Gefrierfach einfrieren, komplette Flasche wird in 5 Min. auf angenehme Trinktemperatur gekühlt, außen reißfestes Stoffgewebe, innen Kunststoff mit Kühlgel gefüllt, unbegrenzt wiederverwendbar

for bottles of champagne, simply to freeze in the freezer, complete bottles will be cooled down in only 5 minutes, tearproof cloth outside, plastic filled with gel inside, unlimited reusable
para botellas de cava o champán simplemente congelándola en el congelador, la botella entera se enfriará en 5 minutos, funda de plástico muy robusta, rellena con un gel congelante reutilizable ilimitadamente

pour bouteilles de vin ou champagne, la housse est préalablement stockée au congélateur, où elle accumule le froid, ensuite elle refroidit une bouteille en quelques minutes, plastique résistant, contient un liquide congelant, à réutiliser de façon illimitée

	Ø cm	↑ cm	Farbe / Colour	€
36075	11	18		6,00



Weinflaschenhalter
winebottle-stand
soporte para botella de vino
porte-bouteille



	cm	↑ cm	€
30333	22 x 6	20,5	6,90



Gläserschiene
glass rack
rack de copas
rack porte-verres



aus 6 mm verchromten Draht, Wand- und Deckenmontage möglich, bietet Platz für 20 Gläser
6 mm chrome plated wire, can be mounted under a shelf or on the wall, for 20 glasses
alambre cromado de 6 mm, puede instalarse bajo una estantería o en la pared para 20 copas
fil chromé de 6 mm, à installer sous une étagère ou contre un mur, pour 20 verres à pied

	cm	↑ cm	€
93400	45 x 32	6	29,00



Flaschenträger
bottle rack
porta botellas
porte-bouteilles



für 6 Flaschen, Ring Ø 9,5 cm
for 6 bottles, ring Ø 9,5 cm
para 6 botellas, Ø 9,5 cm
pour 6 bouteilles, Ø 9,5 cm

	cm	↑ cm	€
00630	32 x 21,5	32,5	11,20



Bierglasträger
beer rack
porta vasos de cerveza
porte verres à bière



für Glasgrößen 0,2 - 0,3 Liter, für 10 Gläser, Ring Ø 6,5 cm
for glasses size 0,2 - 0,3 liter, for 10 glasses, ring Ø 6,5 cm
para vasos tamaño 0,2-0,3 l, para 10 vasos, Ø 9,5 cm
pour verres de 0,2 à 0,3 l, pour 10 verres, Ø 9,5 cm

	cm	↑ cm	€
00632	40 x 16,5	29	17,00

CRYSTAL

0,15 - 0,30 - 0,50 ltr.



Trinkbecher „CRYSTAL“

drinking cups

vasos

gobelets



Kristallglas-Optik, vielseitig einsetzbar, robustes, unzerbrechliches Material, ideal in sensiblen Bereichen wie Pool, Spa, Beach und Wellness einzusetzen, BPA-frei

crystal-glass-look, can be used in versatile ways, a solide and unbreakable material, ideal to be used in pool, spa, beach and wellness areas, bpa-free

look de vidrio, se pueden utilizar de muchas maneras diferentes, material sólido e irrompible, ideal para el uso en áreas como piscina, spa, playa y bienestar, libre de BPA

look de verre de cristal, peuvent être utilisés de différentes façons, matériau robuste et incassable, idéal pour une utilisation dans des zones comme la piscine, le spa, la plage et le bien-être, sans BPA

	Ø cm	↑ cm	ltr.	VE	Farbe / Colour	€/ pc.
10500	7	9,5	0,15	48	—	2,00
10501	8	12,5	0,30	48	—	2,80
10502	9	15,5	0,50	48	—	3,20

	Ø cm	↑ cm	ltr.	VE	Farbe / Colour	€/ pc.
10513 NEW	7	9,5	0,15	48		2,30
10514 NEW	8	12,5	0,30	48		3,10
10515 NEW	9	15,5	0,50	48		3,60

	Ø cm	↑ cm	ltr.	VE	Farbe / Colour	€/ pc.
10510 NEW	7	9,5	0,15	48		2,30
10511 NEW	8	12,5	0,30	48		3,10
10512 NEW	9	15,5	0,50	48		3,60



Trinkglas „BEACH“

drinking glass

vaso

verre



vielseitig einsetzbar, robustes, unzerbrechliches Material, ideal in sensiblen Bereichen wie Pool, Spa, Beach und Wellness einzusetzen, BPA-frei

can be used in versatile ways, a solide and unbreakable material, ideal to be used in pool, spa, beach and wellness areas, bpa-free

se pueden utilizar de muchas maneras diferentes, material sólido e irrompible, ideal para el uso en áreas como piscina, spa, playa y bienestar, libre de BPA

peuvent être utilisés de différentes façons, matériau robuste et incassable, idéal pour une utilisation dans des zones comme la piscine, le spa, la plage et le bien-être, sans BPA

	Ø cm	↑ cm	ltr.	VE	€/ pc.
10505	8,5	13,5	0,30	48	3,40

MOSCOW MULE



Flaschenkühler „MOSCOW MULE“
 bottle cooler
 enfriador de botellas
 rafraîchisseur de bouteilles



Edelstahl-Flaschenkühler, Antik-Kupfer-Look
 stainless steel cooler, copper antique look
 enfriador de acero inoxidable, cobre estilo antiguo
 rafraîchisseur en acier inox, cuivre style antique

	Ø cm	↑ cm	ltr.	Farbe / Colour	€
93330	20	21	5	copper-antique-hammered	44,00



Becher „MOSCOW MULE“, 2er-Set
 barrel copper mug, 2 pcs. set
 taza, set de 2
 gobelet, set de 2



Edelstahlbecher, Antik-Kupfer-Look
 stainless steel cup, copper antique look
 taza de acero inoxidable, cobre estilo antiguo
 gobelet en acier inox, cuivre style antique

	Ø cm	↑ cm	ltr.	Farbe / Colour	€/Set
93367	9	10	0,5	copper-antique-hammered	22,00

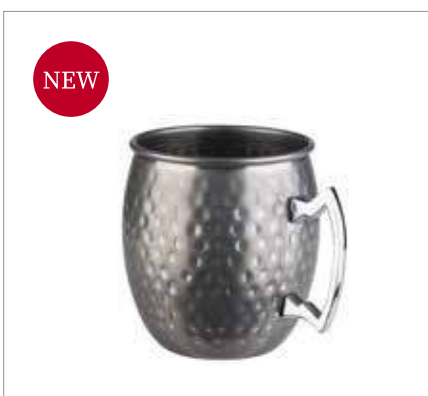

Becher „MOSCOW MULE“
 barrel mug
 taza
 gobelet



Edelstahlbecher, Antik-Edelstahl-Look
 stainless steel cup, stainless steel antique look
 taza de acero inoxidable, acero estilo antiguo
 gobelet en acier inox, acier style antique

	Ø cm	↑ cm	ltr.	Farbe / Colour	€
93346	9	10	0,5	stainless-antique-hammered	11,00



Becher „MOSCOW MULE“

barrel mug
taza
gobelet



Edelstahlbecher, Antik-Edelstahl-Look
stainless steel cup, stainless antique look
taza de acero inoxidable, acero estilo antiguo
gobelet en acier inox, acier style antique

	Ø cm	↑ cm	ltr.	Farbe / Colour	€
93345	9	9	0,45	stainless-antique	11,00



Becher „MOSCOW MULE“

barrel copper mug
taza
gobelet



Edelstahlbecher, Antik-Kupfer-Look
stainless steel cup, copper antique look
taza de acero inoxidable, cobre estilo antiguo
gobelet en acier inox, cuivre style antique

	Ø cm	↑ cm	ltr.	Farbe / Colour	€
93322	9	9	0,45	copper-antique	11,00



Becher „MOSCOW MULE“

barrel copper mug
taza
gobelet



Edelstahlbecher, Kupfer-Look, glänzend
stainless steel cup, copper look, highshine
taza de acero inoxidable, cobre, brillante
gobelet en acier inox, cuivre, brillant

	Ø cm	↑ cm	ltr.	Farbe / Colour	€
93310	9	9	0,45	copper	11,00



Becher „MOSCOW MULE“

barrel copper mug
taza
gobelet



Edelstahlbecher, Kupfer-Look, glänzend
stainless steel cup, copper look, highshine
taza de acero inoxidable, cobre, brillante
gobelet en acier inox, cuivre, brillant

	Ø cm	↑ cm	ltr.	Farbe / Colour	€
93311	9	10	0,50	copper hammered	11,00



Becher „MOSCOW MULE“

barrel copper mug
taza
gobelet



Edelstahlbecher, Antik-Kupfer-Look
stainless steel cup, copper look
taza de acero inoxidable, cobre estilo antiguo
gobelet en acier inox, cuivre style antique

	Ø cm	↑ cm	ltr.	Farbe / Colour	€
93323	9	10	0,50	copper-antique-hammered	11,00



Becher „MOSCOW MULE“

barrel mug
taza
gobelet



Edelstahlbecher, Antik-Edelstahl-Look
stainless steel cup, stainless antique look
taza de acero inoxidable, acero estilo antiguo
gobelet en acier inox, acier style antique

	Ø cm	↑ cm	ltr.	Farbe / Colour		€
93333	9,5	10	0,50		stainless-antique	11,00

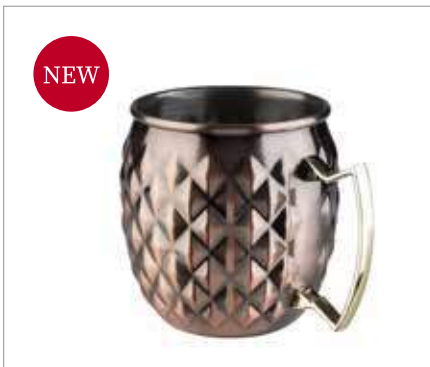

Becher „MOSCOW MULE“

barrel copper mug
taza
gobelet



Edelstahlbecher, Antik-Kupfer-Look
stainless steel cup, copper antique look
taza de acero inoxidable, cobre estilo antiguo
gobelet en acier inox, cuivre style antique

	Ø cm	↑ cm	ltr.	Farbe / Colour		€
93331	9,5	10	0,50		copper-antique	11,00

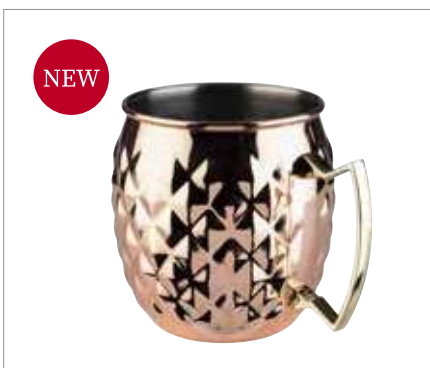

Becher „MOSCOW MULE“

barrel copper mug
taza
gobelet



Edelstahlbecher, Kupfer-Look, glänzend
stainless steel cup, copper look, glossy
taza de acero inoxidable, cobre, brillante
gobelet en acier inox, cuivre, brillant

	Ø cm	↑ cm	ltr.	Farbe / Colour		€
93332	9,5	10	0,50		copper	11,00



Becher „MINI SHOT“, 4er-Set

barrel mug 4 pcs. set
taza, set de 4
gobelet, set de 4



	Ø cm	↑ cm	ltr.	Farbe / Colour		€/Set
93342	4,5	4,5	0,05		copper-antique	19,90
93343	4,5	4,5	0,05		copper	19,90
93344	4,5	4,5	0,05		stainless-antique	19,90



Becher „COCKTAIL MUG“

barrel
taza
gobelet



	Ø cm	↑ cm	ltr.	Farbe / Colour		€
93370	8,5	14	0,5		stainless	14,90

JULEP MUG



NEW



0,40 ltr.

93336



0,40 ltr.

93337



0,40 ltr.

93338

Becher „JULEP MUG“ barrel mug taza gobelet



	Ø cm	↑ cm	ltr.	Farbe / Colour	€
93336	8	11,5	0,40	copper-antique-hammered	12,00
93337	8	11,5	0,40	copper hammered	12,00
93338	8	11,5	0,40	stainless-antique-hammered	12,00



0,35 ltr.

93327



0,35 ltr.

93328



0,35 ltr.

93329

Becher „JULEP MUG“ barrel mug taza gobelet



	Ø cm	↑ cm	ltr.	Farbe / Colour	€
93327	8,5	10,0	0,35	copper-antique	12,00
93328	8,5	10,0	0,35	copper	12,00
93329	8,5	10,0	0,35	stainless	12,00



Becher „MINI SHOT“ 4er-Set

barrel mug, 4 pcs. set
taza, set de 4
gobelet, set de 4



	Ø cm	↑ cm	ltr.	Farbe / Colour	€/Set
93339	4,5	5,5	0,06	copper-antique-hammered	19,90
93340	4,5	5,5	0,06	copper-hammered	19,90
93341	4,5	5,5	0,06	stainless-antique-hammered	19,90



Becher „BEER MUG“

barrel mug
taza
gobelet



Bierkrug, Antik-Look
beer mug, antique look
jarra de cerveza, estilo antiguo
chope, style antique

	Ø cm	↑ cm	ltr.	Farbe / Colour	€
93364	8,5	13,0	0,50	copper-antique	14,00
93365	8,5	13,0	0,50	stainless-antique	14,00



Becher „PINEAPPLE“

barrel copper mug
taza
gobelet



Edelstahlbecher, Kupfer-Look
stainless steel cup, copper look
taza de acero inoxidable, cobre
gobelet en acier inox, cuivre

	Ø cm	↑ cm	ltr.	Farbe / Colour	€
93334	9	19,0	0,5	copper	19,90



Becher „PINEAPPLE“

barrel mug
taza
gobelet



Edelstahlbecher, Gold-Look
stainless steel cup, gold look
taza de acero inoxidable, dorada
gobelet en acier inox, doré

	Ø cm	↑ cm	ltr.	Farbe / Colour	€
93335	9	19,0	0,5	gold	19,90



Shaker „CLASSIC“

shaker
coctelera
shaker



Edelstahlbecher
stainless steel cup
taza de acero inoxidable
gobelet en acier inox

	Ø cm	↑ cm	ltr.	Farbe / Colour	€
93366 NEW	9,0	23	0,7		19,90
93326	9,0	23	0,7		19,00



Shaker „CLASSIC“

shaker
coctelera
shaker



Edelstahlbecher, Kupfer-Look, glänzend
stainless steel cup, copper look, highshine
taza de acero inoxidable, cobre, brillante
gobelet en acier inox, cuivre, brillant

	Ø cm	↑ cm	ltr.	Farbe / Colour	€
93211	8,5	20	0,5		15,50
93212	9,0	23	0,7		19,00



Shaker „CLASSIC“

shaker
coctelera
shaker



Edelstahlbecher, hochglanzpoliert
stainless steel cup, mirror polished finish
taza de acero, acabado pulido brillante
gobelet en acier, brillant

	Ø cm	↑ cm	ltr.	€
36010	8,5	20	0,5	13,50
36011	9,0	23	0,7	17,50



Parisian Shaker

shaker
coctelera
shaker



Edelstahlbecher, mattiert
stainless steel cup, satin polished finish
taza de acero, acabado efecto satinado
gobelet en acier, fini mat effet satin

	Ø cm	↑ cm	ltr.	€
93179	9,5	24	0,7	16,00



Boston Shaker

boston shaker
coctelera boston
shaker boston



2-teilig: Becher, 700 ml + Glas, 400 ml

2 pcs. set: beaker, 700 ml + glass, 400 ml

set de 2 piezas: vaso coctelero, 700 ml+ vaso vidrio 400 ml

2 pièces: bol mélangeur, 700 ml + bol en verre 400 ml

	Ø cm	↑ cm	ltr.	Farbe / Colour		€
93140	9	30	0,70 / 0,40		stainless-steel	13,00
93350 NEW	9	30	0,70 / 0,40		stainless-antique	14,00

	Ø cm	↑ cm	ltr.	Farbe / Colour		€
93325	9	30	0,70 / 0,40		copper-antique	14,00
93201	9	30	0,70 / 0,40		copper	14,00

Ersatzglas / spare glass / vaso de recambio / verre de rechange

	Ø cm	↑ cm	ltr.		€
93138	8,5	14,5	0,4		8,40



Boston Shaker

boston shaker
coctelera boston
shaker boston



2-teilig: Becher, 700 ml, gummiert, rutschfest + Glas, 400 ml

2 pcs. set: beaker, 700 ml, rubberized, anti-slip + glass, 400 ml

conjunto de 2 piezas: vaso coctelero con goma exterior 700 ml + vaso de vidrio 400 ml

2 pièces: bol mélangeur inox extérieur plastifié couleur 700 ml + bol en verre 400 ml

	Ø cm	↑ cm	ltr.	Farbe / Colour	€
93139	9	30	0,7		13,60

Ersatzglas / spare glass / vaso de recambio / verre de rechange

	Ø cm	↑ cm	ltr.		€
93138	8,5	14,5	0,4		8,40



Speed Shaker

boston shaker
coctelera boston
shaker boston



matt poliert, Größe oben Ø 8 cm, Größe unten Ø 6 cm

satin polished finish, size top Ø 8 cm, size bottom Ø 6 cm

pulido acabado satinado, arriba Ø 8 cm, medida abajo Ø 6 cm

poli mat satiné, Ø sup. 8 cm, Ø inf. 6 cm

	Ø cm	↑ cm	ltr.		€
36007	8	11,5	0,4		7,40

Bar . Café . Drinkware



Barmaß
jigger
medidor jigger
measure double jigger



	Ø cm	↑ cm	cl.	Farbe / Colour		€
93351	4,5	9	2 / 4		stainless-steel-polished	7,00



Barmaß
jigger
medidor jigger
measure double jigger



	Ø cm	↑ cm	cl.	Farbe / Colour		€
93354	4,5	9	2 / 4		stainless-antique	8,00



Barmaß
jigger
medidor jigger
measure double jigger



	Ø cm	↑ cm	cl.	Farbe / Colour		€
93353	4,5	9	2 / 4		copper	10,00



Barmaß
jigger
medidor jigger
measure double jigger



	Ø cm	↑ cm	cl.	Farbe / Colour		€
93352	4,5	9	2 / 4		copper-antique	10,00



Barmaß
jigger
medidor jigger
measure double jigger



	Ø cm	↑ cm	cl.	Farbe / Colour		€
93355	4,0	11	1,5 / 2,5 / 3,5 / 5		stainless-antique	9,00



Barmaß
jigger
medidor
measure double jigger



	Ø cm	↑ cm	cl.	Farbe / Colour		€
93164	4,5	9	2,5 / 5		stainless-steel-polished	8,00



Barmaß
jigger
medidor jigger
measure double jigger



	Ø cm	↑ cm	cl.	Farbe / Colour		€
93324	4	11	2,5 / 5		copper-antique	12,00



Barmaß
jigger
medidor jigger
measure double jigger



	Ø cm	↑ cm	cl.	Farbe / Colour		€
93165	4	11	2,5 / 5		copper	12,00



Barmaß
jigger
medidor jigger
mesure double jigger



hochglanzpoliert, schnelles und genaues Abmessen von Spirituosen
mirror polished finish, quick and exact measuring of spirits
pulido brillante, medida rápida y exacta de licores
poli miroir, mesure exact et rapide des spiritueux

	∅ cm	↑ cm	cl.	€
93356	5	9	1 / 1,5 / 2 / 3 / 4 / 6	12,00



Barmaß
jigger
medidor jigger
mesure double jigger



hochglanzpoliert, schnelles und genaues Abmessen von Spirituosen
mirror polished finish, quick and exact measuring of spirits
pulido brillante, medida rápida y exacta de licores
poli miroir, mesure exact et rapide des spiritueux

	∅ cm	↑ cm	cl.	€
93357	3,5	7,5	3 / 5	5,00



Barmaß
jigger
medidor jigger
mesure double jigger



	∅ cm	↑ cm	cl.	€
93121	4 / 3,5	8,5	2 / 4	5,00
93112	4,5 / 4	8,5	2,5 / 5	5,40



Barmaß
jigger
medidor jigger
mesure double jigger



	∅ cm	↑ cm	cl.	€
93120	4,5 / 3,5	7,0	2 / 4	4,60



Barmaß
jigger
medidor jigger
mesure double jigger



hochglanzpoliert, schnelles und genaues Abmessen von Spirituosen
mirror polished finish, quick and exact measuring of spirits
pulido brillante, medida rápida y exacta de licores
poli miroir, mesure exact et rapide des spiritueux

	∅ cm	↑ cm	cl.	€
93116	6 / 5	6	2 / 4	4,20

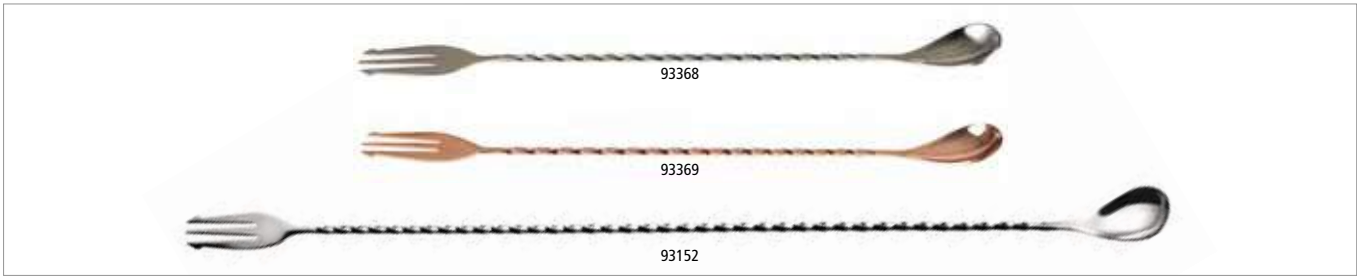

Barlöffel / -gabel
bar spoon
cucharilla de cóctel trident
cuillère de bar trident



	→ cm	Farbe / Colour		€
93368 <small>NEW</small>	30		stainless steel	6,00
93369 <small>NEW</small>	30		copper	9,00
93152	50		stainless steel	7,20

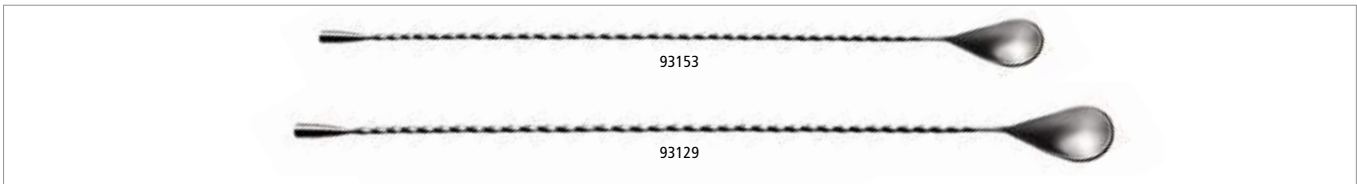

Barlöffel
bar spoon
cucharilla de cóctel
cuillère à cocktail



	→ cm	€
93153	40	4,90
93129	44	8,80

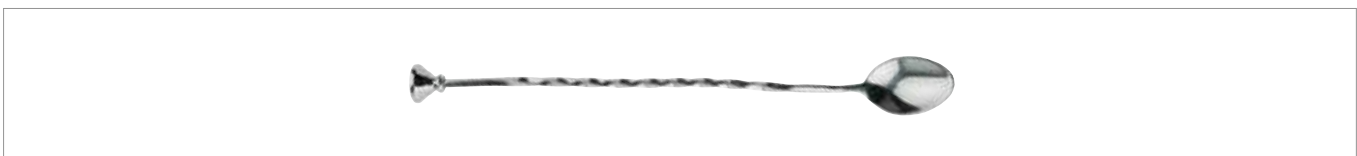

Barlöffel
bar spoon
cucharilla de cóctel
cuillère à cocktail



	→ cm	€
93134	27	4,80



Barlöffel
bar spoon
cucharilla de cóctel
cuillère à cocktail



	→ cm	Farbe / Colour		€
93034	27		copper	8,00



Barsieb

bar strainer
colador de cóctel
tamis cocktail



Spiralfeder hält Eiswürfel beim Abseihen zurück, Feder kann zur Reinigung entnommen werden, passend für alle Gläser und Shaker

coil spring keeps ice cubes in shaker, spring can be taken off for cleaning, suitable for all glasses and shakers

con muelle para mantener los cubitos en la coctelera, el muelle se desmonta para limpiar, se adapta a todos los tipos de vasos y cocteleras

avec ressort pour garder les glaçons dans le shaker, ressort démontable pour lavage, s'adapte à tous types de verres mélangeurs et shakers

	Ø cm	→ cm	Farbe / Colour	€
93347	9	Griff / handle 9	copper-antique	12,00
93348	9	Griff / handle 9	copper	12,00
93349	9	Griff / handle 9	stainless-antique	12,00
93312	9	Griff / handle 9	stainless	10,50



Einhandgebrauch
single-handed use



Julep Barsieb „PRO“

julep strainer
colador de cóctel
tamis cocktail



hochglanzpoliert
mirror polished finish
acabado pulido brillante
fini poli brillant

Einhandgebrauch
handed use

	Ø cm	→ cm	€
93313	7,5	Griff / handle 9	8,60



Barsieb

bar strainer
colador de cóctel
tamis cocktail



hochglanzpoliert, Spiralfeder hält Eiswürfel beim Abseihen zurück, Feder kann zur Reinigung entnommen werden, passend für alle Gläser und Shaker

mirror polished finish, coil spring keeps ice cubes in shaker, spring can be taken off for cleaning, suitable for all glasses and shakers

con muelle para mantener los cubitos en la coctelera, el muelle se desmonta para limpiar, se adapta a todos los tipos de vasos y cocteleras

brillant, avec ressort pour garder les glaçons dans le shaker, ressort démontable pour lavage, s'adapte à tous types de verres mélangeurs et shakers

	Ø cm	→ cm	→ Ø cm	€
93300	8,0	Griff / handle 6	mit Auflage-Örchen 12	5,00



Julep Barsieb „SIMPLE“

julep strainer
colador de cóctel
tamis cocktail



	Ø cm	→ cm	€
93305	8,0	Griff / handle 7,5	2,40



Barsieb

bar strainer
colador de cóctel
tamis cocktail



	Ø cm	→ cm	€
93318	8,5	11,5	3,50



Cocktailmesser

bar knife
cuchillo para cóctel
couteau cocktail



mit 2 Zinken zum Aufspießen von Zitrusseiben
with 2 prongs to pick up slices of lemon
con 2 dientes para pinchar las rodajas de limón, etc.
avec 2 dents pour les rondelles de citron et autres décorations

	→ cm	€
88846	21	3,80



Schneidebrett „BAR“

cutting board
table de corte
planche à découper



HDPE, mit Safrinne, mit Antirutsch-Füßchen
HDPE, with juice groove and non-slip feet
HDPE, con ranura para líquidos y pies antideslizantes
HDPE, avec rigole et pieds antidérapants

	cm	↑ cm	€
93306	30 x 20	2	27,00
93307	50 x 30	2	36,00



Zitruspresse

citrus squeezer
exprimidor cítricos
presse-citron



hochglanzpoliert, 2-teilig
mirror polished finish, 2 pcs.
pulido brillante, 2 piezas
brillant, 2 pièces

	Ø cm	↑ cm	ltr.	€
71431	12 / 17	10,5	0,35	12,90



2 Pressringe für Zitrone und Limette

Limetten- / Zitronenpresse

lime- / lemonpress
 exprimidor de limón / lima
 presse citron



	cm	↑ cm	€
93214	21 x 7	5	13,00



Limettenpresse

lime press
 prensa de limón
 presse citron



	cm	↑ cm	€
93189	21 x 7	5	10,00



Durch einfachen
 Druck leichte
 Teilung der
 Zitrus!

Zitrussteiler

citrus wedger
 cortador de cítricos
 coupe-agrumes



mit Antirutsch-Füßchen, 2-teilig, Griffelement zur sicheren Bedienung mit innenliegendem Schneidmesser, teilt Zitrusfrüchte in Achtel, leicht unter fließendem Wasser zu reinigen

with non-slip feet, 2 pieces, handle for safe use and with internal cutting knife, cut citrus fruits in eight pieces, easy to clean with water
 con pies antideslizantes, 2 piezas, asas para un uso seguro y con cuchillas internas, divide los cítricos en ocho partes, fácil de limpiar con agua
 pieds antiglisses, 2 pièces, anses pour une usage sûr avec des lames internes, divise les agrumes en huit pièces, facile à nettoyer avec de l'eau

	cm	↑ cm	€
93317	20 x 15	19	60,00



Stößel
muddler
mortero
pilon muddler



mit griffigem Ende, zum Auspressen von Früchten und Zerstoßen von Würfelzucker
with handy end, to press fruits or pound lump sugar
con un acabado en relieve para exprimir frutas y machacar azucarillos
avec relief grillagé pour presser les fruits ou le sucre en morceaux

	Ø cm	→ cm	Farbe / Colour	€
93358	3,5	20,5		6,90
93360	3,5	20,5		9,00
93361	3,5	20,5		9,00



Stößel „BIG“
muddler
mortero
pilon muddler



POM mit Edelstahl-Kappe, flacher, glatter Stößel, zum Auspressen von Früchten und Zerstoßen von Würfelzucker
flat surface, to press fruits or pound lump sugar
superficie lisa para exprimir frutas y machacar azucarillos
muddler grand format avec bout lisse pour presser les fruits ou le sucre en morceaux

	Ø cm	→ cm	Farbe / Colour	€
93183	4,5	25		14,90



Stößel
muddler
mortero
pilon muddler



grober Stößel, zum Auspressen von Früchten und Zerstoßen von Würfelzucker
coarse notched, to press fruits or pound lump sugar
mortero grueso con muescas para exprimir frutas y machacar azucarillos
muddler grand format avec bout relief étoile pour presser les fruits ou le sucre en morceaux

	Ø cm	→ cm	Farbe / Colour	€
93182	4	24		7,00



Stößel
muddler
mortero
pilon muddler



mit griffigem Ende, zum Auspressen von Früchten und Zerstoßen von Würfelzucker
with handy end, to press fruits or pound lump sugar
acabado relieve para prensar frutas o azucar
avec relief grillagé pour presser les fruits ou le sucre en morceaux

	Ø cm	→ cm	Farbe / Colour	€
93180	2,5	21		3,30
93181	2,5	21		3,30





Eiseimer-Set mit Eiszange

ice bucket set with tong
cubitera isotérmica
seau à glaçons isothermique

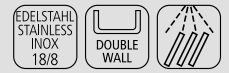

Deckel hochglanzpoliert, Behälter matt poliert, inkl. Edelstahl-Eiszange
cover mirror polished finish, container satin polished finish, incl. stainless steel tong
tapa pulida efecto brillante, con doble pared, con pinza de hielo
couverture brillante, double paroi, avec pince à glaçons

	Ø cm	↑ cm	ltr.	€
36013	12	14	1	29,00



Eiseimer-Set mit Eiszange

ice bucket set with tong
cubitera clásica con pinza
seau à glaçons classique avec pince



weißer Kunststoffmantel, Kunststoff-Tragebügel, spezial isolierter
Kunststoffeinsatz sorgt für beste Kühlung, Kunststoffdeckel klar, inkl. Eiszange

white plastic jacket, plastic handle, special insulated plastic insert,
for best cooling, transparent plastic cover, incl. tong
cubitera blanca, asa de plástico blanco, interior aislante
especial con tapa transparente, con pinza

seau à glaçons, anse en plastique blanc, paroi intérieure
spécialement isolante, couvercle transparent, avec pince

	Ø cm	↑ cm	ltr.	€
36027	15	15	1,5	16,90
36029	20	18	3	23,00



Eiseimer-Set mit Eiszange

ice bucket set with tong
cubitera clásica con pinza
seau à glaçons classique avec pince



edler Kunststoffmantel in matt-metall Optik, Rand hochglanzpoliert, Tragebügel transparent,
spezial isolierter Kunststoffeinsatz sorgt für beste Kühlung, Kunststoffdeckel klar

noble plastic jacket in satin metal look, with mirror polished finish edge, handle transparent,
special insulated plastic insert, transparent plastic cover

plástico aspecto metálico satinado, borde brillante, asa transparente, interior plástico aislante
especial, tapa de plástico transparente

plastique aspect métal satiné, bord brillant, anse transparente, paroi intérieure spécialement
isolante, couvercle transparent

	Ø cm	↑ cm	ltr.	€
36022	15	15	1,5	20,00
36024	20	18	3	23,50



Eiseimer-Set mit Eiszange

ice bucket set with tong
cubitera clásica con pinza
seau à glaçons classique avec pince



hochglanzpoliert, edler Kunststoffmantel, inkl. Edelstahl-Eiszange und
Abtropfgitter mit Tragebügel, spezial isolierter Kunststoffeinsatz sorgt für beste Kühlung

mirror polished finish, noble plastic jacket, highly plated, incl. stainless steel
tong and drainer, with handle, special insulated plastic insert for best cooling

exterior de plástico de alta calidad de aspecto metálico mate,
incluye pinza de inox, plástico interior aislante especial

plastique aspect métal brillant, bonne qualité, avec pince inox
et égouttoir, paroi intérieure spécialement isolante

	Ø cm	↑ cm	ltr.	€
36015	14	22	1,3	24,00



5 Liter

Eisbox
ice box
cubitera
seau à glaçons



Aluminium eloxiert
aluminium anodised
aluminio anodizado
aluminium anodisé

	Ø cm	↑ cm	ltr.	€
36033	18,5	20	5	38,00



8 Liter

Eisbox
ice box
cubitera
seau à glaçons



Aluminium eloxiert
aluminium anodised
aluminio anodizado
aluminium anodisé

	Ø cm	↑ cm	ltr.	€
36037	27	20	8	49,00



Eisbox
icebox
cubitera
seau à glaçons



mit herausnehmbarem Tropfeinsatz
with drainer
plástico interior aislante especial
égouttoir

	cm	↑ cm	ltr.	€
93220	27 x 27	15	5,4	41,00



Eisbox
icebox
cubitera
seau à glaçons



mit herausnehmbarem Tropfeinsatz
with drainer
plástico interior aislante especial
égouttoir

	cm	↑ cm	ltr.	€
93200	20 x 20	17	3,4	28,00



Ø 5,5 cm

Eis-Kugel-Former

ice ball former
molde de cubitos de hielo esféricos
moule à glaçons en boules



2 tlg., 3 Kugeln à 100 ml, einfach mit Wasser füllen und gefrieren lassen

3 bowls à 100 ml, simply fill with water and allow to freeze
3 bolas de 100 ml, simplemente llenar con agua y dejar congelar
3 boules à 100 ml, simplement remplir avec de l'eau et mettre à congeler

	cm	↑ cm	€
12990	23,5 x 8,5	6,5	9,90



Eiszerkleinerer

Ice crusher
picadora de hielo
broyeur à glaçons



glasklar, mit Edelstahl-Messer

clear, stainless steel cutters
cuchillas de acero inoxidable
couteaux inox

	cm	↑ cm	€
36017	12 x 12	24	15,00



Eiszange

ice tong
pinza para cubitos de hielo
pince à glaçons



matt poliert, mit griffigem Ende, ideal für Eiswürfel und Obstscheiben

satin polished finish, with handy end, ideal for ice cubes and fruit slices
pulido satinado, forma ergonómica ideal para cubitos de hielo y láminas de fruta
poli mat satiné, forme ergonomique idéale pour glaçons et fruits tranchés

	cm	→ cm	€
93190	2 x 1,5	20	5,80



hot price

Eiszange

ice cube tong
pinza para cubitos de hielo
pince à glaçons



hochglanzpoliert, fugenlos

mirror polished finish, seamless
pulido acabado brillante, de una sola pieza
brillant, d'une seule pièce

	cm	→ cm	€
75805	5 x 2	17,5	2,00



Eisschaufel
ice scoop
pala de hielo
pelle à glaçons



	cm	→ cm	ltr.	€
93192	10 x 6	29	0,7	7,80



Eisschaufel
ice scoop
pala de hielo
pelle à glaçons



geloht, ideal zum Befüllen von schlanken Gläsern, Schmelzwasser fließt zurück in die Eisbox
perforated, ideal to fill narrow glasses, melt water flews back into the ice box
perforada, ideal para llenar vasos estrechos, el agua derretida cae en la caja de hielo
perforée, idéale pour verser les glaçons dans des verres étroits, l'eau retombe dans le bac à glaçons

	Ø cm	→ cm	€
93191	5	19	6,50



Eiszerkleinerer
ice crusher
pickadora de hielo
broyeur à glaçons



	Ø cm	→ cm	€
93193	2	19,5	3,50



Eiszerkleinerer
ice crusher
pickadora de hielo
broyeur à glaçons



	cm	→ cm	€
93194	6,5 x 2,0	23,0	6,90



Glasumrand
glass rimmer
ribeteador de vasos
bordeur à verres „rimmer“



Schwamm für Limettensaft, 2 Fächer für Zucker und Salz
with sponge for lime juice, 2 cases for sugar and salt
con esponja para zumo de lima, 2 compartimentos para azucar y sal
avec éponge et 2 compartiments pour sucre et sel

	cm	Farbe / Colour	€
93175	20 x 7,5	■	9,00

Bar . Café . Drinkware



Trinkhalme 11er Set

straws, 11 pcs.set
pajas, set de 11 pz.
pailles, set de 11 pc.



11-teiliges Set: 10 Trinkhalme aus Edelstahl + Reinigungsbürste

11 pcs. set: 10 drinking straws made of stainless steel + cleaning brush
set de 2: 10 pajas de acero inoxidable + cepillo de limpieza
set de 2: 10 pailles en acier inox + brosse de nettoyage

	Ø mm	→ cm	Farbe / Colour	€/Set
93380	6	21,5	copper-look	12,00
93381	6	21,5	gunmetal-look	12,00
93382	6	21,5	rainbow-look	12,00
93383	8	21,5	copper-look	13,00
93384	8	21,5	gunmetal-look	13,00
93385	8	21,5	rainbow-look	13,00

Ersatzbürste / replacement brush / cepillo de recambio / brosse de rechange

	Ø mm	→ cm	€/Set
93386	8	20	2,40



Trinkhalme 7er Set

straws, 7 pcs.set
pajas, set de 7 pz.
pailles, set de 7 pc.



	Ø mm	→ cm	pcs.	€/Set
93390	10	21	7	18,00



Rührglas mit Lippe

mixing glass with lip
vaso mezclador vertedor con pico
verre mélangeur avec bec verseur



schwere Qualität

heavy quality
alta calidad
qualité renforcée

	Ø cm	↑ cm	ltr.	VE	€
93101	11,5	19	1	12	10,00



Pitcher

pitcher
jarra
pichet



	Ø cm	↑ cm	ltr.	€
93105	13	21	1,5	8,40



1:1 Oberflächenansicht
1:1 structural view

Rührglas mit Lippe

mixing glass with lip
vaso mezclador vertedor con pico
verre mélangeur avec bec verseur



	Ø cm	↑ cm	ltr.	€
93141	9	16	0,50	10,00

CONFERENCE



Flaschenkühler „CONFERENCE“

conference bottle cooler
enfriador múltiple
rafraîchisseur



inkl. Kühlakku, Flaschenöffner, Kronkorkenschale, mit 6 Öffnungen Ø 6,7 cm für 0,25 - 0,5 Liter-Flaschen

incl. bottle cooler, bottle opener, small cap bowl, with 6 holes Ø 6,7 cm for 0,25 to 0,5 liter bottles

con acumulador de frío, abridor, recuperador de chapas, 6 plazas Ø 6,7 cm, para botellas de 25 a 50 cl

avec accumulateur de froid, décapsuleur, bol récupérateur de capsules, 6 places Ø 6,7 cm, pour bouteilles de 25 à 50 cl

	Ø cm	↑ cm	Farbe / Colour	€
00620	23	15	White	46,00
00621	23	15	Black	46,00



Kühlakku

cooler
acumulador de frío
accumulateur de froid

	Ø cm	→ cm	Farbe / Colour	€
00616	7,5	11,5	White	10,00
00615	7,5	11,5	Black	10,00



Flaschenöffner

bottle opener
abridor
décapsuleur



	Ø cm	→ cm	€
00617	1	13,5	5,10



Kronkorkenschale

cap bowl
cuenco para chapas
bol récupérateur de capsules



	Ø cm	↑ cm	Farbe / Colour	€
00618	6,5	3	White	2,10
00619	6,5	3	Black	2,10

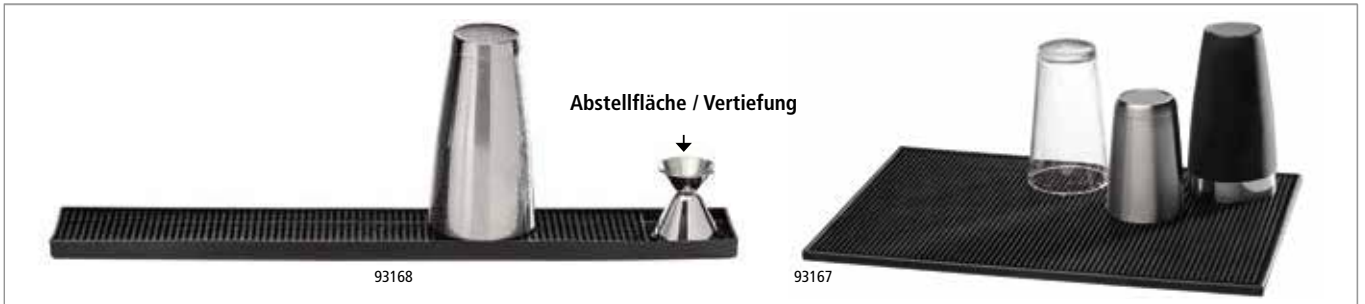

Barmatte
drip mat
tapete escurridor
tapis de bar



aus weichem Kunststoff, zum Abtropfen von Gläsern etc.
soft plastic, to store and drain glasses
plástico blando para escurrir vasos
plastique souple, pour l'égouttage des verres

	cm	↑ cm	Farbe / Colour		€
93166	30 x 15	1	■	ohne Vertiefung	6,50
93167	45 x 31	1	■	ohne Vertiefung	18,00
93173	52 x 8	1	■	ohne Vertiefung	7,80
93168	60 x 8	1	■	mit Vertiefung	8,50
93169	60 x 8	1	■	ohne Vertiefung	8,50



Abtropfmatte
drip mat
esterilla escurridora
tapis égouttoir



gerollt
rolled
enrollada
roulée

	cm	↑ cm	Farbe / Colour	€
93314	60 x 300	0,3	■	16,00
93315	60 x 300	0,3	■	16,00

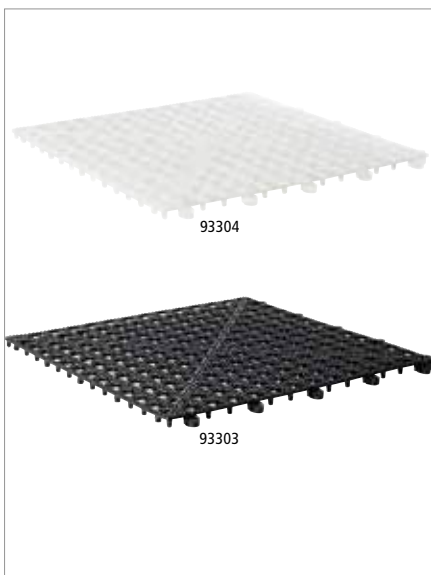

Abtropfmatte
drip mat
esterilla escurridora
tapis égouttoir



erweiterbar durch Klick-Verbindung
expandable
las placas de fijan con clips
avec clips de fixation

	cm	↑ cm	Farbe / Colour	€
93304	33 x 33	1,5	■	4,90
93303	33 x 33	1,5	■	4,90





Zutatenbehälter
condiment holder
dispensador de especias
boîte à fruits et ingrédients



500 ml Inhalt pro Fach, 6 Fächer, inkl. Deckel (gefrostet) zur Lagerung
6 chambers á 50 ml, incl. lid for storing
6 compartimentos de 50 ml., incluye tapa para el almacenaje
6 compartiments de 50 ml chacun, avec couvercle pour le stockage

	cm	↑ cm	€
93171	50 x 16	10	19,00



Bar-Caddy
bar caddy
organizador de bar
organisateur „bar caddy“



Ordnungshilfe für Trinkhalme, Rührer, Servietten, Streichhölzer, etc.
to organize straws, stirrers, napkins, matches, etc.
para organizar pajitas, cucharillas, servilletas, cerillas, etc.
pour bien organiser les pailles, agitateurs, cuillers, serviettes et autres accessoires

	cm	↑ cm	€
93174	24 x 15	11	7,00



Getränkspender „OLD FASHIONED“
drinks dispenser
dispensador de bebidas
distributeur de boissons



dicke, stabile Wände, weite Öffnung für große Zutaten, Gestell schwarz
thick, stable walls, a wide opening for large ingredients, black stand
tiene paredes gruesas y estables, amplia abertura para ingredientes grandes, soporte negro
des murs épais et stables, large ouverture pour de grands ingrédients, support noir

	Ø cm	↑ cm	ltr.	€
10409	24,5	50,5	7	inkl. Gestell / incl. stand 49,00



Getränkspender „FRUITS“
drinks dispenser
dispensador de bebidas
distributeur de boissons



dicke, stabile Wände, weite Öffnung für große Zutaten, Gestell schwarz
thick, stable walls, a wide opening for large ingredients, black stand
tiene paredes gruesas y estables, amplia abertura para ingredientes grandes, soporte negro
des murs épais et stables, large ouverture pour de grands ingrédients, support noir

	Ø cm	↑ cm	ltr.	€
10415	25	58	10,5	inkl. Gestell / incl. stand 69,00



Kellner-Flaschenöffner

waiter's barblade
abridor camarero
décapsuleur



matt poliert
satin polished finish
pulido acabado mate
poli mat

	cm	€
93122	18 x 4	3,40



Kellner-Flaschenöffner

waiter's barblade
abridor camarero
décapsuleur



mit Gummierung
with rubber coating
con revestimiento de goma
avec revêtement en caoutchouc

	cm	€
93125	11 x 4	3,90



Kronkorkenöffner

bottle cap opener
abridor de chapas de pared
décapsuleur mural



für die Wandmontage, aus massivem Metall
for wall fastening, massive metal
para fijación en la pared, metal macizo
massif, à fixer au mur

	cm	↑ cm	€
93124	7 x 8	3	9,90



Kronkorken-Sammelbehälter

bottle cap holder
recogedor de chapas
bac récupérateur de capsules



matt poliert, für die Wandmontage unterhalb des Kronkorkenöffners
satin polished finish, for wall fastening beyond the opener
para fijar en la pared debajo del abridor, para recoger las chapas
à fixer au mur sous le décapsuleur mural

	cm	↑ cm	€
93172	13,5 x 8	24	15,00

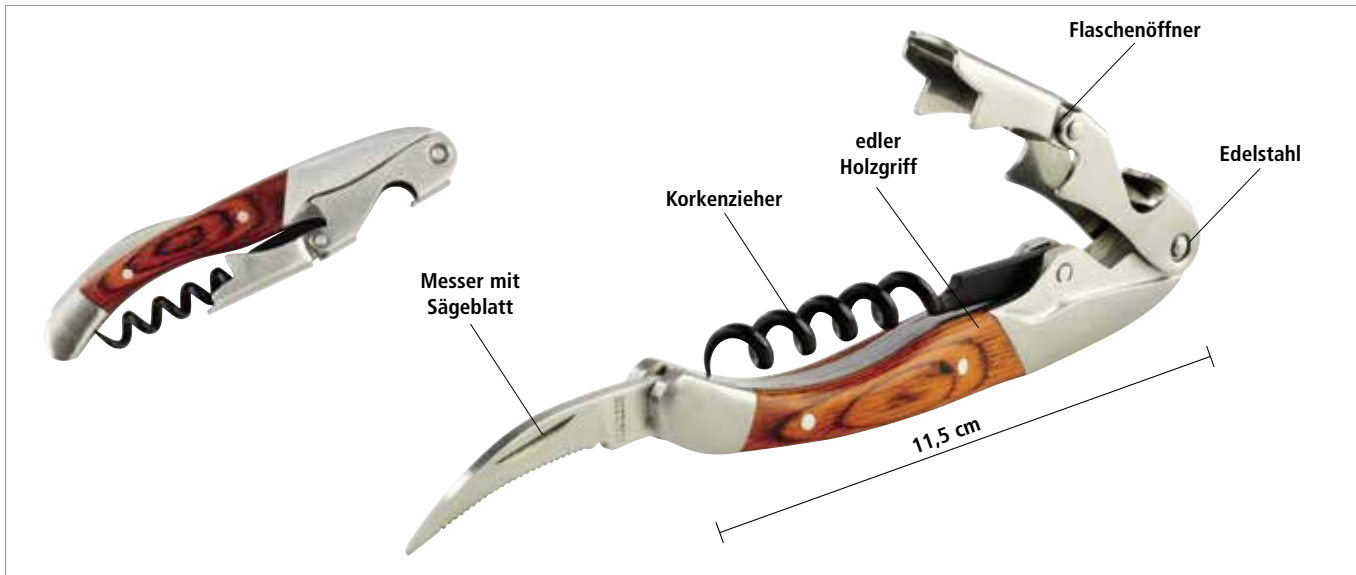

Kellnermesser „PROFI“

waiter's corkscrew
sacacorchos de camarero
tire-bouchons



leichtgängige Teflon-Spirale, mehrstufige Klapphebelfunktion, am Kopf angebrachtes Messer
easy moving teflon coil, 2-stage opening system, knife at the top end
mecha de teflón, sistema de apertura en 2 golpes, con cuchillo en la parte superior
mèche téflon, ouverture en 2 étapes, couteau dans la partie supérieure

	→ cm	€
93302	11,5	9,90



Kellnermesser

waiter's corkscrew
sacacorchos de camarero
tire-bouchons



leichtgängige Teflon-Spirale, mehrstufige Klapphebelfunktion, am Kopf angebrachtes Messer
easy moving teflon coil, 2-stage opening system, knife at the top end
mecha de teflón, sistema de apertura en 2 golpes, con cuchilla en la parte superior
mèche téflon, ouverture en 2 étapes, couteau dans la partie supérieure

	→ cm	€
93301	12	4,80

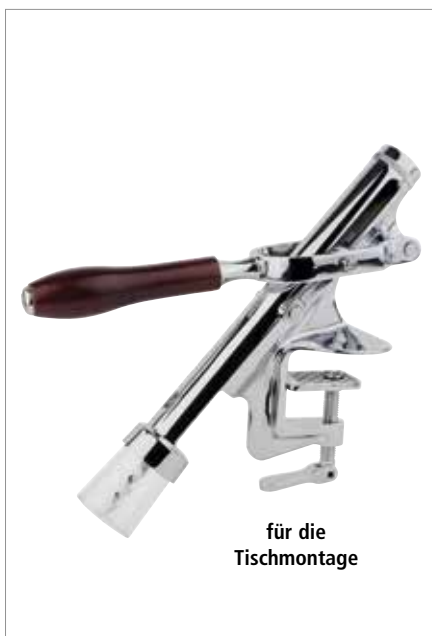

Korkenzieher

corkscrew
sacacorchos
tire-bouchons



durch die ausgefeilte Technik und den großen Holzhebel lässt sich eine Weinflasche mühelos mit zwei schnellen Bewegungen öffnen, schwere Profi-Qualität, Grifflänge 13,5 cm
a wine bottle can easily be opened with two quick actions due to the sophisticated technique and the large wooden lever, heavy professional quality, handle length 13,5 cm
para profesionales de la gastronomía y del vino, una botella se abre fácilmente con sólo dos gestos, gracias a un eficaz mecanismo y a una palanca de 13,5 cm, alta calidad profesional
une bouteille s'ouvre simplement en 2 gestes avec son mécanisme sophistiqué et pratique, avec un levier de 13,5 cm, pour les professionnels de la gastronomie et du vin

	→ cm	€
93299	53	48,00



Dosier- & Vorratsflasche

pouring container
botella „store & pour“
bouteille „store & pour“



4-teilig: Behälter + Flaschenhals + Schraubdeckel + Ausgießer Ø 11 mm mit Luftzufuhr für gezieltes Ausgießen, zum Dosieren und Aufbewahren

4 pcs. set: for storage, mixing and serving drinks, nozzle Ø 11 mm

set de 4 piezas: para almacenar y servir mezclas y bebidas, agujero de Ø 11 mm

se compose de 4 pièces: idéal pour servir et pour conserver les boissons, embout Ø 11 mm

	Ø cm	↑ cm	ltr.	Farbe / Colour	€
93144	9	33	0,85		4,60
93145	9	33	0,85		4,60
93146	9	33	0,85		4,60
93147	9	33	0,85		4,60
93148	9	33	0,85		4,60
93149	9	33	0,85		4,60



abnehmbarer Boden dient als Deckel
removable bottom serves as a lid



Dosier- & Vorratsflasche

pouring container
botella „store & pour“
bouteille „store & pour“



4-teilig: Behälter + Flaschenhals + Schraubdeckel + Ausgießer Ø 11 mm mit Luftzufuhr für gezieltes Ausgießen, zum Dosieren und Aufbewahren

4 pcs. set: for storage, mixing and serving drinks, nozzle Ø 11 mm

set de 4 piezas: para almacenar y servir mezclas y bebidas, agujero de Ø 11 mm

se compose de 4 pièces: idéal pour servir et pour conserver les boissons, embout Ø 11 mm

	Ø cm	↑ cm	ltr.	Farbe / Colour	€
93143	9	33	0,85		6,90

abnehmbarer Boden dient als Deckel
removable bottom serves as a lid



Dosier- & Vorratsflasche

pouring container
botella „store & pour“
bouteille „store & pour“



4-teilig: Behälter + Flaschenhals + Schraubdeckel + Ausgießer mit Luftzufuhr für gezieltes Ausgießen, zum Dosieren und Aufbewahren

4 pcs. set: for storage, mixing and serving drinks

set de 4 piezas: para almacenar y servir mezclas y bebidas

se compose de 4 pièces: idéal pour servir et pour conserver les boissons

	Ø cm	↑ cm	ltr.	Farbe / Colour	€
94144	12,5	35	1,9		6,20
94145	12,5	35	1,9		6,20
94146	12,5	35	1,9		6,20
94147	12,5	35	1,9		6,20
94148	12,5	35	1,9		6,20
94149	12,5	35	1,9		6,20



abnehmbarer Boden dient als Deckel
removable bottom serves as a lid



Spritzflasche inklusive Ausgießer
 squeeze bottle with nozzle
 botella exprimible con dosificador
 flacon pulvérisateur avec bec verseur



ideal für Bitter-Liköre, Essig, Öl
 perfect for bitter liqueur, vinegar, oil
 perfecto para amargo licor, vinagre, aceite
 pour amaro liquore, vinaigre, huile

	cm	↑ cm	ltr.	€
93308	6 x 5	20	0,2	9,00

Ausgießer passend für Spritzflasche / nozzle suitable for squeeze bottle / dosificador apto para botella exprimible / bec verseur approprié pour flacon pulvérisateur

	Ø cm	↑ cm	€
93309	2,5	5,5	2,60

Abbildung in Originalgröße
 illustration original size

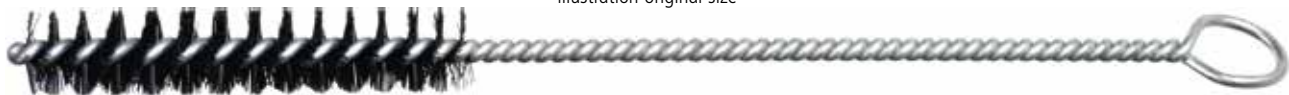

Reinigungsbürste für Ausgießer
 pourer cleaning brush
 cepillo de limpieza para picos vertedores
 brosse lave-bouchons doseurs



	→ cm	€
93102	16,5	2,50



Permanent-Ausgießer, 6er Set
 free flow pourer, 6 pcs. set
 vertedor continuos set 6 piezas
 set de 6 bouchons verseurs continus



à 2 Stück: blau, rot, gelb
 2 pcs of each colour: blue, red, yellow
 2 piezas de cada color: azul, rojo, amarillo
 2 par couleur: bleu, rouge, jaune

	Ø cm	↑ cm	pcs.	€
93111	3	7,5	6	4,50



Permanent-Ausgießer, 6er Set
 free flow pourer, 6 pcs. set
 vertedor continuos set 6 piezas
 set de 6 bouchons verseurs continus



	↑ cm	pcs.	€
93110	11	6	11,90



Ausgießer, 2er Set
 pourers, 2 pcs. set
 vertedores set 2 piezas
 set de 2 bouchons verseurs



Portionierer 2 cl, schnelles und genaues Abmessen
 2 cl, quick and exact measuring
 2 cl. medición rápida exacta
 2 cl mesure exacte et rapide

	↑ cm	pcs.	€
93115	10	2	13,00



Permanent-Ausgießer, 6er Set
 free flow pourer, 6 pcs. set
 vertedor continuos set 6 piezas
 set de 6 bouchons verseurs continus



	↑ cm	pcs.	€
93114	8	6	11,00



Ausgießer „STEADY SPOUT“, 2er Set
 pourers, 2pcs. set
 vertedores set 2 piezas
 set de 2 bouchons verseurs



Konstanter Durchfluss ohne Spritzer beim An- oder Absetzen durch patentierte Technologie, Ausgießer verfügt über unterschiedlich große Lamellen, die auf Flaschen mit einem Innendurchmesser von 18 bis 21,5 mm eingesetzt werden können. Nach Reinigung mit Warmwasser springt der Korken in die Ausgangsform zurück (Memory-Effekt).

Due to the patented technology you will have a constant flow and no splashing when turning and tipping the bottle, spout has different sizes of slats, which can be used on bottles with an internal diameter of 18 to 21,5 mm. After cleaning with hot water, the cork will return in its original shape (memory effect).

Gracias a la tecnología patentada el flujo es constante sin salpicar al servir, el surtidor ofrece listones de diferentes tamaños, que pueden ser utilizados en botellas con un diámetro interno de 18 a 21,5 mm. Después de la limpieza con agua caliente el corcho salta a su forma original (efecto memoria).

Grâce à la technologie brevetée le débit est constant sans éclaboussures lors du démarrage ou de l'arrêt, le bec offre lattes de tailles différentes, qui peuvent être utilisés sur les bouteilles d'un diamètre intérieur de 18 à 21,5 mm. Après avoir nettoyé à l'eau chaude, le bouchon en liège saute à sa forme originale (effet mémoire).

	↑ cm	pcs.	€
93319	10,5	2	6,40



Champagner-Verschluss

champagne saver
tapón vertedor
bouchon verseur



patentierter "Pull Down Bottle Grip", passt auf fast alle Standard Champagner- o. Sektflaschen
patented "Pull Down Bottle Grip", fits most champagne bottles
patentado, apto para la mayoría de botellas de cava o champagne
modèle déposé, apte pour la plupart de bouteilles de champagne

	cm	↑ cm	€
93135	5 x 5	8	12,00



Champagner- / Sektkonservator

champagne conservator
tapón conservador
bouchon de conservation



2-teilig: Überdruckpumpe + luftdichter Bügelverschluss mit Entlüftungsventil, Champagner und Sekt lassen sich nach dem Öffnen für längere Zeit frisch halten

2 pcs. set: overpressure pump + airtight swing-top with air valve, opened champagne and sparkling wine can be kept fresh for a longer time

set de 2 piezas: bomba a presión + tapón swing hermético con válvula de aire acero inox y plástico, el cava y las bebidas espumosas pueden conservarse y mantenerse por más tiempo.

set de 2 pièces: bombe à pression + bouchon swing hermétique avec valve - inox et plastique - enfin un moyen de conserver plus longtemps le champagne et autres vins mousseux

	Ø cm	↑ cm	Farbe / Colour	€
93126	4,5	12	■	23,00

Verschluss einzeln / stopper single / tapón individual / bouchon seul

	€
93127	12,60



Sekt-Verschluss, 2er Set

stopper, 2 pcs. set
set de 2 taponos
set de 2 bouchons



matt poliert, innen Gummi Arabicum

satin polished finish, inside rubber arabicum, with inscription

acabado pulido mate, interior goma arábica con inscripción

poli mat satiné, intérieur gomme arabique

	Ø cm	↑ cm	pcs.	€
93160	4	5,5	2	8,20



Wein-Verschluss, 2er Set

wine stopper, 2 pcs. set
2 taponos para vino
2 bouchons pour le vin



matt poliert, innen Kunststoff, mit Schriftzug „WINE“

satin polished finish, inside plastic, with inscription „WINE“

acabado pulido mate, interior de plástico con inscripción „WINE“

poli mat satiné, intérieur plastique, avec inscription „WINE“

	Ø cm	↑ cm	pcs.	€
93206	4	4,5	2	8,00



Teller mit Glashalter „COCKTAIL“
 plate with glass holder
 plato sujeta copas
 assiette porte-verre

MF MELAMINE

eignet sich besonders für Stehempfänge, einhändig nutzbar
 particularly suitable for standing receptions, single-handed use
 para uso en recepciones de pie, facil de usar con sólo una mano
 particulièrement pour des receptions debout, utilisable avec une seule main

	→ cm	↑ cm	€
84620	22,0 x 14,0	1,5	3,00

	Ø cm	↑ cm	€
84621	19,0	1,5	3,00



84620



84621



Wein-Vakuumpumpe
 vacuum wine pump
 bomba de vacío para vino
 pompe à vide pour le vin

ABS KUNSTSTOFF **EDELSTAHL STAINLESS INOX**

inkl. 2 Stopfen, um offene Flaschen erneut zu versiegeln und den Wein zu konservieren
 incl. 2 stoppers, to reseal open wine bottles and conserve the wine
 incluye 2 tapones para cerrar perfectamente las botellas abiertas y conservar el vino
 livrée avec 2 bouchons pour refermer les bouteilles tout en conservant le vin parfaitement

	Ø cm	↑ cm	€
93123	3,5	15	17,90

Weinpumpe-Ersatzstopfen, 2er Set / wine pump stopper, 2 pcs. set / tapones al vacío para el vino / set de 2 bouchons à vide pour le vin

	Ø cm	↑ cm	pcs.	€
93162	3	4,5	2	4,60



Staubkappen, 2er Set
 dust & fly cap, 2 pcs. set
 tapón antipolvo
 bouchon anti-poussières et anti-insectes

ABS KUNSTSTOFF

schützt vor Staub und Insekten
 protects for dust and insects
 para proteger de la suciedad e insectos
 pour protéger de la poussière et des insectes

	Ø cm	↑ cm	pcs.	Farbe / Colour	€
93161	4	8	2	■	4,20



Schlüsselschnur, 2er Set
 key cord, 2 pcs. set
 llavero enrollable
 porte-clés avec cable à enroulement

ABS KUNSTSTOFF **METALL** **EDELSTAHL STAINLESS INOX**

Schnur 65 cm lang, Befestigung mit Klammer am Gürtel, starke Rückzugfeder
 65 cm long cord, to fix at waistbelt, strong pull-back spring
 65 cm longitud del cable para fijar en una hebilla, cable enrollable automático con muelle
 longueur 65 cm, à fixer à la ceinture, enroulage automatique

	Ø cm	↑ cm	€
93170	4	2	7,00



Multistreuer
multi-functional shaker
salero
saupoudreuse



	Ø cm	↑ cm	ltr.	€
00774	7	12	0,20	12,00



geschlossen Ø 2 mm Ø 4 mm Ø 6 mm



Multistreuer
multi-functional shaker
salero
saupoudreuse



	Ø cm	↑ cm	ltr.	€
00773	6	8	0,05	8,00



geschlossen Ø 2 mm Ø 4 mm Ø 6 mm



Netzstreuer
mesh top shaker
polvoreador, tapa con malla fina
pot à épices, couvercle toile fine



	Ø cm	↑ cm	ltr.	€
00781	6,5	12	0,20	11,00



Multistreuer / Gewürzstreuer
multi-functional shaker
juego dosificador
jeu de salières



	Ø cm	↑ cm	ltr.	€
00782	6,5	12	0,20	10,00
00783	6,5	12	0,20	10,00

mit 8 Löchern / with 8 holes
con 8 agujeros / avec 8 trous



00782 00783



Allzweckgießer

pourer
bote vertedor universal
pot verseur universel



für Honig, Kaffeesahne, etc., Schraubdeckel aus Edelstahl

for honey, cream, etc., cover stainless steel

para miel, crema, etc., tapa inoxidable

pour le miel, le lait, la crème, etc., couvercle inox

	Ø cm	↑ cm	ltr.	€
00765	8,5	13,5	0,3	6,60

Ersatzglasbehälter / spare glas-container / contenedor de repuesto / récipient verre de rechange

	€
00768	1,80



Zuckerdosierer

sugar dispenser
azucarero
sucrier



Schraubdeckel aus Edelstahl

cover stainless steel

tapa inoxidable

couvercle inox

	Ø cm	↑ cm	ltr.	€
00766	8,5	15	0,3	3,50

Ersatzglasbehälter / spare glas-container / contenedor de repuesto / récipient verre de rechange

	€
00768	1,80



Zuckerdosierer

sugar dispenser
azucarero
sucrier



Schraubdeckel aus Edelstahl, mit Dosierrohr

cover stainless steel with dosingtube

tapa inoxidable y tubo dosificador

couvercle inox et tube doseur

	Ø cm	↑ cm	ltr.	€
40490	8,5	12	0,15	2,90
40494	8	15	0,25	2,90

Ersatzglasbehälter / spare glas-container / contenedor de repuesto / récipient verre de rechange

	fits to	€
40498	40490	1,60
40499	40494	1,60



250 ml

Allzweckgießer

pourer
dosificador
doseur



Schraubdeckel aus Edelstahl und Kunststoff, mit Dosierklappe

cover stainless steel and plastic, with dosing flap
acero inoxidable y tapa plástico, con cierre dosificador
couvercle en inox et plastique, avec couvercle doseur

	Ø cm	↑ cm	ltr.	€
40488	8	12,5	0,25	5,60



250 ml

Zuckerdosierer

sugar dispenser
azucarero
sucrier



Schraubdeckel aus Edelstahl, mit Dosierrohr

cover stainless steel, with dosing tube
tapa inoxidable y tubo, con cierre dosificador
couvercle inox et tube doseur

	Ø cm	↑ cm	ltr.	€
40486	8	15	0,25	2,90



320 ml

Zuckerdosierer

sugar dispenser
azucarero
sucrier



Schraubdeckel aus Edelstahl, mit Dosier-Rohr

cover stainless steel, with dosing tube
tapa inoxidable y tubo dosificador
couvercle inoxydable et tube doseur

	Ø cm	↑ cm	ltr.	€
40506	7,5	17,0	0,32	4,20



320 ml

Zuckerdosierer

sugar dispenser
azucarero
sucrier



Schraubdeckel mit Klappe aus Edelstahl, mit Dosierklappe

cover stainless steel, with dosing flap
tapa acero inoxidable, con cierre dosificador
couvercle inox, avec couvercle doseur

	Ø cm	↑ cm	ltr.	€
40487	7,5	13,5	0,32	3,60



0,3 ltr.

Teekanne „ASIA“

teapot
tetera
théière



aus Gusseisen, innen emailliert, hält den Tee lange warm,
kein nachbittern, ideal für zwei Tassen

made of cast iron, keeps the tea warm for
a long time, no bitterness, ideal for two cups

hecho de hierro fundido, mantiene el té caliente durante
mucho tiempo, sin amargar, ideal para dos tazas

en fonte, maintient le thé chaud pendant longtemps,
pas d'amertume, idéal pour deux tasses

	Ø cm	↑ cm	ltr.	€
10990	12,5 x 11	12,5	0,3	19,00



mit abnehmbarem Deckel
with removable lid



200 ml

Zuckerdosierer

sugar dispenser
azucarero
sucrier



mit Schraubverschluss, Dosier-Rohr Ø 15 mm

cover and dosingtube Ø 15 mm

con tapa y tubo dosificador Ø 15 mm

couvercle avec tube doseur Ø 15 mm

	Ø cm	↑ cm	ltr.	€
40508	6,5	14,5	0,20	9,90



10316
170 ml

10317
170 ml

Zuckerspender / Milchkännchen

sugar pourer / milk jug
dispensador de azúcar
sucrier doseur



matt poliert

satin polished finish

pulido efecto satinado

intérieur et extérieur poli mat

	Ø cm	↑ cm	ltr.	€
10316	5	15	0,17	8,60
10317	5	11,5	0,17	6,00



Portionsspender

dispenser
dispensador
présentoir



matt poliert, Spender für Milchportionen, Zuckertüten und Rührer, möbelschonende Unterseite

dispenser for condensed milk, sugar packs and stirrers

dispensador para leche condensada, sobres de azúcar, agitadores, base antiralladuras

idéal pour monodoses de crème ou lait, sucre en sachets longs, agitateurs, base revêtue anti-rayures

	Ø cm	↑ cm	€
00073	11	17,5	22,00



Zuckerkugel

sugar pot
azucarero
sucrier



hochglanzpoliert, mit Rolldecke

mirror polished finish, rolltop cover

pulido acabado brillante, tapa abatible

brillant, couvercle abattant

	Ø cm	↑ cm	€
00033	13,5	15	10,90



Zuckertüten-Box

sugar pocket holder
azucarero para bolsitas
porte-sachetsw de sucre



matt poliert, für ca. 15 Zuckertüten

satin polished finish, for ca. 15 sugar packets

acabado pulido efecto satinado, capacidad 15 sobrecillos

poli mat, pour 15 sachets

	cm	↑ cm	€
11579	9 x 7,5	5	7,50



Milchkännchen / Sahnegießer

milk / cream jug
jarra de leche/ crema
pichet à eau ou lait



	Ø cm	↑ cm	ltr.	€
10318	4	4	0,05	2,00
10319	4,8	5	0,09	2,40
10320	6	6	0,15	3,00



Flambierbrenner

chefs blow torch
soplete de cocina para flambear
chalumeau de cuisine



mit handelsüblichem Feuerzeuggas auffüllbar, Flamme einstellbar bis ca. 1300° C, Brenndauer von min. 60 Minuten

to be filled with commercial lighter gas, flame adjustable up to approx. 1300° C, burning time of at least 60 minutes

rellenable con gas de mechero comercial, llama ajustable hasta 1300 ° C, tiempo de combustión de al menos 60 minutos

rempli avec gaz pour briquet commercial, flamme réglable jusqu'à 1300 ° C, temps de combustion d'au moins 60 minutes

	Ø cm	↑ cm	€
77315	4,5	16,5	29,00



Milchkännchen, 4er Set

milk/cream jugs, 4 pcs. set
pack de 4 jarritas para leche o crema
pack de 4 crémiers



hochglanzpoliert, für Kaffeesahne, mit Griff, Inhalt à 25 ml
mirror polished finish, for coffee-cream, with handle, capacity à 25 ml
pulido brillante, para crema de café, con asa, capacidad 25 ml
brillant, avec anse, 25 ml

	Ø cm	↑ cm	pcs.	ltr.	€
10321	3,6	3,5	4	0,025	12,90



10334

Milch-/Universalkanne „ANTIHAFT“

non stick jug
jarra antiadherente
pichet antiadhésif



PTFE-antihaftbeschichtet, perfekt für die Herstellung von Milchschaum
PTFE coated, for baristas frothing hot milk
revestimiento PTFE, ideal para espume de leche
revêtement PTFE, idéal pour faire mousser le lait

	Ø cm	↑ cm	ltr.	€
10334	8	10	0,35	13,80
10335	9	11,5	0,6	16,90
10336	10,5	13	0,8	22,40



10328

Milch- / Universalkanne

milk / water jug
jarra leche / agua
pichet à eau / lait



außen hochglanzpoliert, innen matt poliert
outside mirror polished finish, inside satin polished finish
exterior brillante, interior satinado
extérieur brillant, intérieur mat satiné

	Ø cm	↑ cm	ltr.	€
10328	8	10	0,35	6,80
10329	9	11,5	0,6	9,80
10330	10,5	13	0,8	13,50
10331	12	16,5	1,3	18,50
10332	13,5	18	2	24,00



10323

Kaffeekanne

coffee pot
cafetera
pichet à café



hochglanzpoliert, mit Klappdeckel
mirror polished finish, with hinged cover
acabado brillante, tapa con bisagra
poli brillant, couvercle à charnière

	Ø cm	↑ cm	ltr.	€
10323	8	11,5	0,35	8,80
10322	9	14	0,6	12,00
10325	10,5	15,5	0,9	16,50
10326	12	18,5	1,5	22,50
10327	13,5	20	2	28,00



Teebrühsieb

snap mesh tea ball
infusor de té, pinza con malla
boule à thé avec pince

matt poliert, mit feinem Sieb, aufklappbar
satin polished finish, with fine mesh, hinged
acabado pulido efecto satinado, con malla fina, con bisagra
inox mat, maille fine, avec charnière



	∅ cm	→ cm	€
74750	4,5	15,5	2,10



Zitronenschnitzelpresse

lemon slice squeezer
pinza exprimelimon
pince presse citron

hochglanzpoliert, zum Auspressen von Zitronenscheiben
mirror polished finish, to press lemon slices
pulido brillante, para rodajas de limón
brillant, pour citrons en rondelle



	cm	€
71430	8 x 7	1,20



für ca. 30 Teebeutel
for approx. 30 teabags

Schale, 3-geteilt

bowl, 3-section
cuenco, 3 secciones
bol 3 compartiments



	cm	↑ cm	€
83536	17,5 x 7,5	4,5	5,00



Behälter

container
recipiente organizador
récipient de table



	cm	↑ cm	€
83537	10 x 4	6,5	3,00



Schale, 2-geteilt

bowl, 2-section
cuenco, 2 secciones
bol 2 compartiments



	cm	↑ cm	€
83538	17,5 x 7,5	4,5	5,00



Serviertablett „KAFFEEHAUS“

tray
bandeja
plateau



	cm	↑ cm	Farbe / Colour	€
84250	26,0 x 20,0	1,5	White	4,20
84252	28,5 x 21,5	1,5	White	4,80
84251	26,0 x 20,0	1,5	Black	4,20
84253	28,5 x 21,5	1,5	Black	4,80



Serviertablett „KAFFEEHAUS“

tray
bandeja
plateau



Innenfläche ziseliert, Rand eingerollt
rolled edge
borde redondeado, superficie decor relieve
bord rond, surface entièrement ciselée

	cm	pcs.	€
30114	30 x 22	48	2,80



Serviertablett „KAFFEEHAUS“

tray
bandeja
plateau



matt poliert, Rand eingerollt
satin polished finish, rolled edge
acabado pulido satinado, borde redondeado
effet satin mat, bord rond

	cm	↑ cm	€
30119	23 x 23	1,5	8,50



Serviertablett „KAFFEEHAUS“

tray
bandeja
plateau



matt poliert, Rand eingerollt
satin polished finish, rolled edge
acabado pulido efecto satinado, borde redondeado
effet satin, bord rond

	cm	↑ cm	€
30118	21,5 x 13	1,5	6,70

mattiert
satin polished finish



30126



hochglanzpoliert
mirror polished finish

Serviertablett „KAFFEEHAUS“

tray
bandeja
plateau



	cm	↑ cm		€
30126	25,5 x 19,5	2	mattiert / satin polished finish acabado efecto satinado / fini mat effet satin	6,30
30127	30 x 23	2	mattiert / satin polished finish acabado efecto satinado / fini mat effet satin	8,50
30136	25,5 x 19,5	2	hochglanzpoliert / mirror polished finish acabado espejo pulido / poli brillant miroir	6,30
30137	30 x 23	2	hochglanzpoliert / mirror polished finish acabado espejo pulido / poli brillant miroir	8,50

Serviertablett „KAFFEEHAUS“

tray
bandeja
plateau



matt poliert, oval, Rand eingerollt
satin polished finish, oval, rolled edge
pulido acabado efecto satinado, oval, borde redondeado
effet satin, ovale, bord rond



30111

matt poliert
satin polished finish

	cm	↑ cm		€
30111	19 x 15	1	für Zucker und Sahne / for sugar and cream para azúcar y crema / pour le sucre et la crème	4,30
30112	26,5 x 19	1	für eine Tasse / for one cup para una taza / pour une tasse	6,50
30113	29 x 22	1	für zwei Tassen / for two cups para dos tazas / pour deux tasses	6,90
30123	23 x 17,5	1	Eisdielen-Größe / icecream pralor size tamaño especial para heladerías / taille spéciale pour glaciers	6,10

Serviertablett „KAFFEEHAUS“

tray
bandeja
plateau



hochglanzpoliert, oval, Rand eingerollt
mirror polished finish, oval, rolled edge
pulido efecto espejo, ovalado, borde redondeado
effet brillant, ovale, bord rond



30116

hochglanzpoliert
mirror polished finish

	cm	↑ cm		€
30115	19 x 15	1	für Zucker und Sahne / for sugar and cream para azúcar y crema / pour le sucre et la crème	4,30
30116	26,5 x 19	1	für eine Tasse / for one cup para una taza / pour une tasse	6,50
30117	29 x 22	1	für zwei Tassen / for two cups para dos tazas / pour deux tasses	6,90
30124	23 x 17,5	1	Eisdielen-Größe / icecream pralor size tamaño especial para heladerías / taille spéciale pour glaciers	6,10



Serviertablett „HAPPY HOUR“

tray
bandeja
plateau



rutschfeste Oberfläche
non-slip surface
superficie anti-deslizante
surface antidérapante

	Ø cm	↑ cm	Farbe / Colour	€
00510	32	1,5	■	20,60
00511	38	1,5	■	25,00
00515	43	1,5	■	28,90



00548

Tablett „GASTRO“

tray
bandeja
plateau



rutschfeste Oberfläche
non-slip surface
superficie anti-deslizante
surface antidérapante

	Ø cm	↑ cm	Farbe / Colour	€
00547	27,5	2	■	6,90
00548	35,5	2	■	8,70
00549	40,5	2	■	10,50



Tablett „BISTRO“

tray
bandeja
plateau



rutschfest, mit 2 Griffmulden und Stapelrand
non-slip, two open handles, stackable edge
anti-deslizante, 2 asas
antidérapant, 2 anses

	Ø cm	↑ cm	Farbe / Colour	€
84045	35,5	4,5	■	22,00



00500

00507

Bierglasträger „RUTSCHFEST“

beer rack
bandeja para cerveza
porte verre à bière



rutschfeste Oberfläche
non-slip surface
superficie anti-deslizante
surface antidérapante

	Ø cm	↑ cm	Farbe / Colour		€
00500	36	3,5	■	rund / round	19,00
00501	36	3,5	■	rund / round	19,00
	cm	↑ cm	Farbe / Colour		€
00506	28 x 20	1,5	■	oval	8,50
00507	28 x 20	1,5	■	oval	8,50



Serviertablett „RUTSCHFEST“

tray non-slip
bandeja antideslizante
plateau antiglisse

rutschfeste Oberfläche

non-slip surface
superficie antideslizante
surface antidérapante



	cm	↑ cm	GN	Farbe / Colour	€
00502	53,0 x 32,5	1,5	1/1	■	21,90
00508	46,0 x 36,0	2		■	20,80
00505	53,0 x 32,5	1,5	1/1	■	21,90
00503	53,0 x 37,0	1,5		■	25,00



Tablett

tray
bandeja
plateau

rutschfest, Holzdekor-Laminat

non-slip, coated wood
antideslizante
antidérapant



	cm	↑ cm		€
00524	43,5 x 31,5	1,5		17,20
00525	52,0 x 39,0	1,5		21,80
00526	60,5 x 42,5	1,5		27,50



Partyplatte

partytray
bandeja party
plateau party

Innenfläche ziseliert, Rand eingerollt

rolled edge, decorated surface
borde redondeado, superficie totalmente decorada
bord rond, surface entièrement ciselée



	cm	VE / unit		€ / pc.
00391	46 x 34	48	oval / oval	3,20
00393	Ø 35	48	rund / round	3,20



Partyplatte

partytray
bandeja party
plateau party

Innenfläche ziseliert, Rand eingerollt

rolled edge, decorated surface
borde redondeado, superficie totalmente decorada
bord rond, surface entièrement ciselée



	cm	VE / unit	GN	€ / pc.
00392	41 x 31	48	–	3,20
00394	53 x 32,5	36	1/1	5,20



Fast Food-Tablett

snack tray
bandeja autoservicio y snacks
plateau self-service et snacks



	cm	↑ cm	GN	Farbe / Colour	€
00530	35 x 27	2			3,10
00535	41 x 30,5	2			4,10
00540	45 x 35,5	2			5,10
00552	53,0 x 32,5	2	1/1		6,20

	cm	↑ cm	GN	Farbe / Colour	€
00531	35 x 27	2			3,10
00536	41 x 30,5	2			4,10
00541	45 x 35,5	2			5,10
00553	53,0 x 32,5	2	1/1		6,20

	cm	↑ cm	GN	Farbe / Colour	€
00532	35 x 27	2			3,10
00537	41 x 30,5	2			4,10
00542	45 x 35,5	2			5,10
00554	53,0 x 32,5	2	1/1		6,20

	cm	↑ cm	GN	Farbe / Colour	€
00533	35 x 27	2			3,10
00538	41 x 30,5	2			4,10
00543	45 x 35,5	2			5,10
00555	53,0 x 32,5	2	1/1		6,20



Tablett

tray
bandeja
plateau



rutschfest, Mahagonifurnier
non-slip, woodform, mahogany
antideslizante
antidérapant

	Ø cm	↑ cm	€
00528	31	3,5	17,20
00529	35,5	3,5	21,90



rutschfest / non-slip

Tablett

tray
bandeja
plateau



rutschfest, Holzdekor-Laminat
non-slip, coated wood
antideslizante
antidérapant

	cm	↑ cm	€
00520	23,0 x 16,0	1,0	7,40
00521	26,0 x 20,0	1,0	7,60
00522	29,0 x 21,0	1,0	9,90
00523	38,0 x 27,0	1,5	14,20



00522



Rechnungstablett, 2er Set
bill presenter, 2 pcs. set
porta cuenta, set de 2 unidades
porte-addition, set de 2 pièces



1 Edelstahl-Tablett hochglanzpoliert + 1 klappbare Ledermappe mit Stifflasche, mit Magnethalterung

1 stainless tray mirror polished finish + 1 leather presenter, with magnetic system

1 bandeja de acero inoxidable pulido brillante + 1 presentador de cuero con sistema magnético

1 plateau inox poli brillant + 1 pochette cuir aimantée

	cm	↑ cm	€
30109	20 x 16	2	24,40



Rechnungstablett
bill presenter
porta cuenta
porte-addition



mit Klemme für Rechnung

with clip for bill

con clip para la nota

avec clip pour la note

	cm	↑ cm	€
30108	20,0 x 12,0	0,5	1,70



Rechnungstablett
bill tray
bandeja porta-cuenta
plateau addition



mit Klemme für Rechnung

with clip for bill

con clip para la nota

avec pince

	cm	↑ cm	€
30110	17 x 11	1	5,80



Untersetzer

coaster
posavasos
plateau sous-verre



hochglanzpoliert, schwere Ausführung, Rand eingerollt

mirror polished finish, heavy quality, rolled edge

acabado pulido efecto espejo, alta calidad, borde redondeado

effet miroir, bord rond, qualité extra

	Ø cm	pcs.	€
35711	10	6	15,00
35912	12	6	13,90

35912

Rand eingerollt

Bar . Café . Drinkware



Windascher „DIAMOND“

ashtray
cenicero
cendrier



Metall verchromt, mit Bajonettverschluss
metal chrome plated, bayonet lock
metal cromado, cierre de bayoneta
metal chrome, verrouillage par baïonnette

	Ø cm	↑ cm	Farbe / Colour		€
00565	12,0	8,0		Glas gefrostet / glass frosted	9,90
00566	12,0	8,0		Glas glänzend / glass shiny	9,90
00567	12,0	8,0		Glas glänzend / glass shiny	9,90



Windascher

ashtray
cenicero
cendrier



Metall verchromt, Glas gefrostet, mit Bajonettverschluss
metal chrome plated, glass frosted, bayonet lock
metal cromado, opaco mate, cierre de bayoneta
métal chromé, mat, verrouillage par baïonnette

	Ø cm	↑ cm	Farbe / Colour		€
00560	9,5	8,0			7,90
00561	9,5	8,0			7,90
00562	9,5	8,0			7,90
00563	9,5	8,0			7,90
00564	9,5	8,0			7,90





Drehascher „PUSH“

ashtray
cenicero
cendrier



Deckel mit Drehmechanismus, mit Bajonettverschluss
with rotary button, bayonet lock
con botón giratorio, cierre de bayoneta
tourne par pression sur le bouton, verrouillage par baïonnette



Drehmechanismus
rotary button

	Ø cm	↑ cm	€
00568	9,5	11	9,90
00569	12,0	11	12,90



Windascher

ashtray
cenicero
cendrier



Metall verchromt, Glas gefrostet, mit Bajonettverschluss
metal chrome plated, glass frosted, bayonet lock
metal cromado, opaco mate, cierre de bayoneta
métal chromé, mat, verrouillage par baïonnette

	Ø cm	↑ cm	Farbe / Colour	€
00582	9,5	8	Black	7,90
00583	9,5	8	Yellow	7,90
00584	9,5	8	Teal	7,90
00585	9,5	8	White	7,90



Drehascher „KLASSIKER“

ashtray
cenicero
cendrier giratoire



Deckel mit Drehmechanismus
with rotary button
con botón giratorio
tourne par pression sur le bouton

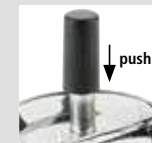

Drehmechanismus
rotary button

	Ø cm	↑ cm	Farbe / Colour	€
00054	13	10,5	Silver	7,90
00056	10,5	11	Black	6,40



Aschenbecher

ashtray
cenicero
cendrier



Deckel hochglanzpoliert, Behälter matt poliert, mit Windschutzdeckel
lid mirror polished finish, container satin polished finish, with windcover
con tapa antiviento pulida brillante y contenedor pulido efecto satinado
couverture anti-vent brillant, corps poli mat satiné

	Ø cm	↑ cm	€
00052	12	5,5	8,20



Aschenbecher

ashtray
cenicero
cendrier

matt poliert, mit Windschutzdeckel
satin polished finish, with windcover
acabado pulido satinado apilable, tapa para el viento
poli mat, empilable, couvercle anti-vent



	Ø cm	↑ cm	€
00090	10	4,5	7,20
00091	12	4,5	8,00



Aschenbecher

ashtray
cenicero
cendrier

matt poliert, hochwertige schwere Ausführung
satin polished finish, high quality, heavy gauge
pulido satinado, alta calidad, apilable
poli mat, empilable, belle qualité



	Ø cm	↑ cm	€
00048	8	3	7,40
00050	10	3	8,50



Wind-Aschenbecher „XL“

ashtray
cenicero
cendrier



	Ø cm	↑ cm	Farbe / Colour	€
84212	14,5	4,5	White	5,60
84213	14,5	4,5	Black	5,60



Wind-Aschenbecher

ashtray
cenicero
cendrier



	Ø cm	↑ cm	Farbe / Colour	€
83488	11,5	5	White	5,00
83489	11,5	5	Black	5,00



Wind-Aschenbecher

ashtray
cenicero
cendrier



	Ø cm	↑ cm	Farbe / Colour	€
83610	10	4	White	4,20
83612	12	4,5	White	4,60
83611	10	4	Black	4,20
83613	12	4,5	Black	4,60

NEW



Wind-Aschenbecher „SMOKY“

ashtray
cenicero
cendrier



Metall verzinkt, mit abnehmbarem Deckel
metal galvanized, with removable lid
metal galvanizado, con tapa extraíble
métal galvanisé, avec couvercle amovible

	Ø cm	↑ cm	€
00578	8,5	11,5	4,40

NEW



Wind-Aschenbecher „ELEMENT“

ashtray
cenicero
cendrier



Beton, mit möbelschonender Unterseite
concrete, with non-scratching undersurface
hormigón, con base anti rayaduras
béton, avec revêtement antirayures

	Ø cm	↑ cm	€
00570	10,5	5,0	6,90



83614

Aschenbecher

ashtray
cenicero
cendrier



	Ø cm	↑ cm	Farbe / Colour	€
83614	9,5	4,5	White	2,50
83616	9,5	4,5	Black	2,50

hot price



Aschenbecher, 3er Set

ashtray, 3 pcs. set
set de cenicero 3 piezas
set de 3 mini cendriers



	Ø cm	↑ cm	pcs.	Farbe / Colour	€
00576	8	3	3	Black	2,20



71400

Rezeptionsglocke

ring bell
timbre
sonnette



	Ø cm	↑ cm	Farbe / Colour	€
71400	8,5	6	Black	4,40
71433	10	6,5	Black	6,60



Standascher „DIABOLO“

standing ashtray
cenicero de pie
cendrier sur pied



für den Innen- und Außenbereich, inkl. 1,5 kg Sand, eine Ascheschale für die Sandbefüllung und ein Metallsieb

for in,- outdoor use, included a bag of sand and a metal sieve

uso en interior o exterior, incluye una bolsa de arena y embudo de metal

usage en intérieur ou extérieur, livré avec un sac de sable et entonnoir métal

	Ø cm	↑ cm	€
00574	40	60	64,00



vielseitig nutzbar
versatile



zerlegbar und stapelbar
dismountable and stackable

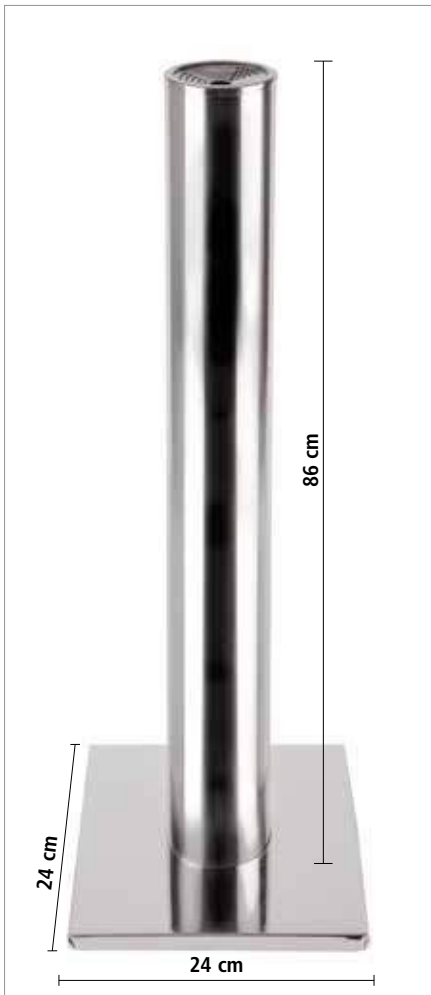

Standascher / Abfalleimer „SMOKERS POINT“

floor standing ashtray
cenicero de pie
cendrier sur pied



glanz poliert, mit herausnehmbaren Aschereinsatz

mirror polished finish, with ashtray insert and with litter bin

pulido acabado con cenicero y papelera

poli brillant inséré, extractible pour vidage facile

	Ø cm	↑ cm	ltr.	€
00579	9 / 24 x 24	86	3	114,00



3 Liter Einsatz
3 litre ashtray insert





Standascher / Abfalleimer

litter bin / ashtray
papelera con cenicero superior
poubelle avec cendrier supérieur



mit herausnehmbaren Aschereinsatz und herausnehmbaren verzinkten Innenbehälter / Eimer
with ashtray insert and litter bin
con cenicero y papelera metálica
cendrier et corbeille à détritus

	Ø cm	↑ cm	€
00575	30	60	52,00



Tretbeutelhalter

pedal bin
soporte a pedal
poubelle à pédale



geeignet für Müllbeutel bis 120 ltr., 110 x 70 cm
suitable for bags up to 120 ltr., 110 x 70 cm
apto para bolsas hasta 120 l., medidas sin bolsa 110 x 70 cm
apte pour sacs de 120 l., dim. sans sac 110 x 70 cm

	cm	↑ cm	€
00580	59 x 43	96	114,00



leichte Bedienung, Trittmechanismus
easy handling, step on bin

2 Lenkrollen mit Feststellern
2 wheels with brakes

Gummilippe 55 cm breit, Abstand zwischen Gummilippe und Bodenblech 82 cm





Servier- & Küchenhelfer

servicing items & kitchentools

herramientas de cocina

outils de cuisine

Kellen
Schnitzer
Wender
Zangen
Löffel

cucharones
talladores
espátulas
pinzas
cucharas

ladles
carvers
turners
tongs
spoons

louches
bourdes
spatules
pinces
cuillères



220°C
POLYAMID
BEST TECHNOLOGY

Das Profimaterial Polyamid besteht aus Nylon und Fiberglas. Hitzebeständig bis 220°C, extra hochwertige Profi-Qualität, gut geeignet für antihafbeschichtete Pfannen, ergonomischer Griff.

Polyamide is made of nylon and fiberglass. Heat-resistant up to 220°C, extra high quality, perfect for non-stick-coated pots and pans, ergonomic handle.

Poliamide de nylon y fibra de vidrio. Brevemente al calor hasta 220°, calta calidad profesional, ideal para sartenes antiadherentes, mango ergonómico.

Polyamide de nylon et fibre de verre, haute résistance brièvement à la chaleur jusque 220°C, qualité professionnelle, idéal pour les poêles antiadhérentes, manche ergonomique.



Bratenwender

turner
espátula
spatule



	cm	→ cm	€
00603	11 x 9,5	Griff / handle 23	5,30



Pfannenwender

turner
espátula
spatule



	cm	→ cm	€
00600	11,5 x 9,5	Griff / handle 23	5,20



Pfannenwender

turner
espátula
spatule



	cm	→ cm	€
00604	15 x 7,5	Griff / handle 15	3,70



Pfannenwender

turner
espátula
spatule



	cm	→ cm	€
88642	14 x 7	Griff / handle 18	3,80



Pfannenwender

turner
espátula
spatule



	cm	→ cm	€
88640	13 x 6,5	Griff / handle 15	3,70



Servierlöffel
serving spoon
cuchara de servicio
cuillère de service



	cm	→ cm		€
88608	12 x 7	Griff / handle 23		5,20
00607	12 x 7	Griff / handle 23	perforiert	5,00



Schaumlöffel
skimmer
espumadera
écumoire



	Ø cm	→ cm		€
00602	11,5	Griff / handle 23		5,30



Schöpflöffel
ladle
cucharón
louche



	Ø cm	→ cm	ltr.	€
00606	9	Griff / handle 23	0,1	5,50



Toastzange
sandwich tong
pinza para sandwich
pince à toasts



	cm	→ cm		€
00601	10 x 8	Griff / handle 17		6,80



Spaghettizange
spoon
pinza espaguetis
pince universelle ou à spaghettis



	cm	→ cm		€
88637	9	Griff / handle 15		5,30



Salatzange
salad tong
pinza ensalada
pince à salade



	cm	→ cm		€
00605	10 x 6	Griff / handle 23		5,50



Wender
turner
espátula
spatule



	cm	→ cm	€
00645	9,0 x 8,5	Griff / handle 21	3,90



Schaumlöffel
skimmer
espumadera
écumoire



	Ø cm	→ cm	€
00646	10,5	Griff / handle 23	3,90



Servierlöffel
serving spoon
cuchara de servicio
cuillère de service



	cm	→ cm	€
00647	10 x 6	Griff / handle 21	3,90



Schöpflöffel
ladle
cucharón
louche



	cm	→ cm	€
00648	9 x 8	Griff / handle 23	3,90



Spaghettilöffel
spaghetti spoon
cuchara para espaguetis
cuillère à spaghettis



	cm	→ cm	€
00649	9 x 7	Griff / handle 23	3,90

STOP-TOOLS

Die STOP-Funktion verhindert, dass Gabel oder Löffel in das Gefäß rutschen.

The smart STOP-function prevent forks and spoon not to slip into the vessel.

La función STOP evita que los cubiertos se caigan dentro del recipiente. Antideslizante.

La fonction STOP empêche les couverts de glisser dans le récipient.



Servierlöffel

serving spoon
cuchara de servicio
cuillère de service



Materialdicke 2,5 mm, ergonomischer, rutschfester Griff
ergonomic antislip handle
mango ergonómico antideslizante
manche ergonomique antidérapante

	cm	→ cm	€
00834	10 x 7,5	Griff / handle 17	9,90



Servierlöffel geschlitzt

slotted spoon
cuchara de servicio
cuillère de service



Materialdicke 2,5 mm, ergonomischer, rutschfester Griff
ergonomic antislip handle
cuchara de servicio ranurada
cuillère de service rainurée

	cm	→ cm	€
00833	10 x 7,5	Griff / handle 17	9,90



Schöpflöffel

ladle
cucharón
louche



Materialdicke 2,5 mm, ergonomischer, rutschfester Griff
ergonomic antislip handle
mango ergonómico antideslizante
manche ergonomique antidérapante

	Ø cm	→ cm	€
00832	9	Griff / handle 17	10,40



Fleischgabel

meat fork
tenedor de carne
fourchette à viande



Materialdicke 2,5 mm, ergonomischer, rutschfester Griff
ergonomic antislip handle
mango ergonómico antideslizante
manche ergonomique antidérapante

	cm	→ cm	€
00831	10,5 x 4	Griff / handle 17	9,90



Servierlöffel geschlitzt

serving spoon
cuchara de servicio ranurada
cuillère de service rainurée

ergonomischer, rutschfester Griff

ergonomic antislip handle
mango ergonómico antideslizante
manche ergonomique antidérapante



	cm	→ cm		€
00664	11 x 7	Griff / handle 25		6,00



Servierlöffel

serving spoon
cuchara de servicio
cuillère de service

ergonomischer, rutschfester Griff

ergonomic antislip handle
mango ergonómico antideslizante
manche ergonomique antidérapante



	cm	→ cm		€
00662	11 x 7	Griff / handle 25		6,00



Schöpföffel

ladle
cucharón
louche

ergonomischer, rutschfester Griff

ergonomic antislip handle
mango ergonómico antideslizante
manche ergonomique antidérapante



	cm	→ cm	ltr.	€
00670	9 x 8	Griff / handle 25	0,15	6,60



Wender

slotted turner
espátula para plancha
spatule pour le grill

ergonomischer, rutschfester Griff

ergonomic antislip handle
mango ergonómico antideslizante
manche ergonomique antidérapante



	cm	→ cm		€
00668	10 x 8	Griff / handle 25		6,60



Fleischgabel

meat fork
tenedor de carne
fourchette à viande

ergonomischer, rutschfester Griff

ergonomic antislip handle
mango ergonómico antideslizante
manche ergonomique antidérapante



	cm	→ cm		€
00666	10 x 3,5	Griff / handle 25		6,00



Schöpflöffel „PROFI“

ladle
cacillo
louche



	Ø cm	→ cm	ltr.	€
00710	5	Griff / handle 27	0,030	10,80
00711	6	Griff / handle 28	0,050	11,40
00712	7	Griff / handle 30	0,080	11,80
00713	8	Griff / handle 32	0,125	12,80
00714	9	Griff / handle 33	0,150	14,60
00715	10	Griff / handle 35	0,250	15,40
00716	11	Griff / handle 36	0,300	16,00
00717	14,5	Griff / handle 38	0,550	16,90



Schaumlöffel „PROFI“

skimmer
espumadera
écumoire



	Ø cm	→ cm	€
00720	8	Griff / handle 32	11,20
00721	10	Griff / handle 34	12,40
00722	12	Griff / handle 37	13,30
00723	14	Griff / handle 40	14,40



Wender „PROFI“

turner
espátula
spatule



	cm	→ cm	€
00730	10 x 11,5	Griff / handle 38	14,40



Servierlöffel „PROFI“

serving spoon
cuchara de servicio
cuillère de service



	cm	→ cm	€	
00671	11 x 7	Griff / handle 29	geschlitzt / slotted	8,60
00672	11 x 7	Griff / handle 29		8,60



Spaghettilöffel „PROFI“

spaghetti spoon
cuchara de espaguetis
cuillère à spaghettis



	cm	→ cm	€
00673	10 x 7	Griff / handle 29	9,30

BANQUET



Die Vorlegeserie BANQUET ist die passende Ergänzung zum Servieren am Buffet. Durch die mattierte Oberfläche und das gebogene Griffende wird BANQUET praktischen und optischen Ansprüchen gerecht.

The series BANQUET is the perfect addition for serving at the buffet. Due to the matt surface and the curved handle, BANQUET meets practical and optical requirements.

La serie BANQUET es la adición perfecta para servir en el buffet. Debido a la superficie mate y al mango curvado, BANQUET cumple con requisitos prácticos y ópticos.

La série BANQUET est l'ajout parfait pour servir au buffet. Grâce à la surface mate et la poignée incurvée, BANQUET répond aux exigences pratiques et optiques.



Salat- / Servierlöffel „BANQUET“

salad spoon / serving spoon
cuchara para ensalada / cuchara de servicio
cuillère à salade / cuillère de service



	cm	→ cm	€
00588	6 x 5	Griff / handle 17	4,80
00590	7,5 x 6	Griff / handle 21	7,00



Salatgabel „BANQUET“

salad fork
tenedor de servicio para ensalada
fourchette de service pour la salade



	cm	→ cm	€
00589	6 x 5	Griff / handle 17	4,80
00591	7,5 x 6	Griff / handle 21	7,00



Pfannenwender „BANQUET“

turner
espátula
spatule



	cm	→ cm	€
00587	10 x 7,5	Griff / handle 21	7,90

Chafing Dish Löffel „BANQUET“

 serving spoon
 cuchara para servir
 cuillère de service

	cm	→ cm	€
00592	11 x 6,5	Griff / handle 24	7,90
00593	11 x 6,5	Griff / handle 24 geschlitzt / slotted	7,90

Dressinglöffel „BANQUET“

 dressing spoon
 cuchara de aliño
 cuillère à vinaigrette

	cm	→ cm	€
00594	6 x 4	Griff / handle 30	9,90

Schöpflöffel „BANQUET“

 ladle
 cucharón
 louche

	cm	→ cm	€
00595	8,5 x 7,5	Griff / handle 24	12,90

Fleischgabel „BANQUET“

 meat fork
 tenedor de carne
 fourchette à viande

	cm	→ cm	€
00596	8 x 2,5	Griff / handle 13	4,00

Serviergabel „BANQUET“

 fork
 tenedor de servicio
 fourchette de service

	cm	→ cm	€
00597	9 x 4	Griff / handle 21	7,20

Tortenheber „BANQUET“

 cake lifter
 pala de tartas
 pelle à gâteau

eine Kante gezahnt
 one edge serrated
 un borde serrado
 denté sur un côté

	cm	→ cm	€
00598	14 x 6	Griff / handle 13	6,20



Servierlöffel „CLASSIC“

serving spoon
cuchara de servicio
cuillère de service



hochglanzpoliert, perforiert, Löcher Ø 4 mm, ergonomisch profilierter Hohl-Griff
mirror polished finish, perforated, holes Ø 4 mm, ergonomic designed handle
pulido brillante agujeros de Ø 4 mm, asa ergonómica
brillant, trous Ø 4 mm, manche ergonomique

	cm	→ cm	€
75903	9 x 6	Griff / handle 22	8,50



Servierlöffel „CLASSIC“

serving spoon
cuchara de servicio
cuillère de service



hochglanzpoliert, ergonomisch profilierter Hohl-Griff
mirror polished finish, ergonomic designed handle
pulido brillante, asa ergonómica
brillant, manche ergonomique

	cm	→ cm	€
75904	9 x 6	Griff / handle 22	8,20



Schaumlöffel „CLASSIC“

skimmer
espumadera
écumoire



hochglanzpoliert, ergonomisch profilierter Hohl-Griff
mirror polished finish, ergonomic designed handle
pulido acabado brillante, mango ergonómico
brillant, manche ergonomique

	Ø cm	→ cm	€
75911	11	Griff / handle 25	8,50



Pfannenwender geschlitzt „CLASSIC“

turner
espátula ranurada
spatule rainurée



	cm	→ cm	€
75910	9 x 8	Griff / handle 21	8,50



Tranchiergabel „CLASSIC“

fork
tenedor para carne
fouchette à viande



hochglanzpoliert, ergonomisch profilierter Hohl-Griff, Zinkenlänge 8 cm
mirror polished finish, ergonomic designed handle, length of prongs 8 cm
pulido brillante, asa ergonómica, largo de las puas 8 cm
brillant, manche ergonomique, dents long. 8 cm

	cm	→ cm	€
75905	8,5 x 2,5	Griff / handle 21	7,60



Salatlöffel „CLASSIC“

salad spoon
cuchara para ensalada
cuillère à salade

hochglanzpoliert, ergonomisch profilierter Hohl-Griff
mirror polished finish, ergonomic designed handle
inox brillante, asa ergonómica
brillant, manche ergonomique



	cm	→ cm	€
75902	8 x 6	Griff / handle 21	8,50



Salatgabel „CLASSIC“

salad fork
tenedor de servicio para ensalada
fourchette de service pour la salade

hochglanzpoliert, ergonomisch profilierter Hohl-Griff
mirror polished finish, ergonomic designed handle
pulido brillante, asa ergonómica
brillant, manche ergonomique



	cm	→ cm	€
75901	8 x 6	Griff / handle 21	8,70

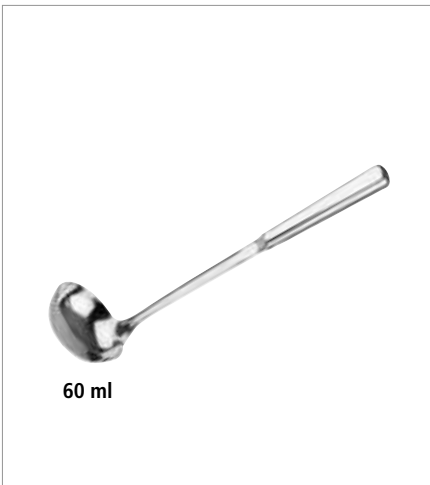

Suppenkelle „CLASSIC“

soup ladle
cucharón de sopa
louche de service

hochglanzpoliert, ergonomisch profilierter Hohl-Griff
mirror polished finish, ergonomic designed handle
pulido brillante, asa ergonómica
brillant, manche ergonomique



	Ø cm	→ cm	ltr.	€
75907	7	Griff / handle 24	0,06	9,30

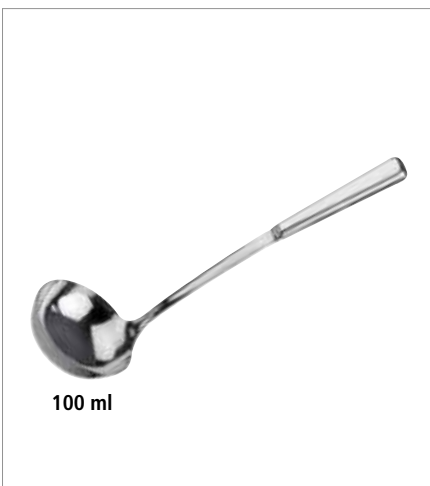

Suppenkelle „CLASSIC“

soup ladle
cucharón de sopa
louche de service

hochglanzpoliert, ergonomisch profilierter Hohl-Griff
mirror polished finish, ergonomic designed handle
pulido brillante, asa ergonómica
brillant, manche ergonomique



	Ø cm	→ cm	ltr.	€
75908	9	Griff / handle 25	0,1	9,60

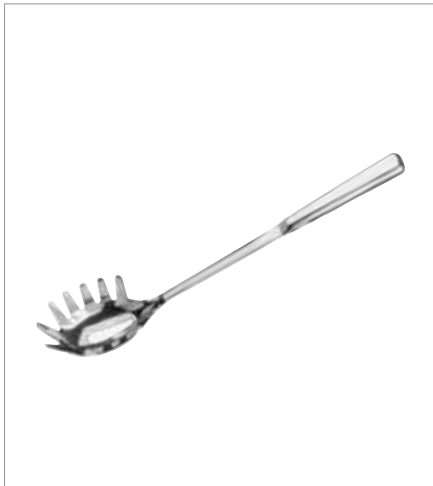

Spaghettiheber „CLASSIC“

spaghetti server
tenedor espaguetis
cuillère à spagettis



hochglanzpoliert, ergonomisch profilierter Hohl-Griff
mirror polished finish, ergonomic designed handle
acabado brillante, asa ergonómica
brillant, manche ergonomique

	cm	→ cm		€
75909	8 x 6,5	Griff / handle 23		9,10



Saucengießlöffel „CLASSIC“

sauce / gravy ladle
cucharón de salsa
cuillère à sauce



hochglanzpoliert, ergonomisch profilierter Hohl-Griff, fugenlos
mirror polished finish, ergonomic designed handle, seamless
pulido brillante, asa ergonómica, sin soldadura
brillant, manche ergonomique, monobloc (sans soudure)

	cm	→ cm	ltr.	€
75906	7 x 5,5	Griff / handle 23	0,02	8,00



Tortenmesser „CLASSIC“

cake knife
porcionador de pastel
couteau à tarte



eine Kante gezahnt 15,5 cm
one edge serrated 15,5 cm
un borde serrado de 15,5 cm
denté sur un côté à 15,5 cm

	cm	→ cm		€
75912	4,5 x 1	Griff / handle 12		9,30



Tortenheber „CLASSIC“

cake lifter
pala de tartas
pelle à gâteau



hochglanzpoliert, mit einer gezahnten Kante, ergonomisch profilierter Hohl-Griff
mirror polished finish, one edge serrated, ergonomic designed handle
pulido brillante, canto dentado, mango ergonómico
brillant, bord microdenté, manche ergonomique

	cm	→ cm		€
75900	5 x 1	Griff / handle 11		7,60



Salatzange

salad serving tong
pinza de ensalada
pinçe à servir la salade

hochglanzpoliert, einfache Handhabung
mirror polished finish, convenient handling
pulido brillante, manejo cómodo
brillant, manipulation aisée



	cm	→ cm	€
00685	7,0 x 4,5	25	15,00



Universalzange

multipurpose tong
pinzas multiusos
pinçe multi-usages

hochglanzpoliert, einfache Handhabung
mirror polished finish, convenient handling
pulido brillante, manejo cómodo
brillant, manipulation aisée



	cm	→ cm	€
00688	7,0 x 4,5	25	15,00



Brot- und Gebäckzange

bread and pastry tong
pinza para pan y bollería
pinçe à pain ou viennoiseries

hochglanzpoliert, einfache Handhabung
mirror polished finish, convenient handling
pulido brillante, manejo cómodo
brillant, manipulation aisée



	cm	→ cm	€
00686	7,0 x 4,5	25	15,00



Brot- und Gebäckzange

bread and pastry tong
pinza para pan y bollería
pinçe à pain ou viennoiseries

hochglanzpoliert, einfache Handhabung
mirror polished finish, convenient handling
pulido brillante, manejo cómodo
brillant, manipulation aisée



	cm	→ cm	€
00687	7,0 x 4,5	25	15,00



Allzweckzange
multipurpose tong
pinza multi-usos
pince universelle multi-usages



hochglänzend, mit Feder und Verschlusschieber, dekorative Greiferform
high-gloss finish, with spring and retaining clip, decorative gripper form
pulido brillante, con muelle y cierre deslizante, gancho con forma decorativa
finition brillante, avec mécanisme de verrouillage, forme de pince décorative

	cm	→ cm	€
88643	4 x 3	24	2,90
88644	4 x 3	30	3,60
88645	4 x 3	40	3,90



Aufschnitt- / Allzweckzange
sausage tong
pinza salchichas
pince à saucisses



hochglanzpoliert, fugenlos
mirror polished finish, seamless
pulido brillante, sin soldadura
brillant, monobloc

	cm	→ cm	€
75806	3 x 2,5	16	3,60



Gebäckzange
pastry tong
pinza para pasteles
pince à gâteaux



hochglanzpoliert, fugenlos, extra schwere Qualität
mirror polished finish, seamless, extra heavy gauge
pulido brillante, sin soldadura, alta calidad, resistente
brillant, monobloc, qualité extra, robuste

	cm	→ cm	€
75807	8,5 x 4	27,5	8,90



Universalzange
general tong
pinza universal
pince universelle



hochglanzpoliert, einseitig geschlitzt
mirror polished finish, slotted on one side
acabado brillante, agujereada en un lado
brillant, perforée d'un seul côté

	cm	→ cm	€
75800	5 x 2	24	4,50



Salatzange

salad tong
pinza ensalada
pinçe à salade



hochglanzpoliert, beidseitig geschlitzt
mirror polished finish, slotted on both side
acabado brillante, agujereada en 2 lados
brillant, perforéedes 2 côtés

	cm	→ cm	€
75801	5 x 2	24	5,80



Spaghettizange

spaghetti tong
pinza espaguetis
pinçe à spaghettis



hochglanzpoliert, fugenlos
mirror polished finish, seamless
acabado brillante, sin soldaduras
brillant, monobloc

	cm	→ cm	€
75810	6 x 3	19	4,30



Pinzettzange

fine tong / tweezer
pinza de emplatar
pinçe à dresser



hochglanzpoliert, geriffelte Grifffläche, schwere Qualität
mirror polished finish, ribbed handle, heavy gauge
acabado brillante, mango cómodo ranurado, alta calidad
brillant, manche rainuré antiglisse, qualité extra

	cm	→ cm	€
75809	1,5 x 1	30	7,80



Pinzettzange

fine tong / tweezer
pinza de emplatar
pinçe à dresser



hochglanzpoliert, geriffelte Grifffläche, abgerundete Spitzen vorne, schwere Qualität
mirror polished finish, ribbed handle, rounded on the tops, heavy gauge
acabado brillante, mango cómodo ranurado, alta calidad, puntas redondeadas
brillant, manche rainuré antiglisse, qualité extra, pointes arrondies

	cm	→ cm	€
75808	1 x 1	14,5	5,00



Gebäckzange

pastry tong
pinza para pasteles
pince à gâteaux

hochglanzpoliert, perforiert
mirror polished finish, perforated
pulido brillante, perforado
brillant, perforée



	cm	→ cm	€
75804	6,5 x 3	19,5	7,80



Gebäck- / Tortenzange

pastry tong
pinza para pasteles
pince à gâteaux

hochglanzpoliert, fugenlos
mirror polished finish, seamless
acabado brillante, sin soldadura
brillant, monobloc



	cm	→ cm	€
75803	7 x 3,5	17,5	4,90



Eisportionierer

ice cream scoop
cuchara para helado
cuillère à glace

hochglanzpoliert, mit Edelstahlfeder (physikalisch bedingt nicht korrosionsbeständig)
mirror polished finish, spring steel, spring is not stainless
pulido brillante, muelle de acero especial, no resistente al óxido
poli brillant, ressort acier spécial, non résistant à l'oxydation



	cm	→ cm	ltr.	€
71006	23,3 x 6,5	23	1/12	10,50
71005	22,7 x 6	22	1/16	10,50
71004	22,5 x 6	22	1/20	10,50
71003	22 x 6	21,5	1/24	10,50
71002	21,5 x 6	21,5	1/30	10,50
71001	21,5 x 6	21	1/36	10,50



Messlöffelsatz

set measuring spoon
juego de cucharas medidoras
jeu de cuillère à mesure

Löffel hochglanzpoliert, Stiele matt poliert, Skalierung:
1 Esslöffel, 1 Teelöffel, 1/2 Teelöffel, 1/4 Teelöffel

bowl mirror polished finish, handles satin polished finish, measures:
table spoon, tea spoon, 1/2 tea spoon, 1/4 tea spoon

bol medidor brillante, mango mate medidas:

1 cuchara de sopa, 1 cuchara de té, 1/2 cuchara de té, 1/4 cuchara de té

corps brillant, manche mat, mesures:

1 cuillerée à soupe, 1 cuillerée à thé, 1/2 cuillère à thé, 1/4 de cuillère à thé



	cm	€
75600	14 x 4,5	5,80



Eierschneider

egg cutter
corta huevos
coupe-oeufs

zum Längs- und Querteilen von hart gekochten Eiern

to cut hard-boiled eggs
corta a rodajas un huevo duro
en rondelles



	cm	↑ cm	€
88099	14,5 x 8	2,5	2,10



Hummerbrecher

lobster cracker
pinza bogavante
pince à homard



	cm	€
74201	14 x 5,5	5,50



Feinkostlöffel, 6er Set

delicatessen spoon, 6 pcs. set
cuchara gourmet, set de 6
cuillère gourmet, set de 6



	Ø cm	→ cm	pcs.	Farbe / Colour	€
88628	6	23	6	■	8,50



Feinkost- / Olivenlöffel, 6er Set

delicatessen / olives spoon, 6 pcs. set
cuchara gourmet / para aceitunas, set de 6
cuillère gourmet / à olives, set de 6



geloht
perforated
perforadas
perforées

	cm	→ cm	pcs.	Farbe / Colour	€
88598	6 x 9	27	6	■	10,00



Feinkostlöffel, 6er Set

delicatessen spoon, 6 pcs. set
cuchara gourmet, set de 6
cuillère gourmet, set de 6



	Ø cm	→ cm	pcs.	Farbe / Colour	€
88626	6	23	6	■	8,20



Feinkostlöffel, 6er Set
 delicatessen spoon, 6 pcs. set
 cuchara gourmet, set de 6
 cuillère gourmet, set de 6



	∅ cm	→ cm	pcs.	Farbe / Colour	€
88627	6	23	6		8,50



Dressinglöffel
 dressing spoon
 cuchara de aliño
 cuillère à sauce



aus Kunststoff
 plastic
 plástico
 plastique

	∅ cm	→ cm	ltr.	Farbe / Colour	€
88636	6	34	0,05		3,30
88609	6	34	0,05		3,30



Löffel
 spoon
 cuchara
 cuillère



aus Akazienholz, ideal für Reis, Gemüse...
 acacia wood, ideal for rice, vegetables...
 madera de acacia, ideal para arroz, verduras...
 bois d'acacia, idéal pour le riz, les légumes...

	cm	→ cm	€
00599	9 x 6,5	23,5	4,90



Löffel „GREEN BAMBOO“
 spoon
 cuchara
 cuillère



	cm	→ cm	€
84648	6 x 4,5	20	2,00

	∅ cm	→ cm	€
84649	6	21	2,40



Schneebeesen
whisk
batidor
fouet professionnel



	Drähte / wires	→ cm	€
88710	8	55	22,00



Schneebeesen
whisk
batidor
fouet



	Drähte / wires	→ cm	€
00744	8	28	6,60
00745	8	33	6,60
00746	8	38	8,50
00747	8	43	9,70
00740	8	48	10,00



Kesselbesen XXL
large whisk
batidor gigante
fouet géant



	Drähte / wires	Ø cm	→ cm	€
88675	8	2,3	125	89,00

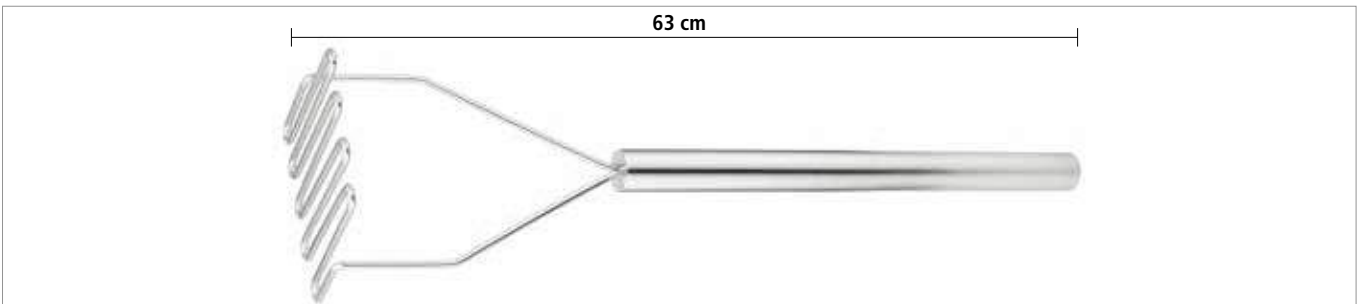

Kartoffelstampfer XXL
masher
machacador
pilon



	cm	↑ cm	Draht / wire Ø mm	€
88008	16 x 13	63	6	30,00



Spargelschäler „ORANGE“
 asparagus knife / asparagus peeler
 pelador de espárragos
 peleur à asperges



schält Spargel sparsam und gleichmäßig, mit Stellschraube für variable Schneiddicken
 peels asparagus curt and consistant, with adjustable screw to change the thickness of peeling
 pela los espárragos uniformemente, tornillo para regular el grosor del pelado
 pèle les asperges uniformément, avec vis de réglage pour l'épaisseur des pelures

	→ cm	€
88822	22	8,70



Kugelausstecher - doppelt „ORANGE“
 melon baller - double
 vaciador doble de bola
 moule à boule double



zum Formen von Kugeln aus Obst, Gemüse oder Butter, Edelstahl mit geschärften Rändern
 to form balls out of fruits, vegetables, butter, etc., stainless steel with sharpened edge
 para hacer bolas con frutas, verduras, mantequilla, etc. acero inoxidable con borde afilado
 pour faire des boules de fruits, légumes, beurre, etc. inox, bord affûté

	Ø cm	→ cm	€
88810	2,2 + 2,5	16,5	6,20
88811	2,2 + 3,0	17	6,30



Kugelausstecher „ORANGE“
 melon baller
 vaciador de melón redondo
 moule à boule ronde simple



zum Formen von Kugeln aus Obst, Gemüse oder Butter, Edelstahl mit geschärften Rändern
 to form balls out of fruits, vegetables, butter, etc., stainless steel with sharpened edge
 para hacer bolas con frutas, verduras, mantequilla, etc. acero inoxidable con borde afilado
 pour faire des boules de fruits, légumes, beurre, etc. inox, bord affûté

	Ø cm	→ cm	€
88814	3	16	3,60
88816	2,2	15,5	3,50
88818	1,5	15	3,50



Ziseliermesser „ORANGE“
 canele / decorating knife
 cuchillo de decoración cincelador
 couteau zesteur cannelé



zum Einritzen von Linien und Mustern in hartschaliges Obst und Gemüse, zum Schälen von Zitrusfrüchten, Edelstahl mit geschärften Rändern
 to score lines or design in hard fruits and vegetables, to peel citrus fruits, stainless steel with sharpened edge

para esculpir líneas o hacer dibujos sobre frutas o verduras, bastante duras para pelar cítricos, acero inoxidable con borde afilado

pour découper des lignes et motifs sur fruits et légumes à peau dure ou pour peler les zestes des citrons ou oranges, inox, bord affûté

	→ cm	€
88820	15	3,00



Fadenschneider / Zester „ORANGE“

decorator / zester
cuchillo de decoración cincelador
couteau zesteur



zum Abziehen von feinsten Schalenstreifen, ideal zum Dekorieren von Torten und Desserts
to peel off very fine stripes of paring, these stripes are ideal to decorate desserts, cakes, etc.
para pelar tiras muy finas, ideal para decorar postres, tartas, etc.
pour couper en lanières fines, idéal pour la décoration de gâteaux et desserts, etc.

	Ø cm	→ cm	€
88823	0,2 + 0,5	14,5	3,50
88824	0,2	15	3,20



Ziseliermesser „ORANGE“

canele / decorating knife
cuchillo de decoración cincelador acanalado
couteau zesteur cannelé



zum Einritzen von Linien und Mustern in hartschaliges Obst und Gemüse, Edelstahl mit geschärften Rändern
to score lines or design in hard fruits and vegetables, stainless steel with sharpened edge
para dibujar líneas en frutas o verduras de piel dura, acero inoxidable con borde afilado
pour découper des lignes et motifs sur fruits et légumes à peau dure ou pour peler les zestes des citrons ou oranges, inox, bord affûté

	→ cm	€
88826	15	3,50



Sparschäler „ORANGE“

peeler
pelador
peleur



für Links- und Rechtshänder geeignet, mit zwei starren Klingen aus extra geschärftem + gehärtetem Edelstahl
useable left- and right handed, with 2 inflexible blades made out off sharpened, extra hardened stainless steel
para diestros y zurdos, con 2 cuchillas rígidas inox afiladas y muy resistentes
pour gauchers ou droitiers, 2 lames rigides affûtés en inox extra-résistant

	→ cm	€
88827	17	2,30



Orangenschäler „ORANGE“

orange peeler
pelador de naranjas
peleur à oranges



zum Einritzen von Linien in hartschaligen Zitrusfrüchten, zum Schälen von Zitrusfrüchten, ohne das Fruchtfleisch zu verletzen, Edelstahl mit Ziselierhaken
to score lines and design hart fruits and vegetables, to peel fruits without bashing the pulp, stainless steel with hook
para dibujar líneas en frutas y verduras de piel dura para pelar cítricos sin dañar la pulpa, acero inoxidable con gancho
pour découper des lignes et motifs sur fruits et légumes à peau dure ou pour peler les citrons ou oranges sans endommager la pulpe, inox, bord affûté

	→ cm	€
88828	17,5	3,10



Pendelschäler „ORANGE“

swivel peeler
pelador reversible
éplucheur droitier/gaucher



für Links- und Rechtshänder geeignet, mit 2 beweglichen Klingen
suitable for right and left handed, with 2 flexibles blades
apto para zurdos como para diestros, con 2 hojas flexibles acero inoxidable
adapté pour droitiers ou gauchers, lame inox flexible

	→ cm	€
88849	19	3,80



Pendelschäler „ORANGE“

swivel peeler
pelador reversible
éplucheur droitier/gaucher



für Links- und Rechtshänder, ideal für das Schälen von Tomaten, mit 2 beweglichen Klingen
suitable for right and left handed, ideal to peel tomatoes, with 2 flexibles blades
apto para diestros y zurdos, ideal para pelar tomates, con 2 hojas flexibles
pour gauchers ou droitiers, idéal pour peler les tomates, 2 lames flexibles

	→ cm	€
88850	16,5	3,70



Cocktailmesser

bar knife
cuchillo para cóctel
couteau cocktail



mit 2 Zinken zum Aufspießen von Zitrusseiben
with 2 prongs to pick up slices of lemon
con 2 dientes para pinchar las rodajas de limón, etc.
avec 2 dents pour les rondelles de citron et autres décorations

	→ cm	€
88846	21	3,80



Pizzateigschneider „ORANGE“

pizza cutter
cortador de pizza
roulette à pizza



zum einfachen Zerteilen von Pizza
to cut pizza easily
para cortar pizza fácilmente
pour une coupe facile de la pizza

	Ø cm	→ cm	€
88829	6	18,5	4,10



Pendelschäler „ORANGE“

swivel peeler
pelador lama pivotante
peleur lame pivotante



zum schnellen und sparsamen Schälen von Obst und Gemüse, mit beweglicher Klinge
to peel fruits and vegetables with flexible blade
para pelar frutas y verduras con hoja flexible
pour couper des fruits et légumes avec lame flexible

	→ cm	€
88834	17	4,30



Entstieler / Entkerner „ORANGE“

tomato corer
quita-rabillo de tomate
équeuteur à tomates



zum einfachen Entfernen des Tomatenstiels, aus Edelstahl mit gezackter Krone
to remove the peduncles from tomatoes in one movement, can be used to remove the pulp of the tomato
ideal para cortar el rabo de los tomates de 1 gesto, o para hacer bolas de pulpa de tomate, inox, dentado
pour ôter la queue de la tomate en 1 seul geste ou pour former des boules avec la pulpe, inox, dentelé

	cm	→ cm	€
88835	2 x 2	15	3,70



Apfelentkerner „ORANGE“

apple corer
descorazonador de manzana
vide-pomme



durch leichtes Drehen kann das Kerngehäuse von Äpfeln, Birnen und anderen Früchten sorgsam herausgeholt werden, Edelstahl mit geschärften Rändern
with a light turn cores of apples, pears and other fruits can be cut off easily, stainless steel with sharpened edge
para descorazonar muy fácilmente manzanas, peras y otras frutas
pour évider facilement les pommes, poires ou autres fruits

	Ø cm	→ cm	€
88836	2,2	21	2,70
88837	1,6	18,5	2,60



Austernöffner „ORANGE“

oyster knife
abre ostras
couteau à huîtres



zum einfachen Aufbrechen von Austern, mit Fingerschutz, Edelstahl mit geschärften Rändern
to open oysters easily, with guard, stainless steel with sharpened edge
para abrir ostras fácilmente con protección para los dedos, acero inoxidable con punta afilada
pour ouvrir facilement les huîtres avec protection pour les doigts, inox, pointe affûtée

	→ cm	€
88839	14,5	6,00



Austernmesser „ORANGE“

oyster knife
abre ostras
couteau à huîtres



Edelstahl-Klinge zum Einstechen in die Schale, mit Fingerschutz
to open oysters easily, with guard
para abrir ostras fácilmente con protección para los dedos
pour ouvrir facilement les huîtres avec protection pour les doigts

	→ cm	€
88840	15	3,40



Dekoriermesser „ORANGE“
decorating knife „cannelé“
cuchillo acanalador
couteau cannelé



gezahnte Klinge aus geschärftem Edelstahl
serrated sharpened blade, stainless steel
hoja de sierra afilada, acero inoxidable
lame inox microdentée

	→ cm	€
88843	19	4,90



Grapefruitmesser „ORANGE“
grapefruit knife
cuchillo para pomelo
couteau à pamplemousse



zum Filetieren von Zitrusfrüchten, inkl. Ziselierhaken zum Einritzen der Schale,
Edelstahl mit beidseitigem Sägeschliff

to fillet citrus fruits incl. sharpened hook, to open the paring,
stainless steel serrated on both sides

para cortar la pulpa del pomelo, hoja curvada dentada por ambos lados para zurdos
y diestros, final en punta para pinchar, inox

lame fine recourbée microdentée des 2 côtés pour droitiers/gauchers, coupe aisément
la chair du fruit et la lame en pointe permet de la piquer, inox

	→ cm	€
88841	21	4,40



Tourniermesser „ORANGE“
paring knife
cuchillo curvado
couteau d'office bec d'oiseau



Klinge in Schnabelform, Klinge passt sich Rundungen perfekt an

with curved blade, blade adaptes perfect to curves

con hoja curva, acero inoxidable, hoja perfecta para productos redondos

lame inox, idéale pour produits ronds

	→ cm	€
88844	17,5	3,80



Gemüsemesser „ORANGE“
paring knife
cuchillo mondador
couteau d'office



zum schnellen Schälen von Gemüse

to cut vegetables and fruits quickly

para cortar frutas y verduras con rapidez, acero inoxidable

lame inox, idéale pour la coupe rapide de fruits et légumes

	→ cm	€
88845	21	3,80



Käsehobel „ORANGE“

cheese slicer
rebanador de queso
couteau tranche-fromage

zum Schneiden von dünnen Käsescheiben

to cut thin slices of cheese
para cortar lonchas finas de queso
pour couper de fines tranches de fromage



	→ cm	€
88853	21,5	4,90



Apfel- / Zwiebelteiler

apple / onion divider
porcionador de manzana / -cebolla
coupe-pomme ou oignon en quartiers

stabile Profiausführung, Klingen aus gehärtetem, geschärftem Klingenstahl, geeignet für Früchte max. Ø 10 cm

heavy gauge, extra sharpened steel blades, max. Ø 10 cm
aluminio fundido de alta calidad, cuchillas de acero afilado extra max. Ø 10 cm
fonte d'aluminium, qualité extra, lames inox affûtées, Ø 10 cm



	cm	↑ cm	€
88854	11 x 17	4,5	7,60



Flambierbrenner

chefs blow torch
soplete de cocina para flambear
chalumeau de cuisine

mit handelsüblichem Feuerzeuggas auffüllbar, Flamme einstellbar bis ca. 1300° C, Brenndauer von min. 60 Minuten

to be filled with commercial lighter gas, flame adjustable up to approx. 1300° C, burning time of at least 60 minutes

rellenable con gas de mechero comercial, llama ajustable hasta 1300 ° C, tiempo de combustión de al menos 60 minutos

rempli avec gaz pour briquet commercial, flamme réglable jusqu'à 1300 ° C, temps de combustion d'au moins 60 minutes



	Ø cm	↑ cm	€
77315	4,5	16,5	29,00



Streichpalette „BLUE“

spatula
espátula
spatule



flexible Edelstahl-Klinge, rutschfester Griff, hitzebeständig
flexible blade stainless steel, non-slip handle, heat-resistant
hoja flexible acero inoxidable mango polipropileno termoresistente anti-deslizante
lame inox flexible, manche antiglisse en polypropilène thermorésistant

	cm	→ cm	€
88920	35 x 5	48,5	8,20
88921	30,5 x 4,5	43,5	7,20
88922	25 x 4	38,0	6,60
88923	20 x 3	33,5	5,60



Winkelpalette „BLUE“

spatula
espátula
spatule



flexible Edelstahl-Klinge
flexible blade stainless steel
hoja flexible acero inoxidable
lame inox flexible

	cm	→ cm	€
88928	17 x 5	30	5,90



Gebäckpalette „BLUE“

pastry spatula
paleta pastelera
spatule pâtissière



flexible Edelstahl-Klinge
flexible blade stainless steel
hoja flexible acero inoxidable
lame inox flexible

	cm	→ cm	€
88932	17 x 7,5	29,5	6,40



Wender „BLUE“

turner
espátula
spatule



flexible Edelstahl-Klinge
flexible blade stainless steel
hoja flexible acero inoxidable
lame inox flexible

	cm	→ cm	€
88933	15 x 6	27,5	5,20



Winkelpalette „BLUE“

turner
espátula
spatule

flexible Edelstahl-Klinge
flexible blade stainless steel
hoja flexible acero inoxidable
lame inox flexible



	cm	→ cm	€
88935	34 x 5	47,5	8,40
88937	24 x 4	36	6,20
88938	18,5 x 3	32	5,50



Wender „BLUE“

turner
espátula
spatule

flexible Edelstahl-Klinge
flexible blade stainless steel
hoja flexible acero inoxidable
lame inox flexible



	cm	→ cm	€
88939	24 x 7,5	37,5	7,90



Wender „BLUE“

turner
espátula
spatule

perforiert, flexible Edelstahl-Klinge
perforated, flexible blade stainless steel
hoja flexible inox agujereada
lame ajourée inox flexible



	cm	→ cm	€
88940	24,5 x 7,5	37,5	8,20



Wender „BLUE“

turner
espátula para plancha
spatule

flexible Edelstahl-Klinge
flexible blade stainless steel
hoja flexible acero inoxidable
lame inox flexible



	cm	→ cm	€
88941	20 x 7,5	33	7,00
88942	15 x 9	28	6,90



Spachtel / Schaber „BLUE“

scraper
espátula plancha
spatule coudée spéciale grill

starre Edelstahl-Klinge
rigid blade stainless steel
hoja rígida acero inoxidable
lame inox rigide



	cm	→ cm	€
88929	11 x 10	25	6,50



Wender „BLUE“

turner
espátula
spatule

geschlitzt, flexible Edelstahl-Klinge
slotted, flexible blade stainless steel
hoja flexible inox agujereada
lame ajourée inox flexible



	cm	→ cm	€
88944	17 x 8,5	30	5,20



Spachtel / Fettabstecher „BLUE“

scraper
espátula plancha
spatule coudée spéciale grill

starre Edelstahl-Klinge
rigid blade stainless steel
hoja rígida de acero inoxidable
lame rigide inox



	cm	→ cm	€
88946	17 x 10	30	7,90
88947	15 x 7,5	28	6,50



Aufstrichmesser „BLUE“

sandwich knife
cuchillo para untar
couteau à tartiner

flexible Edelstahl-Klinge
flexible blade stainless steel
hoja flexible acero inoxidable
lame inox flexible



	cm	→ cm	€
88948	8,5 x 3	18,5	2,30



Teigschaber / Abstecher „BLUE“

dough scraper
corta pasta
coupe-pâte

starre Edelstahl-Klinge
rigid blade stainless steel
hoja rígida de acero inoxidable
lame rigide inox



	cm		€
88930	15,5 x 8		4,40



Pizzaschneider „BLUE“

pizza cutter
cortador de pizza
coupe-pizza

ergonomischer Griff
ergonomic handle
mango ergonómico
manche ergonomique



	Ø cm	→ cm	€
88949	10	20	5,80



Pizzaschneider „PRO“

pizza cutter
cortador de pizza
coupe-pizza

ergonomischer Griff
ergonomic handle
mango ergonómico
manche ergonomique



	Ø cm	→ cm	€
88727	10	25	9,60



Wender „PRO“

turner
espátula
spatule

flexible Edelstahl-Klinge
flexible blade stainless steel
hoja inox flexible
lame inox flexible



	cm	→ cm	€
88701	12 x 8,7	29	12,00



Passiersieb

strainer
colador
passoire



feines Siebgewebe mit ca. 6 Löchern pro 1 cm²
fine mesh with 6 holes per 1 cm²
malla fina con 6 agujeros por 1 cm²
toile fine avec 6 trous pour 1 cm²

	Ø cm	↑ cm	Stiellänge → cm	€
88617	26	12	28	44,00
88618	30	17	28	54,00

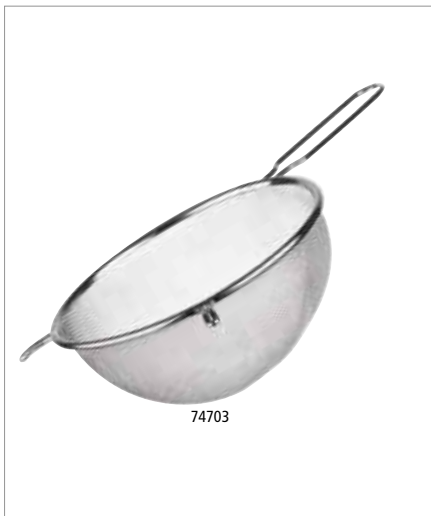

Passiersieb

strainer
colador
passoire



feines Siebgewebe mit ca. 6 Löchern pro 1 cm²
fine mesh with 6 holes per 1 cm²
malla fina con 6 agujeros por 1 cm²
toile fine avec 6 trous pour 1 cm²

	Ø cm	↑ cm	Stiellänge → cm	€
74700	14	5,0	16	7,40
74701	16	6,0	16	9,50
74702	18	7,5	16	12,80
74703	20	8,5	16	14,00
74705	24	11,0	17	16,00
74706	26	11,0	17	19,00

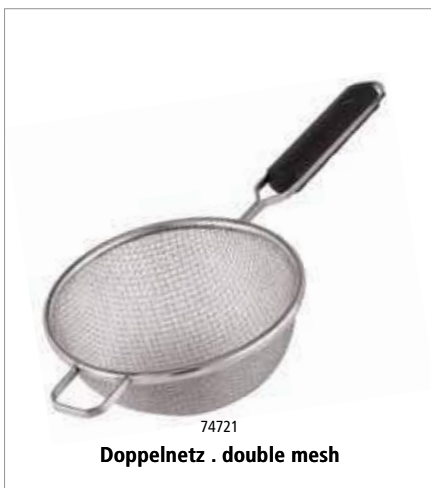

Passiersieb

strainer
colador
passoire



mit Doppelnetz, Netz außen: ca. 2 Löcher pro 1 cm, Netz innen: ca. 5 Löcher pro 1 cm
with double mesh, outer mesh about 2 holes per cm, inner mesh about 5 holes per cm
con malla doble, malla exterior aprox. 2 agujeros /cm, interior aprox. 5 agujeros /cm
avec double étamine, extérieure env. 2 trous/cm, intérieure environ 5 trous/cm

	Ø cm	↑ cm	Stiellänge → cm	€
74721	20	8	18	13,00
74722	24	10	28	20,00



Passiermühle

moulin / sieve
molino de grosellas
presse-groseilles

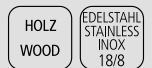

Rolle Buchen-Holz versiegelt, ca. 10 Löcher pro 1 cm²
wood-piece beech, 10 holes per 1 cm²
bola ovalada de haya, 10 agujeros por 1 cm²
boule ovale en hêtre, 10 trous pour 1 cm²

	Ø cm	↑ cm	Stiellänge → cm	€
88607	20	10	19	20,00



Back- / Frittierlöffel

skimmer / spider
espumadera para fritos
écumoire à friture

elektropoliert, sehr stabile Ausführung
electro polished, heavy gauge
electro pulido, alta calidad
poli électrolythique, qualité extra



	Ø cm	→ cm	€
74402	16	33,5	17,00
74403	18	33,5	19,00
74404	20	33,5	21,00



Pommes-Frites Abfüll-Schaufel

chip bagger
recogedor para patatas fritas
pelle à frites

matt poliert, Stiel 14 cm
satin polished finish, handle 14 cm
pulido satinado con asa, mango de 14 cm
mat, avec anse, manche 14 cm



	cm	↑ cm	€
88019	23 x 21	5,5	12,80



Pommes-Frites-Seiher

fry dripping tray
escurridor de fritos
égouttoir à friture

herausnehmbarer Locheinsatz, mit Handgriff
removable drainer, with handle
fondo de colador desmontable, con asa
fond démontable, avec poignée



	Ø cm	↑ cm	€
00785	39	19	28,00



Salzstreuer

salt shaker
salero
salière

Pommes-Frites Streuer mit Schraubkappe
for french fries, cover to screw
para patatas fritas, tapa de rosca
pour les frites, couvercle à visser



	Ø cm	↑ cm		€
00772	8	17	stainless steel	11,40
00779	8	17	aluminium	8,90



Gazespitzsieb

conical strainer with wire gauze
colador chino de malla
chinois renforcé avec maille fine

hochglanzpoliert, mit rundem Hohlgriff, ca. 9 Löcher pro 1 cm²
mirror polished finish, 9 holes per 1 cm²
pulido acabado brillante, mango hueco, 9 agujeros por 1 cm²
brillant, manche creux, 9 trous pour 1 cm²



	Ø cm	↑ cm	→ cm	€
88718	20	15	24	35,30
88717	24	19	24	42,60



Spitzsieb

conical strainer
colador cónico
chinois

mit Lochung Ø 1,5 mm, auch in der Kegelspitze, mit Flachstiel, mit Stützstiel zum Einhängen in den Topfrand

with Ø 1,5 mm holes (including the tip), with flat handle, with supporting hook
con agujeros finos de Ø 1,5 mm (incluída la punta), con mango plano y gancho
perforations fines 1,5 y compris à la pointe, manche plat et crochet



	Ø cm	↑ cm	→ cm	€
00771	23	18	16,5	22,40



Likör- und Fondanttrichter

confectionery funnel
embudo dosificador
entonnoir à piston

ergonomischer Griff aus Kunststoff, mit 3 Düsen 2, 4, 6 mm, inkl. Ständer u. Auffangschale
ergonomic plastic handle, with 3 different nozzles 2, 4, 6 mm, incl. wire rack a. dripping dash
mango ergonómico con 3 boquillas, 2, 4, 6 mm, incl. pie de alambre y bandeja recoge gotas
manche plastique ergonomique, 3 douilles de 2, 4 et 6 mm, inclut pied avec ramasse-gouttes



	Ø cm	↑ cm	ltr.	€
77338	20	34	1,5	88,00



Gemüsehobel, Mandoline

mandolin
mandolina
mandoline

mit 7 verschiedenen Klingen (Breite 10 cm), Anti-Rutsch-Gestell, Schutzabdeckung

with 7 interchangeable blades (width 10 cm), non-slip folding stand, safety guard
con 7 cuchillas intercambiables (corte 10 cm), pie plegable anti-deslizante, carro de seguridad
7 peignes interchangeables (largeur 10 cm), pied repliable anti-glisse, chariot



	cm	↑ cm	€
88688	40,5 x 12	5 / 25	72,00



- A** 7 verschiedene Klingen
7 interchangeable blades
- B** Praktische Transportbox
Practical transport box



74731

Wasserbadschüssel
 bain marie bailing bowl
 cazo para baño maría
 récipient bain-marie

hochglanzpoliert, mit Drahtgriff Ø 5 mm
 mirror polished finish, with wire handle Ø 5 mm
 inox pulido brillante, mango varilla Ø 5 mm
 inox brillant, manche fil épaisseur Ø 5 mm

	Ø cm	↑ cm	→ cm	ltr.	€
74731	18	9	15	1,5	12,00
74732	20	10	15	2.0	15,00



30054

Mess- / Universalkanne
 graduated jug
 jarra medidora universal
 pichet mesureur universel

matt poliert, mit Maßskalierung innen
 satin polished finish, with stamped liter scale inner
 acabado satinado, con graduación en el interior
 mat, graduations à l'intérieur

	Ø cm	↑ cm	ltr.	€
30054	12	13	1	18,00
30055	14	17	2	31,00

Messbecher
 graduated jug
 jarra graduada
 pichet gradué

außen hochglanzpoliert, innen matt poliert, mit Maßskalierung außen
 outside mirror polished finish, inside satin polished finish, with stamped liter scale
 exterior pulido brillante, interior satinado con escalado en litros
 extérieur brillant, intérieur satiné, graduation en litres

	Ø cm	↑ cm	ltr.	€
30045	10	14	1	11,80



30048

30046

30047

30049

Messbecher
 measuring cup
 jarra graduada
 pichet gradué

mit geschlossenem Griff, mit geprägter Maßskalierung außen, l- und ml-Liter-Einteilung
 with handle, with stamped printed liter and ml scale
 con asa, graduación ml.
 avec anse, graduation en ml.

	Ø cm	↑ cm	ltr.	€
30046	9,5	14	0,5	2,90
30047	12	17	1	3,90
30048	15,5	21	2	6,90
30049	17,5	23,5	3	8,90
30057	20,5	27,5	5	10,50



Schaumspeiseringe, 5er Set

mousse ring, 5 pcs. set
juego aros para emplatar o para semifríos
jeu de cercles à mousse inox, ronds



5-teilig: 4 Formen + 1 Verdichter, matt poliert, fugenlos

5 pcs. set: 4 shapes and 1 pusher, satin polished finish, seamless

juego de 5 piezas: 4 aros redondos y 1 pulsador, para dar forma, satinado sin soldadura
jeu de 5 pièces: 4 cercles et 1 poussoir. Idéal pour dressage sur assiette ou mousse, mat satiné, sans soudure

	Ø cm	↑ cm	€
00110	6	4,5	16,00
00113	8	4,5	17,00



Schaumspeisering

mousse ring
aro redondo para semifríos
cercle à mousse rond



matt poliert, fugenlos

satin polished finish, seamless

acabado satinado sin soldadura

mat satiné, sans soudure

	Ø cm	↑ cm	€
00098	6	4,5	2,90
00099	7	4,5	3,20
00092	8	4,5	3,40
00093	10	4,5	4,70
00094	12	4,5	6,20



Tortenring

cake setting ring
aro de tarta
cercle à gâteaux



stufenlos verstellbar

adjustable

ajustable

ajustables

	Ø cm	↑ cm	€
00040	16,5 - 32	7	ohne Griff / without handle 7,80



Backform

baking pan
marco pastelero
forme à gateaux



stufenlos verstellbar, aus flexiblem Edelstahl

adjustable

ajustable

ajustable

	cm	↑ cm	€
00042	19 x 28 - 34 x 54	5	16,40



Tortenheber

cake lifter
pala / bandeja para tarta
pelle / plateau à gâteau



spiegelblank, bessere Handhabung durch ergonomischen Griff
shiny surface, easy handling, ergonomic handle
superficie brillante, manejo fácil, ergonómico
brillant, pratique, sûr et ergonomique

	Ø cm	€
00045	30	9,90



00106

Dariolformen, 2er Set

dariol moulds, 2 pcs. set
juego 2 flaneras
jeu de 2 moules à flan



hochglanzpoliert
mirror polished finish
acabado brillante
brillant

	Ø cm	↑ cm	ltr.	€
00105	5,6	4,7	0,075	4,20
00106	6,3	4,5	0,1	5,00
00107	7,0	3,5	0,1	5,80
00108	8,5	5,0	0,2	6,40



Tortenteiler

cake marker
marcador de pasteles
disque à marquer les parts



elfenbein, beidseitig verwendbar, mit 2 Griffen, 12 oder 16 Segmente
ivory-coloured, double sided, with 2 handles, 12 or 16 pcs.
polipropileno, color marfil, doble cara, con 2 asas, 12 o 16 porciones
polypropylène, couleur ivoire, 2 faces, avec 2 poignées, 12 ou 16 parts

	Ø cm	↑ cm	€
88060	26,5	2,5	6,20



13377

Ausstellblech / Thekenblech

display tray
bandeja pastelera
plaque pâtissière



hitzebeständig bis 230°C
heat-resistant up to 230°C
resistente al calor hasta 230 °C
résistant à la chaleur jusqu'à 230°C

	cm	↑ cm	€
13377	40 x 25	2	7,60
13378	48 x 32	2	9,40
13379	60 x 40	2	12,00



Mehlschaufel

scoop
pala
pelle à farine



stehende Schaufel, auch für Flüssigkeiten geeignet
standing scoop, also applicable for liquids
pala, ápto también para líquidos
adaptée pour poudres et liquides

	cm	↑ cm	ltr.	Farbe / Colour	€
00610	25 x 9	4,5	0,25	White	2,30
00611	31 x 12	5,5	0,5	White	2,80
00612	35 x 13	6	0,7	White	4,10



Seiher

strainer
colador
passoire



mit 2 Muschelgriffen
with 2 shell shaped grips
con dos asas
à 2 anses moulées

	Ø cm	↑ cm	€
00780	36	19	9,40



Backhandschuhe

baking mittens
manoplas de panadero
gants de boulanger

Leder, gefüttert, Einheitsgröße, mit Stulpen, extrem hitzebeständig bis 250°C
leather, inner lining, one size, with cuffs, extremely heat resistant up to 250°C
cuero interior forrado, talla única, resiste a temperaturas hasta 250°C
cuir intérieur doublé, taille unique, résiste à maxi 250°C

	→ cm	€
88090	45	29,00



Pizzaschaufel

pizza peel
pala de pizza
pelle à pizza



	cm	→ cm	€
88080	35 x 30,5	90	34,00
88081	35 x 30,5	130	41,00



Pinsel

brush
brocha
pinceau pâtissier



weißgebleichte, naphtalinfreie Borsten, temperaturbeständig von -40°C bis +95°C
bleached bristles, heat-resistant from -40°C to +95°C
cerdas blanqueadas, resistencia térmica -40°C hasta +95°C
soies blanches sans naphtaline, résistance de -40°C à +95°C

	cm	→ cm	€
77350	4 x 1	23,5	6,20
77352	6 x 1	24	9,00



Gewürzkasten

condiment container
especiero
boîte à épices ou ingrédients



matt poliert, 4 herausnehmbare Einsatzschalen je 0,5 l, Scharnierdeckel aus Polycarbonat
satin polished finish, 4 removable inserts each 0,5 l, hinged polycarbonate lid
acabado mate, cuatro contenedores en propileno, capacidad de cada uno 0,5l, tapa policarbonato alta calidad con bisagra
mat, 4 compartiments de 0,5 L en polypropilène, couvercle polycarbonate à charnières

	cm	↑ cm	litr.	€
71700	31 x 15,5	9,5	4 x 0,5	23,00

Einsatzschale / insert / contenedor 0,5 L / récipient 0,5 L

	cm	↑ cm	litr.	€
71701	14,2 x 7,5	7	0,5	3,70



2 Pressringe für Zitrone und Limette

Limetten- / Zitronenpresse

lime- / lemonpress
exprimidor de limón / lima
presse citron



	cm	↑ cm	€
93214	21 x 7	5	13,00



Limettenpresse

lime press
prensa de limón
presse citron



	cm	↑ cm	€
93189	21 x 7	5	10,00



Zitruspresse

citrus squeezer
exprimidor cítricos
presse-citron



hochglanzpoliert, 2-teilig
mirror polished finish, 2 pcs.
pulido brillante, 2 piezas
brillant, 2 pièces

	Ø cm	↑ cm	litr.	€
71431	12 / 17	10,5	0,35	12,90



Vorratsglas „WOODY“
 canister with lid
 bote con tapa
 pot en verre avec couvercle



Holzdeckel mit Silikondichtung
 wooden lid with silicone gasket

GLAS GLASS
 HOLZ WOOD
 SILIKON SILICON

Glasbehälter mit Holzdeckel, aromadichter Verschluss
 glass container, aroma-tight screw cap
 recipiente de cristal, tapa con cierre hermético para conservar el aroma
 récipient en verre, couvercle avec fermeture hermétique pour conserver l'arôme

	Ø cm	→ cm	ltr.	€
82255	14 x 14	11,0	1,0	7,80
82256	14 x 14	17,0	2,0	8,20
82257	14 x 14	21,5	2,5	8,90



Vorratsglas „CLASSIC“
 canister with lid
 bote con tapa
 pot en verre avec couvercle

GLAS GLASS
 PE POLYETHYL.

inkl. Glasdeckel mit Dichtung. Somit bleibt Ihre Ware frisch
 incl. glass lid with seal. Thus, your goods remain fresh
 incl. tapa de vidrio con junta. Por lo tanto, sus productos permanecen frescos
 y compris couvercle en verre avec joint. Ainsi, vos marchandises restent fraîches.

	Ø cm	↑ cm	ltr.	€
82250	11,5	16,0	0,9	4,90
82251	14,0	21,5	2,0	8,90
82252	18,0	26,0	4,0	14,00
82253	20,0	30,0	6,0	16,40



Vorratsglas mit luftdichtem Klappdeckel

glass with airtight cover
bote con cierre hermético
pot en verre avec fermeture hermétique



	cm	↑ cm	ltr.	€
82328	12 x 12	22	2	6,20



Vorratsglas

canister with lid
bote con tapa
pot en verre avec couvercle



Glaskugel mit Löffel, Schraubdeckel mit aromadichtem Verschluss, Edelstahl-Löffel mit magnetischem Silikongriff, 1 Stck.

tight cover, stainless steel spoon with magnetic silicone handle, 1 pc.

tapa a rosca con cierre hermético, cuchara de acero inoxidable con mango de silicona magnético, 1 pza

couvercle à vis avec fermeture hermétique, cuillère en acier inox avec manche de silicone aimanté, 1 pc.

	Ø cm	↑ cm	ltr.	€
00636	20	18	3	9,80



Vorratsglas

canister with lid
bote con tapa
pot en verre avec couvercle



Glaskugel mit Schraubdeckel, aromadichtem Verschluss, 1 Stck.

glass ball, aroma-tight screw cap, 1 pc.

bote de cristal, tapa a rosca para conservar el aroma, 1 pza

pot en verre, couvercle à vis pour conserver l'arôme, 1 pc.

	cm	↑ cm	ltr.	€
00637	12,5 x 19	18	1	7,20



Bonspieß

bill spike
pinchanotas
pique-bons



Spieße aus flexiblen Kunststoff, mit stumpfen Enden zur Unfallverhütung
spikes made of flexible plastic, with blunt ends to prevent accidents
pinchos de plástico flexible
piques en plastique flexible

	cm	↑ cm	€
88855	9 x 5,5	10,5	3,20



Bonleiste

bill rail
portafichas
barre porte-bons



matt poliert, mit Kugel-Greifsystem, zur Wandmontage geeignet, auch mit Magneten nutzbar
satin polished finish, small balls hold the bills, suited for wall fastening, can also be used with magnets
acabado satinado, con sistema de bolas para colgar las notas para fijar en la pared, puede usarse con imán
mat satiné, avec billes pour fixer sans effort tous types de fiches et papiers, peut se fixer sur plaque aimantée

	cm	↑ cm	€
88900	40 x 8	2	16,00
88901	50 x 8	2	17,40
88902	60 x 8	2	18,90



Magnet-Messerhalter

magnetic knife rack
barra magnética para cuchillos
barre aimantée pour couteaux



mit 2 Magnetschienen und Haken, aus massivem Kunststoff, zur Wandmontage geeignet, Lieferung ohne Deko
with 2 magnet racks and hooks, strong plastic, suited for wall fastening
con 2 railes magnéticos y ganchos, plástico macizo, fijación en pared
avec 2 rails aimantés et crochets, plastique robuste, fixation murale

	→ cm	€
88910	33	7,80
88911	45	9,80
88912	60	12,00



Folien-Abreißvorrichtung, mit Abreißkante / Säge

clingfilm tear-off-dispenser
dispensador de film
dérouleur de film



mit Abreißkante / Säge-Messer, für Endlosfolie, als Tischgerät oder Wandgerät verwendbar
with saw, for endless rolls, can be fixed on the wall
con sierra para rollo de film continuo, se puede fijar en la pared
avec lame dentée pour rouleau de film, peut être fixé au mur

	cm	↑ cm		€
88288	34 x 16	9	für Folienbreite 30 cm / for film width 30 cm para film ancho 30 cm / pour film largeur 30 cm	38,00
88287	49 x 16	9	für Folienbreite 45 cm / for film width 45 cm para film ancho 45 cm / pour film largeur 45 cm	42,00



Schneidbrettständer
cutting board rack
soporte para tablas
rack pour planches à découper



für 6 Schneidbretter bis 25 mm Stärke, Lieferung ohne Deko
for 6 chopping boards up to 25 mm thickness
para 6 tablas de corte de 25 mm
pour 6 planches de 25 mm

	cm	↑ cm	€
88903	27 x 31	28	29,00



Eiswaffel-Ständer
cornet stand
soporte cucuruchos
support à cornets



matt poliert, mit 4 Löchern, 2 x Ø 31 mm + 2 x Ø 26 mm
satin polished finish, with 4 holes, 2 x Ø 31 mm + 2 x Ø 26 mm
acero inoxidable con 4 agujeros 2 x Ø 31 mm + 2 x Ø 26 mm
inox, 4 trous - 2 x Ø 31 mm + 2 x Ø 26 mm

	cm	↑ cm	€
11881	9,5 x 27,5	9	18,50



Eiswaffel-Ständer
cornet stand
soporte cucuruchos
support à cornets



mit 4 Löchern, 2 x Ø 31 mm + 2 x Ø 26 mm
with 4 holes, 2 x Ø 31 mm + 2 x Ø 26 mm
con 4 agujeros, 2 x Ø 31 mm + 2 x Ø 26 mm
4 trous, 2 x Ø 31 mm + 2 x Ø 26 mm

	cm	↑ cm	€
11894	24,5 x 9,5	9	17,60



Küchentuchständer
kitchen roll holder
porta rollo de cocina
dérouleur papier essuie-tout



	Ø cm	↑ cm	€
70303	18	31	13,90



Quetschflasche „MINI“, 4er Set

squeeze bottle, 4 pcs.
bote dosificador flexible, 4 pz.
bouteille verseuse souple, 4 pc.



mit Schraubdeckel und Verschlusskappe, ideal zum Servieren von Dressing und Saucen
with tight-screw and cap, ideal for serving dressing and sauces
tapa de rosca, con tapón, ideal para servir aliño y salsas
bouchon à vis de étanche, avec bouchon, idéal pour servir de vinaigrette et sauces

	Ø cm	↑ cm	ltr.	pcs.	€
93225	3,0	8,5	0,03	4	4,40
93226	3,5	9,5	0,05	4	4,80



Quetschflasche

squeeze bottle
bote dosificador flexible
bouteille verseuse souple



ideale Größe, um Speiseteller mit Saucen zu verzieren, mit Verschlusskappe
ideal size to garnish plates with sauces, with cap
tamaño ideal para decorar los platos con salsas o culis, con tapón
taille idéale pour la décoration sur assiette avec sauces ou coulis, avec bouchon

	Ø cm	↑ cm	ltr.	€
93154	5	18	0,2	1,30
93163	5,5	19	0,35	2,10



Quetschflasche

squeeze bottle
bote dosificador flexible
bouteille verseuse souple



	Ø cm	↑ cm	ltr.	Farbe / Colour	€
93240	7	21	0,35		1,80
93241	7	21	0,35		1,80
93242	7	21	0,35		1,80
93243	8	24,5	0,7		2,30
93244	8	24,5	0,7		2,30
93245	8	24,5	0,7		2,30



Quetschflasche

squeeze bottle
bote dosificador flexible
bouteille verseuse souple



mit Verschlusskappe
with cap
con tapón
avec bouchon

	Ø cm	↑ cm	ltr.	Farbe / Colour	€
93155	6,5	25	0,65		1,70
93156	6,5	25	0,65		1,70
93157	6,5	25	0,65		1,70



Quetschflasche

squeeze bottle
bote dosificador flexible
bouteille verseuse souple

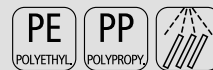

	Ø cm	↑ cm	ltr.	Farbe / Colour	€
93222	9,5	25,5	1,1		5,10
93223	9,5	25,5	1,1		5,10
93224	9,5	25,5	1,1		5,10



Dosierspender

dispenser
dispensador de salsa
doseur à sauce

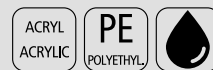

	cm	↑ cm	ltr.	€
93151	13 x 7,5	27	1,25	34,70
93150	11 x 11	27	1,35	34,70

Dosierpumpe

dosing pump / riser tube
bomba de salsa, sola
pompe à sauce



Hubvolumen 30 ml
swept volume 30 ml
cada dosis 30 ml
30 ml par dose

	Ø cm	↑ cm	€
88271	4,5	40	10,00

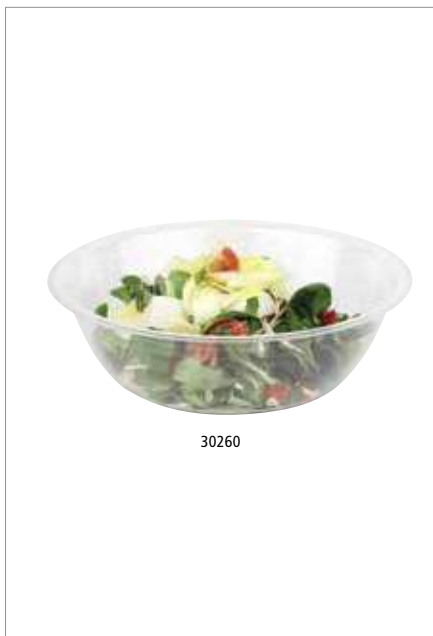

Schüssel

bowl
ensaladera
saladier



	Ø cm	↑ cm	ltr.	Farbe / Colour	€
30260	32,5	10	4		4,70
30263	40	12	8		9,40
30266	47	14,5	14		14,70



schmiedeeiserne Servierpfanne

pan wrought-iron
sartén forjada
poêle à frire forgée



mit zwei Griffen, hervorragende Brateigenschaft, Griffe und Stiele angeschweißt
with two welded handles, best bake properties, professional quality
con dos asas, excelentes propiedades de cocción, calidad profesional
2 anses, qualité professionnelle, excellente diffusion de chaleur, idéale pour la cuisson

	Ø cm	↑ cm	kg	€
73700	14 - 20	3	0,87	16,80
73701	17 - 24	3	1,15	19,30
73702	21 - 28	3,5	1,49	27,30
73703	24 - 32	3,5	1,85	41,90

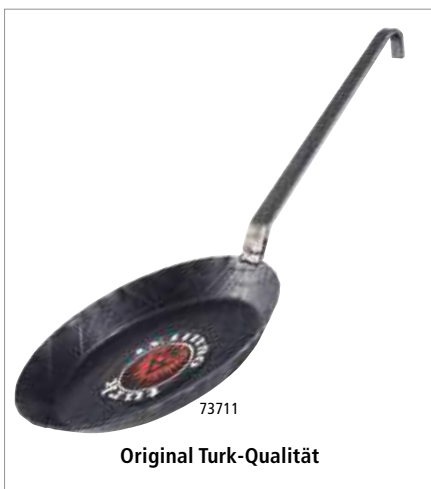

schmiedeeiserne Servierpfanne

wrought-iron pan
sartén forjada
poêle à frire forgée



mit geschmiedetem, angeschweißtem Hakenstiel, hervorragende Brateigenschaft
welded handle with hook, best bake properties, professional quality
mango soldado, con gancho al final, excelentes propiedades culinarias, calidad profesional
manche soudé à accrocher, qualité professionnelle, excellente diffusion de chaleur, idéale pour la cuisson sur tous feux, pour le four ou pour la table

	Ø cm	↑ cm	kg	€
73711	14 - 20	3	0,85	15,10
73712	17 - 24	3	1,17	17,90
73713	21 - 28	3	1,53	25,20
73714	24 - 32	3	1,99	37,80

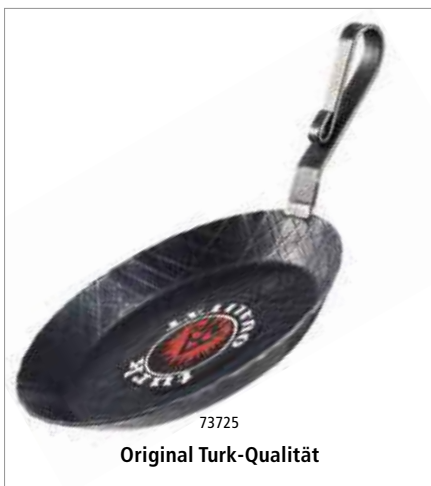

schmiedeeiserne Servierpfanne

pan wrought-iron
sartén forjada
poêle à frire forgée



mit geschmiedetem angeschweißtem gebogenem Hakenstiel, hervorragende Brateigenschaft
welded bended handle with hook, best bake properties, professional quality
con mango vuelto soldado, excelentes propiedades, calidad profesional
manche soudé replié, qualité professionnelle, excellente diffusion de chaleur

	Ø cm	↑ cm	kg	€
73725	14 - 20	3	0,87	15,70
73726	17 - 24	3	1,18	19,70
73727	21 - 28	3	1,54	27,30



Korkuntersetzer

cork mat
salvamanteles
dessous-de-plat liège



ideal für Servier- und Eisenpfannen
ideal for iron pan
ideal para servir en sartenes de chapa
idéal pour présenter les poêles forgées sur table

	Ø cm	↑ cm	€
73750	24	2	11,00



Eisenpfanne

iron pan
sartén de chapa
poêle à frire lyonnaise



schwere Ausführung, mit angeschweißtem Hakenstiel, extra hoher Rand, für den professionellen Einsatz

heavy version, with flat welded handle with eye, extra high seam, professional quality
pesada, con mango plano, borde alto, para uso profesional
qualité lourde, manche plat, bord haut, pour usage professionnel

	Ø cm	↑ cm	kg	€
73739	14,5 - 20	4	1,04	14,10
73740	17 - 24	4	1,45	17,60
73741	20,5 - 28	4,5	1,87	24,20
73742	23 - 32	5	2,41	29,10
73743	27 - 36	6	3,11	37,80



Pizzaform

pizza dish
molde de pizza
moule à pizza



Blaublech, nicht beschichtet, lange Lebensdauer, zum professionellen Pizzabacken

metal sheet, without coating, long endurance, baking pizza professional
chapa azul, sin revestimiento, muy resistente, para uso profesional, larga duración
métal, sans revêtement, très résistant, pour usage professionnel, très durable

	Ø cm	↑ cm	€
73502	18 - 16,2	2,5	2,60
73503	20 - 18,2	2,5	2,80
73504	22 - 20,2	2,5	3,10
73505	24 - 22,3	2,5	3,40
73506	26 - 24,3	2,5	3,60
73507	28 - 26,3	2,5	4,00
73508	30 - 28,3	2,5	4,60
73509	32 - 30,3	2,5	5,00
73510	36 - 34,3	2,5	5,90
73511	40 - 38,3	2,5	8,30
73513	50 - 48,4	2,5	12,70



Pizzaform

pizza dish
molde de pizza
moule à pizza



Blaublech, rechteckig, Rand umgelegt, hitzebeständig bis 260°C

blue steel baking sheet, rectangular
chapa azul rectangular, borde plgado
métal, rectangulaire, bord plié

	cm	↑ cm	€
88255	50 x 35	2,5	14,50
88256	60 x 40	2,5	19,80



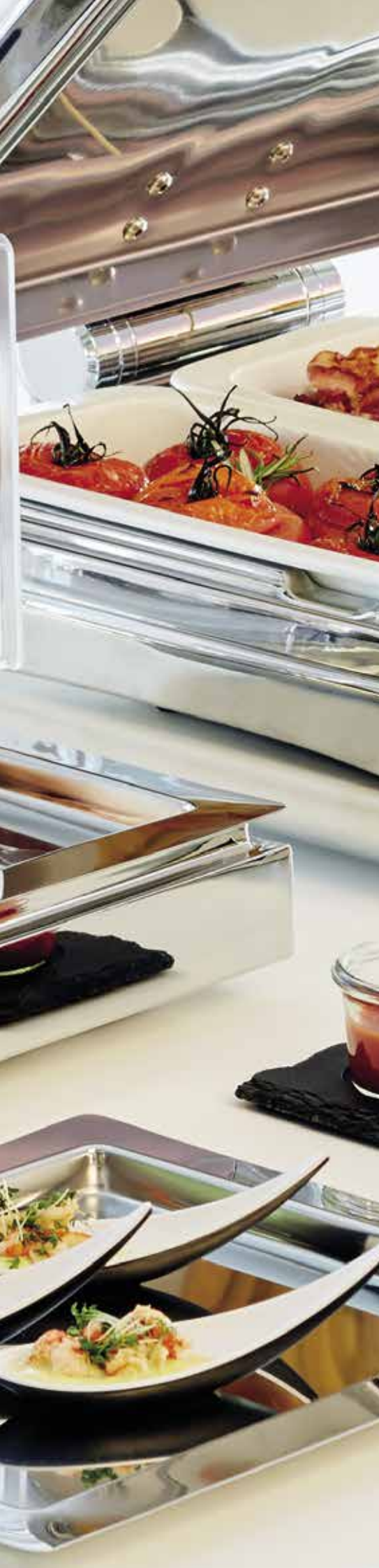

Hauben & Zubehör

covers & accessories
campanas & accesorios
cloches & accessoires

QUALITÄTSHAUBEN

11042
GN 1/1

11041
GN 1/2



NEW



11043
GN 1/3



11044
GN 2/4



11041
GN 1/2



11042
GN 1/1

GN Abdeckhaube

GN cover
GN cubierta
GN cloche



passend für GN Tablett, glasklarer Kunststoff, nahezu unzerbrechlich
suitable for GN trays, clear plastic, nearly unbreakable
apto para bandejas GN, plástico transparente, muy resistente a la rotura
pour bacs et plateaux GN, plastique transparent, très résistant à la casse

	cm	↑ cm	✂ mm	GN	€
11043 <small>NEW</small>	32,5 x 17,6	10,5	3	1/3	15,00
11044 <small>NEW</small>	53,0 x 16,2	10,5	3	2/4	20,00

	cm	↑ cm	✂ mm	GN	€
11041	32,5 x 26,5	9,5	3	1/2	20,00
11042	53,0 x 32,5	9,5	3	1/1	28,00



stapelbar
stackable



GN 1/1 Haube „HOCHSTAPLER“

GN 1/1 cover
GN 1/1 campana
GN 1/1 cloche



glasklarer Kunststoff, Tablett fixiert sich auf der Haube - kein Rutschen möglich, nahezu bruchfest
clear plastic, tray fixes itself on the cover and can not slip off, nearly unbreakable
plástico transparente, la bandeja se fija a la tapa para que no se deslice, muy resistente a la rotura
en plastique transparent, le plat se fixe sur le dessous de la cloche pour ne pas glisser, très résistant à la casse

	cm	↑ cm	GN	fits to	€
11305	53 x 32,5	9	1/1	11300, 11290, 11295	30,00



GN 1/1
GN 1/2

GN Rolltophaube

GN rolltop cover
GN campana rolltop
GN cloche rolltop



patentiert, passend für GN-Behälter, -Tablets, etc., leichtgängig auf- und zuklappbar 90°
patented, suitable for GN trays, solid quality, 90° opening
patentada, para bandejas GN, apertura 90°
brevetée, pour plateaux GN, ouverture 90°

	cm	↑ cm	GN		€
11008	53,0 x 32,5	19	1/1	vergoldeter Griff / gold plated handle pomo dorado / bouton doré	59,90
11010	53,0 x 32,5	19	1/1	verchromter Griff / chrome plated handle pomo cromado / bouton chromé	59,90
12008	32,5 x 26,5	15	1/2	vergoldeter Griff / gold plated handle pomo dorado / bouton doré	54,20
12010	32,5 x 26,5	15	1/2	verchromter Griff / chrome plated handle pomo cromado / bouton chromé	54,20



GN 1/1

GN 1/1 Rolltophaube „SUNDAY“

GN 1/1 rolltop cover
GN 1/1 campana rolltop
GN 1/1 cloche rolltop



patentiert, mit Designer-Griff, ABS verchromt, leichtgängig auf- und zuklappbar
patent, with designer handle, chrome plated, easy to open and close
patentado, asa diseñada, material ABS cromado, fácil de abrir y cerrar
breveté, poignée designee, matériel ABS chrome, ouverture et fermeture faciles

	cm	↑ cm	GN		€
11016	53,0 x 32,5	19	1/1		62,00



GN 1/1 Haube

GN 1/1 cover
GN 1/1 campana
GN 1/1 cloche



klappbar, passend für GN 1/1-Behälter, GN 1/1-Tablets, etc., nahezu bruchfest
suitable for GN 1/1 chafing dish, GN 1/1 trays, GN 1/1 pans
plegable, para cubetas GN 1/1, bandejas GN 1/1 etc., muy resistente a la rotura
pliable, pour bacs GN 1/1, plateaux GN 1/1 etc., très résistant à la casse

	cm	↑ cm	GN		€
11013	53,0 x 32,5	6	1/1		27,50



klappbar
adjustable



Rolltophaube „PURE“

rolltop cover
campana abatible
cloche basculante



verchromter Griff
chrome plated handle
pomo cromado
bouton chromé

	cm	↑ cm			€
09013	44 x 33,5	17			24,00



GN Kuppelhaube

GN cover
GN cúpula
GN cloche bombée

glasklarer Kunststoff, Griff verchromt
clear, chrome knob
transparente, asa cromada
transparente, anse chromée



	cm	↑ cm	GN		€
11021	33 x 28	17	1/2	geschlossen / totally closed cerrada / totalmente fermée	22,00
11022	33 x 28	17	1/2	mit Front-Ausschnitt / one long side cut out gran apertura frontal grande ouverture frontale	24,00
11026	54 x 33	20	1/1	geschlossen / totally closed cerrada / totalmente fermée	47,00
11027	54 x 33	20	1/1	mit Front-Ausschnitt / one long side cut out gran apertura frontal grande ouverture frontale	49,00
11028	54 x 33	20	1/1	mit seitlichem Ausschnitt one small side cut out pequeña apertura lateral petite ouverture latérale	49,00



stapelbar
stackable



Rolltophaube
rolltop cover
campana abatible
cloche basculante



glasklarer Kunststoff, leichtgängig auf- und zuklappen 90°
solid quality, to be opened 90°
plástico transparente, apertura 90°
plastique transparent résistant, ouverture 90°

	Ø cm	↑ cm		€
18388	38	20	mit verchromtem Kugelgriff / with chrome plated handle con pomo cromado / avec bouton chromé	19,40
18387	38	20	mit vergoldetem Kugelgriff / gold plated handle pomo dorado / bouton doré	19,40
18380	50	26	mit verchromtem Zylindergriff / chrome plated handle pomo cromado / bouton chromé	54,00



Frischhalte-Haube
cover
campana
cloche bombée



glasklar, Griff verchromt, schwere, stabile Ausführung
transparent, chrome knob, heavy stable quality
transparente, asa cromada, alta estabilidad
transparente, anse chromée, très stable

	Ø cm	↑ cm	fits to	€
15350	16,5	10	15130	8,90
15351	20,5	10	15131, 15141, 15136, 15271, 84241	9,90



Hauben & Zubehör



Frischhalte-Haube

cover
campana
cloche



schwere, glasklare Qualität
stable, crystal clear quality
calidad estable y transparencia cristalina
qualité stable et clarté cristalline

	Ø cm	↑ cm	fits to	€
06520	30	22	84242, 84177, 83892, 83891, 83890, 83884, 15303, 998, 975, 469, 468, 463, 462 46,	29,90



stapelbar
stackable



06512

Frischhalte-Haube

cover
campana
cloche



glasklar, schwere stabile Ausführung, stapelbar
clear, heavy stable quality, stackable
transparente, alta estabilidad, apilable
transparente, très stable, empilable

	Ø cm	↑ cm		€
06510	30	11,5		4,40
06512	30	11,5	mit verchromtem Griff / with chrom plated handle con botón cromado / avec bouton chromé	5,90



06515

Frischhalte-Haube

cover
campana
cloche



glasklar, schwere stabile Ausführung, stapelbar
clear, heavy stable quality, stackable
transparente, alta estabilidad, apilable
transparente, très stable, empilable

	Ø cm	↑ cm		€
06515	33	12,5		5,50
06517	33	12,5	mit verchromtem Griff / with chrom plated handle con botón cromado / avec bouton chromé	6,90



06501

Frischhalte-Haube

cover
campana
cloche



	Ø cm	↑ cm		€
06501	30	11		3,00
06504	30	9,5		4,90
06506	30	7		2,90



Frischhaltehauben, 2er Set

covers, 2 pcs. set
campanas, set de 2
cloches, pack de 2



	Ø cm	↑ cm	€
40752	30	11	5,90



Deckel „FLOAT“ mit Löffelaussparung

cover, with notched for spoons
tapa, con espacio para la cuchara
couvre-cle, avec encoche pour la louche



	Ø cm	↑ cm	fits to	€
83920	20,5	1,3	83908, 83909	8,20



Deckel „PURE“ mit Löffelaussparung

cover with notched for spoons
tapa con espacio para la cuchara
couvre-cle avec encoche pour la louche



	cm	↑ cm	fits to bowls	€
83600	19 x 19	1,5	84410, 84417, 84422, 83409, 83572, 84468, 83573, 84429, 84244, 84553	8,00
83601	25 x 25	1,5	84408, 84418, 84423, 83469, 83574, 83575, 83408, 84430, 84245, 84561, 84562, 84563, 84554	10,50
83602	32 x 32	1,5	84425, 84427	12,00



stapelbar
stackable



Deckel „FLOAT“ mit Löffelaussparung

cover, with notched for spoons
tapa, con espacio para la cuchara
couvre-cle, avec encoche pour la louche



	cm	↑ cm	fits to	€
83921	19 x 19	1,3	83916, 83917	8,20
83922	25 x 25	1,3	83918, 83919	10,40



10890

Frischhaltedeckel

airtight cover
tapa hermética
couvrete hermétique



mit Silikondichtung, für luftdichtes Verschließen, Lebensmittel bleiben lange frisch
with silicone sealing ring, bowls closed airtight, to keep food fresh for a long time
junta de silicona para cerrar herméticamente y mantener los alimentos frescos más tiempo
joint de silicone pour fermeture hermétique et meilleure conservation des aliments

	Ø cm	fits to	€
10890	14	11865, 83700, 83701	10,50
10887	23	11875, 11846, 11848, 83702, 83703	19,00



zwei Öffnungspositionen des Deckels
two opening positions of the lid

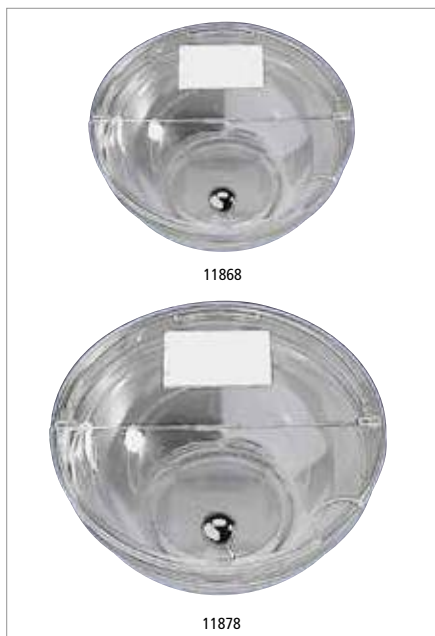

11868

11878

Schutzdeckel mit Löffelaussparung

cover
tapa
couvrete



glasklar, klappbar, mit 10 Beschriftungs-Schildern
transparent, with 10 cards for inscription
plástico transparente, con 10 etiquetas para inscripción
plastique transparent, avec 10 étiquettes pour inscription

	Ø cm		€
11868	14,5	mit verchromtem Griff / chrome plated handle botón cromado / bouton chromé	10,40
11878	23,5	mit verchromtem Griff / chrome plated handle botón cromado / bouton chromé	11,40

Schilder, 10er Set / signs, 10 pcs. set / set de 10 cartelitos / set de 10 étiquettes

	fits to	€
12879	11867, 11868	4,90
11879	11877, 11878	4,60

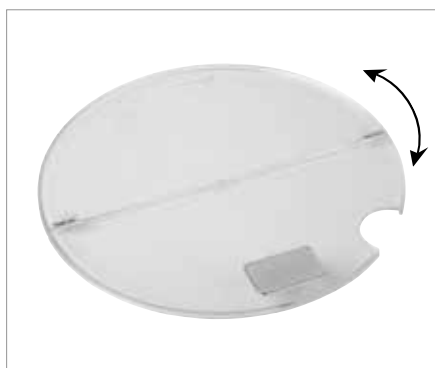

Deckel klappbar mit Löffelaussparung

cover hinged
tapa con bisagra
couvrete avec charnière



glasklar, mit Designer-Griff, verchromt, ohne Beschriftungsschild
clear, with designer handle, chrome plated, without card for inscription
transparente, con pomo de diseño cromado, sin tarjetas para inscripción
transparent, avec bouton chromé de design, sans étiquette pour inscription

	Ø cm	€
10889	23,5	10,50



11875

Schale

bowl
cuenco
bol



	Ø cm	↑ cm	ltr.	pcs	€ / pc.
11875	23	10,5	2,5	6	4,20
11865	14	3,5	0,5	6	2,20
11866	7,5	6,5	0,09	36	1,40
11859	6,0	2,5	0,05	36	1,30



Kühlakku

cooler
 acumulador de frío
 accumulateur de froid



gefüllt mit Kühlflüssigkeit, nicht giftig, einfach im Gefrierfach einfrieren, unbegrenzt wiederverwendbar
 freeze it in freezer, non toxic, filled with freezer-liquid, boundless reusable
 se enfría en el congelador, no tóxico, se puede reutilizar sin límite
 liquide eutectique qui accumule froid une fois dans le congélateur, non toxique, réutilisable sans limites

	Ø cm	↑ cm	Farbe / Colour	€
10777	15	2,5		5,00
10781	10,5	2,5		3,00
10661	10,5	2,0		3,20
10752	10,5	2,0		4,60



Kühlakku

cooler
 acumulador de frío
 accumulateur de froid



gefüllt mit Kühlflüssigkeit, nicht giftig, einfach im Gefrierfach einfrieren, unbegrenzt wiederverwendbar
 freeze it in freezer, non toxic, filled with freezer-liquid, boundless reusable
 se enfría en el congelador, no tóxico, se puede reutilizar sin límite
 liquide eutectique qui accumule froid une fois dans le congélateur, non toxique, réutilisable sans limites

	cm	↑ cm	Farbe / Colour	€
10782	41 x 21	2,5		14,20
10791	25 x 19	2,5		7,20
11101	16 x 7,5	2,0		4,70



Aufsteller „ACHTUNG RUTSCHGEFAHR“

stand
 letrero
 panneau



	cm	↑ cm	Farbe / Colour	€
71421	30 x 63	63		6,60

Icon-Index / Material-Index

 neuer Artikel new item	 spülmaschinengeeignet dishwasher-proof	 für Induktionsplatten for induction use
 niedriger Preis hot price	 nicht spülmaschinengeeignet not dishwasher-proof	 kühlbar for cooling
 Made in Germany	 abwaschbar / wasserfest water-proof	 doppelwandig double wall
 GN-Größen GN norm	 mikrowellengeeignet microwave-proof	 bruchsicher shatter-proof
 stapelbar stackable	 nicht mikrowellengeeignet not microwave-proof	 Eigenmontage self assembly
 Antirutsch-Füßchen non-slip feet	 keine direkte Hitze not direct heat	 für Lebensmittelkontakt food safe
 Inhaltsangabe volume	 nicht für Backofen not for baking oven	 nicht für Lebensmittelkontakt non food safe

APS - BSCI-Mitglied

APS engagiert sich für die Verbesserung von Arbeitsbedingungen. Wir sind Partner der europäischen Organisation BSCI. Die "Business Social Compliance Initiative" (BSCI) ist eine Initiative von Unternehmen zur Verbesserung der Arbeitsbedingungen in der globalen Versorgungskette.

APS is a member of BSCI

APS is committed to the improvement of working conditions. We are a partner of the European organization BSCI. The "Business Social Compliance Initiative" is an initiative of enterprises to improve working conditions in the global supply chain.



APS Melamin - Garantierte Qualität

APS-Melaminprodukte entsprechen den Richtlinien (EG) 1935/2004 und (EU) 10/2011 der Europäischen Kommission. Diese enthalten Bestimmungen für Materialien aus Kunststoffen, welche mit Lebensmitteln in Berührung kommen. Wir arbeiten sehr eng mit den Zertifizierungsinstitutionen Intertek und TÜV zusammen und können somit die Lebensmittelsicherheit (LFGB Regulation) der APS-Melaminartikel garantieren.

APS Melamine - Guaranteed quality

APS melamine products comply with directives (EG) 1935/2004 and (EU) 10/2011 of the European Commission. This contain provisions for plastic materials which come into contact with foodstuffs. We work very closely together with the certification institutions Intertek and TÜV and are therefore able to guarantee the compatibility with foodstuffs (German LFGB regulation) of APS melamine.

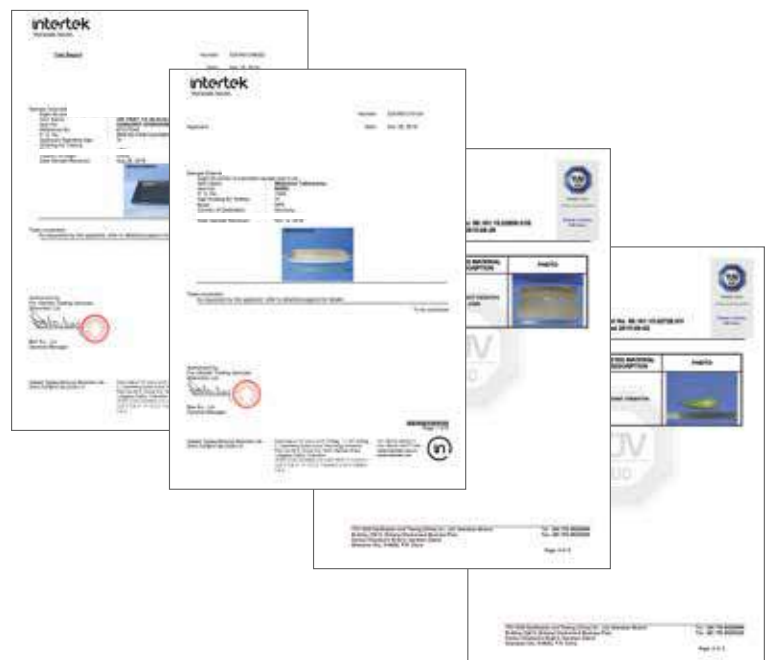

**Edelstahl 18/10 / Stainless steel 18/10**

Werkstoff 1.4301; rostfrei; langlebig; gute isolierende Eigenschaften; absolut hygienisch und nicht toxisch; recyclebar; nicht resistent gegen dauerhaften Kontakt mit Chloriden und Säuren (z. B. Kochsalz und Fruchtsäuren); sterilisierbar; Oberfläche lässt sich vielfältig polieren; nicht magnetisch; Gebrauchstemperatur bis ca. 400 °C

Pflege: pflegeleicht; maschinell oder per Hand mit milden Spülmitteln; möglichst keine Stahlwolle u. ä. verwenden; nach Erhitzung Schockabkühlung vermeiden

**Edelstahl (unspezif.) / Stainless steel (unspecific)**

niedrig nickelhaltige Edelstähle wie 14/4; nicht magnetisch; geringere allgemeine Resistenz als Edelstahl 18/10; Pflege: s. Edelstahl 18/10

**Edelstahl 18/0 / Stainless steel 18/0**

Werkstoff 1.4016; rostfrei; langlebig bei entsprechender Pflege; absolut hygienisch und nicht toxisch; gut härtbar, daher idealer Stahl für Tafelmesser, Tablets, Schneidwerkzeuge u. ä.; lässt sich hochglanzpolieren; für Nickelallergiker geeignet; magnetisch; nicht so chemikalienresistent wie Edelstahl 18/10; Gebrauchstemperatur bis ca. 400 °C

Pflege: maschinell oder per Hand mit milden Spülmitteln; Ablagerungen von Kalk und Reinigerresten nach dem Spülen unbedingt entfernen; niemals mit Stahlwolle reinigen

**Eisen / Iron**

nicht rostfrei; charakteristische, strukturierte Oberfläche mit unterschiedlichen Schattierungen; durch wiederholten Schmiedevorgang ist das Material stark verdichtet und sehr hart; langlebig bei entsprechender Pflege, Pflege: vor erstem Einsatz mit Öl und Kartoffelschalen „einbraten“; später nach jeder Reinigung einfetten; stets trocken lagern

**Gusseisen / Cast Iron**

langlebig bei entsprechender Pflege; geeignet für alle Herdarten (inkl. Induktion); speichert lange Wärme und gibt sie gleichmäßig ab; absolut hygienisch bei unbeschädigter Oberfläche; relativ schweres Material; Überhitzung fast nicht möglich; nicht schlagfest; magnetisch, Pflege: nach Gebrauch sofort mit heißem Wasser reinigen; bei Fleckenbildung mit Essig nachreinigen; niemals mit Stahlwolle reinigen; milde Spülmittel verwenden; stets trocken lagern

**Versilberter Stahl / Silver plated steel**

Edelmetallüberzug; nicht völlig säurefest; nicht über längere Zeit Sonnenlicht aussetzen

Pflege: niemals scheuernde Hilfsmittel verwenden; nur mit weichem Lappen und Spezialmitteln reinigen; keine Spülmaschinenreinigung!

**Verchromter Stahl / Chrome plated steel**

nichtedles Metall mit hartem Chromüberzug; nicht säurefest; nach Beschädigung der Chromschicht kein Schutz gegen Umwelteinflüsse

Pflege: niemals scheuernde Hilfsmittel verwenden; nur mit weichem Lappen

**Aluminium**

sehr leichtes Material; sehr gute elektrische und thermische Leitfähigkeit; korrosionsbeständig; nicht spülmaschineneeignet; Gebrauchstemperatur bis ca. +500 °C

**Porzellan**

spülmaschineneeignet; hitzebeständig bis ca. +220 °C

**GFK – Glasfaserverstärkter Kunststoff**

starr; nahezu unzerbrechlich; spülmaschineneeignet; Gebrauchstemperatur bis ca. +100 °C

**ABS – Acrylnitril-Butadien-Styrol**

sehr gute Oberflächenhärte; temperaturwechselfest; spülmaschineneeignet; Gebrauchstemperatur bis ca. +100 °C

**ACRYL – künstliches Harz**

farblos; glasartig; durchsichtig; nicht splitternd; chemisch modifiziert als Plexiglas®; wichtiger Pflegehinweis: nur handelsübliche Acrylspezialreiniger oder milde alkohol- und ammoniakfreie Reinigungsmittel verwenden; nicht spülmaschineneeignet; Gebrauchstemperatur ca. -40 °C bis ca. +50 °C

**EVA - Ethylenvinylacetat**

weich elastisch; glänzend; abwaschbar / wasserfest

Gebrauchstemperatur bis ca. +60 °C

**MF - Melamin**

sehr hart; stoß- und kratzfest; hygienisch; säurebeständig; spülmaschineneeignet; Gebrauchstemp. ca. -30 °C bis +70 °C

**MS - Kunststoff**

farblos; glasartig; durchsichtig; nicht spülmaschineneeignet; Gebrauchstemperatur ca. 0 °C bis ca. +70 °C

**PA - Polyamid**

starr; bruch- und schlagfest; mattglänzend; spülmaschineneeignet; Gebrauchstemperatur bis ca. +220 °C

**PC - Polycarbonat**

starr; nahezu unzerbrechlich; sehr stabil; formbeständig in kochendem Wasser; spülmaschineneeignet; mikrowelleneeignet; Gebrauchstemperatur ca. -30 °C bis ca. +100 °C

**PE - Polyethylen****HDPE – hochdichtes Polyethylen**

hart elastisch; unzerbrechlich; ausreichend formbeständig in heißem Wasser; glänzend; spülmaschineneeignet; Gebrauchstemperatur ca. -40 °C bis ca. +120 °C

NDPE – niederdichtes Polyethylen

weich elastisch; unzerbrechlich; kurzzeitig formbeständig in heißem Wasser; nicht glänzend; spülmaschineneeignet; Gebrauchstemperatur ca. -40 °C bis ca. +95 °C

**PP - Polypropylen**

hart elastisch; unzerbrechlich; umweltschonend recyclebar; spülmaschineneeignet; mikrowelleneeignet; Gebrauchstemperatur ca. -30 °C bis ca. +75 °C

**PS - Polystyrol**

starr; kratzfest; formbeständig in kochendem Wasser; nicht spülmaschineneeignet; Gebrauchstemperatur bis ca. +70 °C

**PVC - Polyvinylchlorid**

säurebeständig; schwer entflammbar; nicht spülmaschineneeignet; Gebrauchstemperatur ca. -50 °C bis ca. +60 °C

**SAN - Styrol-Acrylnitril**

gute Oberflächenhärte; temperaturwechselfest; spülmaschineneeignet; Gebrauchstemperatur bis ca. +100 °C

**Silikon**

hohe thermische Beständigkeit; gute Kälteflexibilität; spülmaschineneeignet; Gebrauchstemp. ca. -70 °C bis ca. +180 °C

**Tritan®**

starr; unzerbrechlich; absolut formbeständig; sehr hohe Chemikalienbeständigkeit; spülmaschinenfest; Gebrauchstemperatur ca. -30 °C bis ca. +95 °C; nicht mikrowelleneeignet

**Schiefer®**

Naturschiefer versiegelt; lebensmittelecht; nicht spülmaschineneeignet;

**Beton®**

Werkstoff Beton, coole Optik; nicht spülmaschineneeignet; handgefertigt

Laserlogo Individual

perfekte Lasergravuren
perfectly Laser engravings
grabado perfecto por láser
marcage laser parfait



Unverwechselbar - Einzigartig -Imagefördernd Ihre individuelle Lasergravur von APS

Wir bieten Ihnen die Möglichkeit, unsere Produkte mit Ihrem individuellen Logo per Laser zu gravieren - einzigartig, unverwechselbar und bereits ab 10 Stück je Artikel. Die perfekte Beschriftung durch modernste Lasertechnologie ist spülmaschinenfest und somit dauerhaft auf allen Edelstahl- und Naturschieferprodukten, sowie auf versilberten und verchromten Metall-Artikeln umsetzbar. Machen Sie aus Ihren Gastnorm-Behältern Ihre ganz persönlichen Unikate und werten Sie Ihre Servierartikel mit Ihrem eigenen Logo auf.

- geringe Mindestbestellmenge von nur 10 Stück
- kurze Lieferzeiten
- Logos bis zu einer Fläche von max. 10 x 10 cm realisierbar

Distinct - Unique - Image enhancing Your individualised laser engraving by APS

We offer you the option of having your personalised logo engraved on our products - inimitable, unique, and available for delivery from only 10 pieces per product. The perfect inscription by use of the newest technology is dishwasher-safe and thus can be permanently applied to products made of stainless steel and natural slate, as well as silver-coated and chromed metal articles. Turn your gastrom container into your individual, one of a kind article and enhance your serving items with your own logo.

- minimum order quantity of only 10 pieces
- swift delivery
- feasible logos are those with a maximum size of 10 x 10 cm

Único, personalizado, promotor de imagen Grabado laser por APS

Podemos grabar su logo y así personalizar los productos APS a partir de mínimo 10 unidades por referencia.

Gracias a la novedosa tecnología de grabado por láser, la inscripción es perfecta y resistente al lavavajillas. Se puede aplicar a los artículos en acero inoxidable, pizarra natural, metal cromado y plateado.

- Cantidad mínima de solamente 10 unidades
- Realización rápida
- Tamaño de logos hasta máximo 10 x 10 cm

Unique, original, porteur d'image Marcage laser par APS

Nous pouvons graver votre logo et ainsi personnaliser les produits APS à partir de 10 pièces par référence.

Grâce à une technologie d'avant-garde de marcage par laser, l'inscription est parfaitement reproduite et résistante au lave-vaisselle. Ce type de marcage peut s'appliquer sur l'acier inoxydable, sur l'ardoise naturelle, sur le métal chromé ou argenté.

- Quantité minimum de seulement 10 unités
- Fabrication rapide
- Taille du logo jusque 10 x 10 cm

10768	7	81	11040	3	33	11596	5	120	11846	1	75, 76	12244	4	368	14995	3	29
10769	4	81	11041	0	35, 180, 506, 508	11597	2	120	11847	8	76	12245	1	361	15100	0	149
10770	0	81				11598	9	120	11848	5	75, 76	12249	9	359, 360, 361	15101	7	149
10771	7	82	11042	7	35, 180, 326, 344, 506, 508	11599	6	120	11849	2	76	12260	4	361	15102	4	149
10772	4	82				11600	9	311	11859	1	123, 512	12285	7	370	15103	1	149
10773	1	82	11043	4	35, 180, 506	11601	6	311	11865	2	19, 121, 512	12287	1	92, 369, 371	15104	8	149
10774	8	82	11044	1	35, 180, 506	11602	3	311	11866	9	123, 512	12290	1	360, 371	15105	5	149
10775	5	81	11048	9	32	11603	0	311	11868	3	75, 76, 121, 512	12291	8	357, 358, 370	15106	2	149
10776	2	82	11065	6	33	11604	7	311				12292	5	360, 371	15108	6	149
10777	9	27, 75, 76, 77, 85, 94, 513	11100	4	32, 73	11605	4	311	11875	1	19, 77, 120, 512	12294	9	360, 371	15110	9	149
			11101	1	66, 67, 72, 74, 513	11606	1	109	11878	2	75, 76, 77, 120, 512	12295	6	353, 354, 356, 357, 358, 370	15111	6	149
10778	6	129				11607	8	109				12296	3	356, 370	15112	3	149
10781	6	513	11110	3	32	11608	5	308	11879	9	286, 512	12299	4	371	15113	0	149
10782	3	18, 513	11111	0	37	11609	2	308	11881	2	499	12300	7	359	15114	7	149
10788	5	95	11115	8	37	11610	8	308	11882	3	136	12310	6	368	15116	1	148
10789	2	95	11118	9	17	11612	2	309	11884	3	136	12320	5	360	15117	8	148
10791	5	68, 69, 70, 71, 73, 74, 513	11119	6	17	11613	9	309	11885	0	136	12321	2	360	15125	3	153
			11150	9	33	11614	6	309	11886	7	136	12322	9	352	15126	0	153
10792	2	78	11155	4	33	11615	3	309	11887	4	123	12323	6	352	15127	7	153
10793	9	99	11160	8	34	11616	0	25	11888	1	123	12324	3	353	15128	4	153
10794	6	99	11165	3	34	11617	7	25	11889	8	123	12325	0	353	15135	2	151
10795	3	99	11195	0	35	11618	4	362	11891	1	123	12350	2	359	15136	9	151
10796	0	99	11210	0	30, 34	11620	7	24	11892	8	122	12352	6	355	15137	6	151
10797	7	99	11212	4	30, 34	11621	4	24	11893	5	122	12353	3	355	15142	0	151
10798	4	99	11220	9	30, 34	11622	1	24	11894	2	499	12354	0	355	15165	9	151
10799	1	99	11222	3	30, 34	11623	8	24	11901	7	367	12355	7	364	15166	6	151
10800	4	93	11244	5	368	11624	5	107	11902	4	367	12356	4	364	15167	3	151
10801	1	94	11290	2	33	11625	2	312	11903	1	366	12357	1	364	15200	7	150
10803	5	94	11295	7	34	11626	9	24	11906	2	366	12360	1	364	15201	4	150
10804	2	94	11300	8	33	11627	6	24	11907	9	366	12366	3	355, 358	15204	5	150
10805	9	31, 96	11302	2	35	11628	3	24	11910	9	367	12370	0	355	15205	2	150
10806	6	31, 96	11305	3	35, 506	11629	0	24	11911	6	367	12371	7	355	15215	1	149
10807	3	94	11310	7	33	11630	6	310	11912	3	367	12372	4	355	15216	8	149
10808	0	94	11422	7	130	11631	3	310	11913	0	367	12384	4	358	15217	5	149
10809	7	94	11424	1	130	11632	0	310	11915	4	366	12386	1	356	15218	2	149
10810	3	94, 99	11426	5	130	11633	7	310	11916	1	366	12390	8	358	15219	9	149
10812	7	94	11427	2	130	11634	4	107, 309	11917	8	366	12391	5	358	15220	5	149
10814	1	94	11431	9	130	11635	1	311	11920	8	370	12393	9	358	15225	0	153
10820	2	93	11432	6	130	11636	8	311	11921	5	143, 279, 394	12394	6	356	15226	7	153
10825	7	98	11433	3	130	11637	5	311	11922	2	143, 279, 394	12396	0	357	15227	4	153
10830	1	97	11434	0	130	11638	2	311	11930	7	141	12397	7	355, 357	15228	1	153
10833	2	97	11435	7	130	11639	9	311	11931	4	141	12398	4	357	15230	4	150
10835	6	98	11436	4	130	11640	5	311	11940	6	395	12399	1	357	15231	1	150
10840	0	98	11437	1	130	11647	4	313	11941	3	394	12403	5	358	15232	8	149
10850	9	98	11438	8	130	11648	1	313	11942	0	394	12404	2	356	15233	5	149
10851	6	88, 89, 91	11439	5	130	11649	8	312	11943	7	394	12415	8	104	15234	2	149
10853	0	91	11442	5	131	11650	4	312	11945	1	389	12483	7	359	15235	9	149
10855	4	91, 95	11444	9	131	11651	1	312	11946	8	389	12484	4	359	15250	2	153
10859	2	98	11446	3	131	11653	5	106	11947	5	389	12879	8	286, 512	15251	9	153
10860	8	31, 96	11449	4	131	11654	2	106	11950	5	395	12940	5	16	15252	6	153
10862	2	31, 96	11451	7	132	11658	0	362	11955	0	138	12941	2	16	15253	3	153
10864	6	31, 96	11455	5	132	11660	3	106	11960	4	138, 390	12990	0	426	15300	4	154
10865	3	31, 96	11456	2	132	11661	0	106	11965	9	138, 390	13122	4	40	15301	1	154
10867	7	31, 96	11466	1	142	11662	2	92, 369	11966	6	138, 333, 390	13377	8	493	15302	8	154
10870	7	28, 97	11467	8	142	11671	9	92, 369	11969	7	123	13378	5	493	15303	5	154
10871	4	28, 97	11495	1	118, 121	11672	6	92, 369	11970	3	128	13379	2	493	15310	3	154
10872	1	29, 97	11496	8	121	11675	7	361	11971	0	129	13380	8	61	15311	0	154, 155
10873	8	29, 97	11497	5	121	11678	8	362	11972	7	129	13382	2	40	15312	7	154
10887	5	19, 27, 512	11498	2	121	11680	1	362	11973	4	129	13385	3	40	15313	4	154, 155
10889	9	512	11499	9	121	11683	2	373	11974	1	129	13622	9	40	15320	2	348
10890	5	19, 27, 512	11503	3	73	11692	4	362	11975	8	128	13910	7	19	15321	9	348
10907	0	98	11505	7	73	11693	1	363	11977	2	388	13915	2	19	15322	6	348
10910	0	101	11510	1	71	11699	3	362	11978	9	380	13920	6	18	15323	3	348
10911	7	101	11512	5	72	11700	6	25	11979	6	388	13925	1	18	15324	0	348
10912	4	101	11514	9	71	11701	3	25	11980	2	132	13940	4	16	15325	7	348
10913	1	100	11516	3	72	11702	0	25	11981	9	132	13941	1	16	15326	4	349
10914	8	100	11522	4	119	11703	7	25	11986	4	132	13955	8	17	15331	8	348
10915	5	100	11523	1	118, 119	11720	4	144	11987	1	133	13960	2	17	15332	5	348
10916	2	100	11524	8	118	11730	3	145	11990	1	133	13965	7	127	15334	9	348
10917	9	100	11526	2	118	11762	4	145	11991	8	133	13966	4	107	15335	6	348
10921	6	101	11527	9	118	11763	1	145	11994	9	139, 392	13980	0	27	15340	0	150, 160
10922	3	101	11528	6	119	11765	5	145	11997	0	139, 392	13981	7	27	15341	7	150, 160
10923	0	101	11529	3	119	11766	2	145	11998	7	139, 280, 392	13985	5	28	15342	4	150, 160
10924	7	101	11533	0	74	11775	4	137	11999	4	139, 280, 392	13987	9	28, 128	15343	1	150, 160
10990	2	83, 442	11538	5	74	11776	1	137	12000	6	32	13990	9	26	15344	8	150, 160
11000	7	32	11540	8	69	11778	5	144	12008	2	507	13995	4	28	15345	5	150
11008	3	69, 73, 337, 507	11541	5	69	11780	8	144	12010	5	507	14910	6	19	15346	2	150
			11542	2	70	11781	5	144	12040	2	33	14915	1	19	15347	9	150
11010	6	69, 71, 73, 337, 507	11543	9	70	11794	5	30	12050	1	126	14920	5	18	15348	6	150
			11553	8	338	11795	2	30	12051	8	126	14925	0	18	15350	9	155, 509
11013	7	507	11555	2	338	11805	8	127	12054	9	126	14940</					

15412	4	160	15522	0	104, 157, 165	30281	5	341	35735	8	274	40200	3	272	40470	0	301
15413	1	160	15523	7	157	30282	2	341	35912	3	59, 275, 451	40201	0	272	40472	4	301
15414	8	160	15524	4	157	30283	9	341	36003	7	398	40202	7	272	40474	8	301
15415	5	160	15525	1	157	30284	6	341	36004	4	398	40203	4	272	40476	2	301
15416	2	160	15526	8	157	30285	3	341	36007	5	415	40204	1	272	40478	6	301
15417	9	160	15530	5	157	30286	0	341	36010	5	414	40205	8	272	40480	9	301
15418	6	160	15531	2	157	30287	7	341	36011	2	414	40206	5	272	40482	3	302
15419	3	160	15532	9	157	30288	4	341	36013	6	424	40207	2	272	40485	4	303
15420	9	160	15533	6	157	30299	0	343	36015	0	424	40208	9	272	40486	1	305, 441
15421	6	160	15534	3	157	30310	2	346	36017	4	426	40210	2	340	40487	8	306, 441
15422	3	160	15535	0	157	30320	1	346	36020	4	398	40211	9	340	40488	5	305, 441
15423	0	160	15921	1	271, 307	30325	6	110, 346	36021	1	398	40212	6	340	40490	8	304, 440
15424	7	161	15925	9	271, 307	30332	4	400	36022	8	424	40214	0	340	40494	6	304, 440
15425	4	161	15926	6	271, 307	30333	1	407	36024	2	424	40216	4	340	40498	4	304, 440
15426	1	161	17910	3	17	30340	9	343	36025	9	399	40220	1	334	40499	1	304, 440
15427	8	161	17922	6	18	30341	6	343	36026	6	399	40222	5	334	40500	4	296
15428	5	161	18380	3	52, 509	30350	8	343	36027	3	424	40223	2	333	40501	1	296
15429	2	161	18387	2	70, 336, 509	30351	5	343	36028	0	399	40224	9	334	40503	5	296
15430	8	161	18388	9	70, 72, 74, 155,	30360	7	343	36029	7	424	40225	6	333	40504	2	296
15431	5	161			245, 336, 509	30361	4	343	36030	3	404	40226	3	334	40505	9	296
15432	2	161	18389	6	20, 336	30370	6	343	36032	7	406	40227	0	333	40506	6	305, 441
15433	9	161	18394	0	39	30371	3	343	36033	4	425	40228	7	334	40507	3	296
15434	6	161	2			30380	5	343	36034	1	406	40229	4	333	40508	0	306, 442
15435	3	161	23642	4	41, 268	30385	0	343	36036	5	404	40230	0	334	40520	2	292
15436	0	161	24330	9	110	30390	4	343	36037	2	425	40240	9	334	40521	9	292
15437	7	161	24331	6	110	30410	9	344	36038	9	404	40242	3	334	40522	6	292
15438	4	161	24332	3	110	30411	6	344	36044	0	403	40243	0	333	40524	0	292
15439	1	159	24334	7	110	30412	3	344	36045	7	402	40244	7	334	40530	1	292
15440	7	159	24335	4	110	30413	0	344	36046	4	402	40245	4	333	40531	8	292
15441	4	159	24336	1	110	30414	7	344	36047	1	402	40246	1	334	40532	5	292
15442	1	159	24338	5	110	30415	4	344	36048	8	403	40247	8	333	40534	9	292
15443	8	159	24339	2	110	30416	1	344	36050	1	405	40248	5	334	40535	6	291
15444	5	159	3			30440	6	342	36052	5	403	40249	2	333	40536	3	292
15445	2	159	30000	2	15	30441	3	342	36053	2	403	40250	8	334	40537	0	291
15446	9	159	30001	9	15	30442	0	342	36054	9	403	40260	7	334	40538	7	290
15447	6	159	30002	6	15	30443	7	342	36055	6	400	40262	1	334	40539	4	290
15448	3	159	30020	0	23	30444	4	342	36056	3	403	40263	8	334	40540	0	291
15449	0	158	30021	7	23	30445	1	342	36057	0	403	40264	5	334	40541	7	291
15450	6	158	30041	5	63, 271	30446	8	342	36062	4	405	40266	9	334	40544	8	293
15451	3	158	30043	9	65	30447	5	342	36063	1	405	40268	3	334	40545	5	293
15452	0	158	30045	3	491	30450	5	342	36066	2	399	40270	6	334	40546	2	291
15453	7	158	30046	0	491	30451	2	342	36068	6	400	40272	0	334	40547	9	292
15454	4	158	30047	7	491	33210	2	105	36069	3	400	40274	4	334	40548	6	291
15455	1	158	30048	4	491	33211	9	112	36074	7	404	40276	8	334	40549	3	288
15456	8	158	30049	1	491	33212	6	112	36075	4	406	40278	2	334	40550	9	288
15457	5	158	30050	7	27	33214	0	111	36077	8	402	40280	5	334	40551	6	288
15458	2	158	30052	1	27	33215	7	112	36081	5	399	40290	4	20, 333	40552	3	288
15459	9	158	30054	5	491	33216	4	111	36082	2	401	40291	1	20, 333	40553	0	289
15460	5	158	30055	2	491	33217	1	111	36083	9	406	40292	8	20, 333	40554	7	289
15461	2	163	30057	6	491	33219	5	112	36087	7	401	40293	5	20, 333	40555	4	289
15462	9	163	30060	6	64	33220	1	112	36090	7	405	40294	2	20, 337	40556	1	289
15467	4	163	30101	6	60	33221	8	338	36091	4	401	40295	9	20, 336	40557	8	290
15468	1	163	30102	3	60	33222	5	116	36092	1	398	40296	6	329	40558	5	290
15473	5	163	30103	0	60	33225	6	111	36093	8	398	40297	3	329	40559	2	291
15474	2	163	30104	7	60	33226	3	116	36095	2	401	40299	7	343	40560	8	291
15475	9	163	30108	5	59, 451	33227	0	116	36096	9	401	40300	0	303	40600	1	256
15476	6	163	30109	2	59, 451	33228	7	116	36099	0	405	40310	9	299	40601	8	256
15477	3	163	30110	8	59, 451	33231	7	113	36233	8	274	40311	6	299	40602	5	257
15478	0	163	30111	5	45, 447	33232	4	108	36323	6	274	40312	3	299	40603	2	257
15479	7	163	30112	2	45, 447	33235	5	112	38202	2	37	40313	0	299	40605	6	258
15480	3	163	30113	9	45, 447	33238	6	113	4			40320	8	299	40606	3	258
15483	4	163	30114	6	44, 446	33240	9	112	40007	8	276, 340, 393	40330	7	302	40607	0	258
15484	1	163	30115	3	45, 447	33241	6	117	40009	2	276, 340, 393	40331	4	302	40610	0	256
15485	8	163	30116	0	45, 447	33242	3	117	40010	8	276, 340, 393	40404	5	313	40611	7	256
15486	5	163	30117	7	45, 447	33243	0	115	40011	5	276, 340, 393	40405	2	313	40612	4	257
15487	2	163	30118	4	44, 446	33246	1	264	40012	2	276, 340, 393	40410	6	298	40613	1	257
15488	9	163	30119	1	44, 446	33247	8	264	40013	9	276, 340, 393	40411	3	298	40616	2	258
15489	6	163	30120	7	44, 115, 239	33248	5	113	40110	5	37, 346	40412	0	298	40617	9	258
15490	2	163	30121	4	44, 115, 239	33249	2	102	40115	0	37, 346	40413	7	298	40618	6	258
15491	9	163	30122	1	44, 115, 239	33250	8	102	40129	7	336	40415	1	299	40620	9	256
15492	6	163	30123	8	45, 447	33251	5	102	40130	3	276, 340, 393	40424	3	302	40621	6	256
15495	7	163	30124	5	45, 447	33252	2	102	40131	0	276, 340, 393	40425	0	285	40622	3	257
15496	4	163	30126	9	45, 447	33255	3	14, 15, 103	40132	7	335	40435	9	297	40623	0	257
15501	5	165	30127	6	45, 447	33256	0	14, 15, 103	40135	8	335	40436	6	297	40630	8	258
15502	2	165	30136	8	45, 447	33260	7	102	40137	2	335	40437	3	297	40631	5	258
15503	9	165	30137	5	45, 447	33261	4	102	40139	6	335	40438	0	297	40632	2	261
15504	6	165	30200	6	345	33262	1	102	40140	2	335	40439	7	297	40633	9	261
15505	3	165	30205	1	345	33269	0	102	40144	0	335	40440	3	299	40634	6	261
15506	0	165	30206	8	345	33270	6	102	40148	8	335	40441	0	299	40635	3	261
15507	7	165	30210	5	345	33271	3	102	40149	5	336	40442	7	297	40636	0	261
15508	4	165	30220	4	345	33272	0	103	40150	1	337	40443	4				

40663	6	260	50901	6	327	71441	0	389	75906	0	470	81907	8	376	82319	8	265
40664	3	260	50902	3	327	71460	1	282	75907	7	469	81908	5	376	82328	0	127, 135, 497
40665	0	260	50903	0	327	71461	8	282	75908	4	469	81909	2	376	82338	9	265
40666	7	260	50905	4	327	71462	5	282	75909	1	470	81910	8	376	82345	7	263
40667	4	260	50906	1	327	71470	0	286	75910	7	468	81911	5	376	82346	4	263
40668	1	260	50907	8	327	71471	7	286	75911	4	468	81997	9	377	82347	1	263
40669	8	260	50908	5	327	71472	4	286	75912	1	470	81998	6	377	82355	6	17, 53, 381
40670	4	50, 259	50910	8	327	71474	8	286	77315	8	443, 483	81999	3	377	82356	3	17, 53, 381
40671	1	50, 259	50911	5	327	71480	9	286	77338	7	490	82001	2	378	82357	0	17, 53, 381
40672	8	50, 259	50912	2	327	71482	3	286	77350	9	495	82003	6	378	82359	4	263
40673	5	50, 259	50913	9	327	71483	0	286	77352	3	495	82004	3	378	82370	9	263
40674	2	50, 259	50915	3	328	71487	8	285	79553	2	52, 114	82005	0	378	82371	6	263
40752	7	511	50916	0	328	71489	2	285	8			82006	7	378	82394	5	265
5			50917	7	328	71490	8	287	80023	6	377	82007	4	378	82395	2	265
50002	0	52	50918	4	328	71491	5	287	80024	3	377	82008	1	378	82419	5	394
50100	3	330	6			71492	2	283	80025	0	377	82010	4	378	82420	1	394
50105	8	330	60002	7	321	71493	9	283	80026	7	377	82012	8	378	83301	2	53, 381
50110	2	330	60012	6	321	71494	6	283	80027	4	377	82013	5	378	83303	6	53, 381
50205	5	330	60014	0	321	71495	3	285	80028	1	377	82014	2	378	83304	3	53, 381
50210	9	330	60015	7	321	71498	4	285	80029	8	377	82016	6	378	83305	0	53, 381
50215	4	330	60016	4	321	71499	1	285	81000	6	375	82017	3	378	83309	8	65
50300	7	330	60018	8	321	71510	3	281	81095	2	375	82018	0	378	83310	4	65
50305	2	330	60019	5	321	71511	0	281	81100	3	375	82019	7	378	83311	1	65
50310	6	330	60020	1	323	71512	7	281	81101	0	375	82020	3	378	83400	2	235
50315	1	330	60022	5	323	71513	4	281	81102	7	375	82022	7	378	83401	9	234
50400	4	330	60023	2	323	71514	1	281	81104	1	375	82023	4	378	83402	6	235
50500	1	329	60024	9	323	71515	8	281	81106	5	375	82028	9	378	83403	3	115, 235
50501	8	329	60037	9	319	71516	5	281	81108	9	375	82029	6	378	83404	0	235
50510	0	329	60038	6	319	71517	2	281	81109	6	375	82030	2	378	83405	7	235
50600	8	331	60039	3	319	71518	9	281	81116	4	373	82032	6	378	83406	4	235
50601	5	331	60040	9	319	71700	8	495	81117	1	377	82034	0	378	83407	1	235
50602	2	331	60041	6	321	71701	5	495	81118	8	377	82036	4	378	83408	8	236
50603	9	331	60042	3	321	73502	6	503	81191	1	376	82037	1	378	83409	5	236
50605	3	331	60044	7	320	73503	3	503	81195	9	376	82038	8	378	83410	1	236
50606	0	331	60045	4	320	73504	0	503	81198	0	380	82040	1	378	83411	8	239
50607	7	331	60046	1	320	73505	7	503	81199	7	380	82042	5	378	83412	5	239
50608	4	331	60270	0	60	73506	4	503	81200	0	375	82050	0	378	83414	9	115, 236, 239
50610	7	331	60310	3	60	73507	1	503	81201	7	375	82051	7	378	83415	6	236
50611	4	331	60502	2	319	73508	8	503	81202	4	375	82059	3	378	83417	0	235
50612	1	331	60503	9	319	73509	5	503	81204	8	375	82100	2	381	83418	7	235
50613	8	331	60505	3	319	73510	1	503	81206	2	375	82101	9	379	83419	4	236
50620	6	332	60506	0	322	73511	8	503	81208	6	375	82104	0	379	83424	8	247
50621	3	332	60507	7	322	73513	2	503	81209	3	375	82106	4	379	83426	2	247
50622	0	332	60508	4	322	73700	6	502	81292	5	376	82108	8	379	83433	0	234
50623	7	332	60509	1	321	73701	3	502	81295	6	376	82104	0	379	83434	7	234
50624	4	332	60510	7	322	73702	0	502	81296	3	380	82112	5	379	83435	4	241
50625	1	332	60511	4	322	73703	7	502	81300	7	375	82113	2	379	83437	8	241
50626	8	332	60512	1	321	73711	2	502	81302	1	375	82114	9	379	83438	5	241
50627	5	332	60520	6	321	73712	9	502	81304	5	375	82116	3	379	83440	8	241
50628	2	332	60521	3	321	73713	6	502	81306	9	375	82117	0	379	83441	5	241
50629	9	332	60522	0	321	73714	3	502	81308	3	375	82118	7	379	83443	9	241
50630	5	332	60523	7	321	73725	9	502	81391	5	376	82119	4	379	83446	0	241
50631	2	332	60524	4	321	73726	6	502	81395	3	376	82120	0	379	83447	7	241
50632	9	332	60525	1	320	73727	3	502	81400	4	375	82122	4	379	83449	1	241
50633	6	332	60526	8	320	73739	6	503	81401	1	375	82123	1	379	83450	7	236
50634	3	332	60527	5	320	73740	2	503	81402	8	375	82128	6	379	83451	4	236
50635	0	332	60528	2	320	73741	9	503	81404	2	375	82129	3	379	83452	1	236
50640	4	326	60530	5	322	73742	6	503	81406	6	375	82130	9	379	83453	8	236
50641	1	326	60531	2	322	73743	3	503	81408	0	375	82132	3	379	83454	5	236
50642	8	326	60532	9	322	73750	1	502	81492	9	376	82134	7	379	83455	2	236
50643	5	326	60533	6	322	74201	7	475	81495	0	376	82136	1	379	83456	9	236
50644	2	326	60534	3	322	74207	9	60	81502	5	375	82137	8	379	83457	6	236
50645	9	326	60535	0	320	74402	8	489	81504	9	375	82138	5	379	83466	8	236
50700	5	328	60536	7	320	74404	2	489	81506	3	375	82140	8	379	83467	5	236
50701	2	328	60537	4	320	74700	5	488	81591	9	376	82142	2	379	83468	2	236
50702	9	328	60540	4	322	74701	2	488	81595	7	376	82150	7	379	83469	9	236
50703	6	328	60541	1	322	74702	9	488	81602	2	375	82151	4	379	83479	8	234
50705	0	328	60542	8	321	74703	6	488	81604	6	375	82159	0	379	83480	4	234
50706	7	328	60550	3	323	74705	0	488	81606	0	375	82200	9	381	83481	1	234
50707	4	328	60551	0	323	74706	7	488	81608	4	375	82201	6	381	83482	8	234
50708	1	328	60552	7	323	74721	0	488	81692	3	376	82202	3	381	83483	5	235
50710	4	327	60553	4	323	74722	7	488	81695	4	376	82203	0	381	83484	2	235
50711	1	327	60554	1	323	74731	9	491	81700	5	375	82204	7	381	83486	6	247
50712	8	327	61190	0	60	74732	6	491	81701	2	375	82205	4	381	83487	3	247
50713	5	327	61280	8	60	74750	0	83, 445	81702	9	375	82210	8	353	83488	0	454
50714	2	327	61400	0	60	75001	2	271	81704	3	375	82215	3	353	83489	7	454
50720	3	328	7			75002	9	271	81706	7	375	82250	4	134, 496	83490	3	234
50721	0	328	70303	2	499	75600	7	474	81707	4	375	82251	1	134, 496	83491	0	234
50722	7	328	71001	6	474	75800	1	472	81791	3	376	82252	8	134, 496	83492	7	234
50723	4	328	71002	3	474	75801	8	473	81795	1	376	82253	5	134, 496	83497	2	238
50800	2	331	71003	0	474	75802	2	474	81796	8	380	82255	9	134, 496	83498	9	238
50801	9	331	71004	7	474	75804	9	474	81800	2	375	82256	6	134, 496	83499	6	238
50802	6	331	71005</														

83566	5	235	83759	1	119, 382	83906	9	232	84108	6	213	84247	2	206	84434	6	197
83567	2	235	83760	7	383	83907	6	232	84109	3	213	84248	9	206	84435	3	197
83568	9	115, 236, 239	83761	4	383	83908	3	232, 233, 511	84110	9	214	84250	2	44, 446	84440	7	238
83569	6	115, 236, 239	83762	1	383	83909	0	232, 233, 511	84111	6	214	84251	9	44, 446	84441	4	238
83570	2	236	83763	8	383	83910	6	233	84112	3	214	84252	6	44, 446	84444	5	250
83571	9	236	83764	5	383	83911	3	233	84113	0	214	84253	3	44, 446	84445	2	250
83572	6	236	83765	2	383	83912	0	229, 233	84114	7	214	84256	4	61, 200	84446	9	250
83573	3	236	83766	9	383	83913	7	117, 233, 511	84115	4	214	84257	1	207	84448	3	250
83574	0	236	83768	3	383	83914	4	229, 233	84116	1	214	84258	8	207	84449	0	250
83575	7	236	83769	0	383	83915	1	117, 233	84117	8	214	84259	5	207	84450	6	251
83587	0	228	83770	6	383	83916	8	117, 233, 511	84118	5	214	84260	1	221	84452	0	251
83588	7	234	83772	0	383	83917	5	117, 233, 511	84119	2	214	84261	8	221	84454	4	251
83589	4	234	83773	7	383	83918	2	117, 233, 511	84120	6	222	84262	5	198	84456	8	251
83592	4	234	83777	5	243	83919	9	117, 233, 511	84125	3	222	84263	2	198	84458	2	251
83593	1	234	83779	9	226	83920	5	77, 233, 243, 270, 511	84126	0	222	84264	9	61, 198	84460	5	251
83594	8	234	83780	5	243	83921	2	233, 511	84127	7	222	84265	6	61, 198	84462	9	227
83597	9	234	83781	2	243	83922	9	233, 511	84128	4	222, 246	84266	3	200	84464	3	227
83598	6	234	83782	9	243	83923	6	233	84130	7	223	84267	0	200	84466	7	227
83599	3	234	83783	6	243	83924	3	233	84131	4	223	84268	7	61, 200	84470	4	196
83600	6	187, 205, 237, 511	83784	3	243	83925	0	233	84132	1	223	84269	4	61, 200	84471	1	196
83601	3	187, 205, 237, 511	83785	0	226	83926	7	233	84133	8	223	84295	3	244	84472	8	196
83602	0	237, 511	83786	7	226	83927	1	215	84134	5	223	84300	4	382	84473	5	196
83610	5	454	83787	4	226	83928	8	215	84135	2	223	84301	1	119, 382	84474	2	196
83611	2	454	83788	1	226	83929	8	215	84136	9	223	84302	8	382	84475	9	196
83612	9	454	83789	8	226	83932	8	218	84137	6	223	84303	5	119, 382	84476	6	196
83613	6	454	83790	4	226	83933	5	218	84140	6	246	84304	2	382	84478	0	196
83614	3	455	83791	1	227	83934	2	218	84141	3	246	84305	9	118, 382	84479	7	196
83615	0	124, 349	83792	8	227	83935	9	218	84142	0	246	84306	6	382	84481	0	196
83616	7	455	83794	2	227	83940	3	219	84143	7	246	84307	3	382	84482	7	196
83625	9	235	83795	9	227	83941	0	219	84150	5	383	84308	0	382	84484	1	196
83626	6	235	83796	6	227	83946	5	218	84153	6	383	84309	7	382	84490	2	242
83639	6	224	83797	3	227	83947	2	218	84158	1	222, 246	84310	3	382	84491	9	242
83640	2	224	83798	0	226	83948	9	218	84159	8	383	84311	0	382	84492	6	242
83642	6	224	83799	7	226	83949	6	218	84161	1	209	84327	1	181	84493	3	242
83643	3	224	83800	0	225	83955	7	205	84162	8	383	84328	8	181	84494	0	242
83648	8	224	83801	7	252, 372	83956	4	205	84165	9	209	84329	5	181	84509	1	178
83649	5	224	83803	1	252, 372	83957	1	205	84166	6	383	84330	1	181	84510	7	178
83651	8	224	83808	6	225	83958	8	205	84168	0	209	84331	8	181	84511	4	178
83652	5	224	83810	9	225	83960	1	230	84169	7	383	84334	9	181	84512	1	178
83654	9	224	83812	3	225	83961	8	231	84170	3	209	84335	6	181	84514	5	178
83655	6	224	83814	7	225	83962	5	230	84171	0	209	84336	3	181	84515	2	178
83696	9	77, 243	83816	1	225	83963	2	230	84172	7	209	84337	0	181	84517	6	178
83697	6	77, 243	83818	5	225	83964	9	230	84174	1	214	84348	6	216	84519	0	180
83698	3	77, 243	83820	8	225	83965	6	230	84177	2	155, 201, 206	84349	3	216	84520	6	180
83699	0	77, 243	83826	0	225	83966	3	231	84178	9	201	84350	9	216	84521	3	180
83700	3	18, 27, 77, 122, 243	83828	4	225, 229	83967	0	230	84179	6	201	84351	6	216	84522	0	180
83701	0	18, 27, 77, 122, 243	83830	7	225	83971	7	205	84180	2	203	84352	3	216	84523	7	178, 179
83702	7	18, 27, 77, 122, 243	83832	1	225	83980	9	205	84181	9	203	84353	0	216	84524	4	178, 179
83703	4	18, 27, 77, 122, 243	83834	5	225	83981	6	205	84182	6	203	84354	7	215	84525	1	179
83704	1	77, 243	83836	9	225	83992	2	204	84183	3	203	84355	4	215	84526	8	178, 179
83705	8	77, 243	83842	0	247	83994	6	204	84184	0	203	84360	8	202	84528	2	178, 179
83710	2	215	83843	7	247	83999	1	141, 279	84185	7	25, 55, 203	84361	5	202	84529	9	178, 179
83712	6	215	83844	4	247	84017	1	251	84186	4	25, 55, 203	84362	2	202	84530	5	179
83714	0	216	83845	1	247	84018	8	251	84187	1	55, 203	84363	9	202	84531	2	393
83716	4	216	83847	5	140, 278	84020	1	252	84188	8	25, 55, 203	84364	6	202	84532	9	393
83718	8	217	83848	2	253	84021	8	252	84189	5	25, 55, 203	84365	3	184	84535	0	142, 279, 391
83720	1	217	83851	2	253	84022	5	220	84195	6	25, 55, 203	84366	0	184	84536	7	142, 279, 391
83721	8	217	83862	8	240	84023	2	220	84196	3	5, 55, 203	84367	7	184	84540	4	186
83722	5	217	83864	2	240	84024	9	220	84197	0	55, 106, 203	84373	8	184, 185	84541	1	186
83723	2	217	83865	9	241	84025	6	220	84198	7	25, 55, 203	84374	5	185	84542	8	186
83724	9	217	83866	6	241	84026	3	220	84199	4	25, 55, 203	84375	2	185	84543	5	186
83725	6	216	83867	3	64, 65	84035	5	252	84200	7	228	84376	9	185	84544	2	186
83726	3	217	83868	0	65	84039	3	293	84202	1	228	84377	6	184, 185	84545	9	187
83727	0	216	83869	7	235, 245	84040	9	242	84205	2	199	84378	3	184, 185	84546	6	187
83728	7	217	83875	8	241	84041	6	242	84206	9	199	84379	0	184, 185	84549	7	187
83730	0	217	83876	5	241	84042	3	242	84207	6	199	84380	6	185	84550	3	187
83732	4	217	83877	2	241	84043	0	242	84208	3	199	84381	3	184, 185	84551	0	186, 187
83733	1	216	83878	9	229	84045	4	56, 448	84209	0	199	84387	5	227	84552	7	186, 187
83734	8	219	83879	6	229	84046	1	17, 239	84212	0	454	84400	1	183	84553	4	187, 511
83735	5	216	83880	2	132, 133, 243	84047	8	17, 21, 239	84213	7	454	84401	8	183	84554	1	187, 511
83736	2	219	83881	9	133, 243	84048	5	17, 239	84215	1	244	84402	5	183	84555	8	192
83737	9	216	83882	6	232	84050	8	383	84216	8	244	84403	2	183	84556	5	192
83738	6	219	83884	0	63, 155, 206, 235	84053	9	383	84217	5	223, 251	84404	9	183	84557	2	195
83739	3	219	83886	4	235	84054	6	383	84218	2	223, 251	84408	7	237, 511	84558	9	193
83740	9	219	83887	1	247	84059	1	383	84220	5	244	84409	4	237	84559	6	193
83742	3	219	83888	8	247	84061	4	383	84221	2	244	84410	0	237, 511	84560	2	194
83744	7	219	83888	8	247	84062	1	383	84222	9	244	84414	8	237, 239	84561	9	193, 194, 511
83748	5	382	83889	5	247	84065	2	383	84225	0	80	84415	5	237, 239	84562	6	193, 194, 511
83749	2	118, 382	83890	1	63, 155, 206, 245	84066	9										

84579	4	189	84721	7	197	84841	2	248	88826	5	479	93163	3	500	93353	8	416
84580	0	189	84722	4	197	84842	9	248	88827	2	479	93164	0	417	93354	5	416
84581	7	188, 189	84723	1	197	84843	6	248	88828	9	479	93165	7	417	93355	2	417
84582	4	189	84724	8	197	84844	3	248	88829	6	480	93166	4	430	93356	9	418
84583	1	192	84725	5	174	84845	0	248	88834	0	480	93167	1	430	93357	6	418
84584	8	192	84726	2	174	84850	4	208	88835	7	481	93168	8	430	93358	3	423
84585	5	195	84727	9	174	84851	1	208	88836	4	481	93169	5	430	93360	6	423
84586	2	192	84728	6	213	84852	8	208	88837	1	481	93170	1	438	93361	3	423
84587	9	192	84729	3	213	84853	5	208	88839	5	481	93171	8	431	93364	4	413
84588	6	195	84730	9	213	84854	2	208	88840	1	481	93172	5	432	93365	1	413
84589	3	192	84731	6	213	84855	9	208	88841	8	482	93173	2	430	93366	8	414
84590	9	192	84732	3	213	84860	3	64	88843	2	482	93174	9	431	93367	5	409
84591	6	195	84733	0	213	84861	0	64	88844	9	482	93175	6	427	93368	2	419
84592	3	193, 194	84740	8	175	84862	7	64	88845	6	482	93179	4	414	93369	9	419
84593	0	193, 194	84741	5	175	84863	4	64, 65	88846	3	421, 480	93180	0	423	93370	5	411
84594	7	193, 194	84742	2	175	84870	2	143, 279	88849	4	480	93181	7	423	93380	4	428
84595	4	193	84743	9	175	84875	7	209	88850	0	480	93182	4	423	93381	1	428
84596	1	193	84744	6	175	84876	4	209	88853	1	483	93183	1	423	93382	8	428
84597	8	194	84745	3	175	84880	1	177	88854	8	483	93189	3	422, 495	93383	5	428
84598	5	193	84746	0	175	84881	8	177	88855	5	498	93190	9	426	93384	2	428
84599	2	193	84747	7	175	84882	5	177	88900	2	498	93191	6	427	93385	9	428
84600	5	194	84748	4	175	84883	2	177	88901	9	498	93192	3	427	93390	3	428
84601	2	190	84749	1	175	84884	9	177	88902	6	498	93193	0	427	93400	9	407
84602	9	172, 19	84750	7	249	84885	6	177	88903	3	499	93194	7	427	94144	1	434
84603	6	190	84751	4	249	84886	3	177	88910	1	498	93200	5	425	94145	8	434
84604	3	190	84752	1	249	84900	6	210	88911	8	498	93201	2	415	94146	5	434
84605	0	190, 191	84753	8	249	84901	3	210	88912	5	498	93206	7	437	94147	2	434
84606	7	190, 191	84754	5	249	84902	0	210	88920	0	484	93211	1	414	94148	9	434
84607	4	190, 191	84755	2	249	84903	7	210	88921	7	484	93212	8	414	94149	6	434
84608	1	191	84756	9	249	84904	4	210	88922	4	484	93214	2	422, 495			
84609	8	191	84757	6	249	84905	1	210, 211	88923	1	484	93220	3	425			
84610	4	191	84758	3	249	84906	8	210, 211	88928	6	484	93222	7	501			
84611	1	191	84759	0	249	84907	5	210, 211	88929	3	486	93223	4	501			
84612	8	191	84760	6	249	84908	2	211	88930	9	487	93224	1	501			
84613	5	191	84761	3	249	84909	9	210, 211	88932	3	484	93225	8	500			
84614	2	190, 191	84762	0	249	84910	5	210, 211	88933	0	484	93226	5	500			
84615	9	191	84763	7	249	84911	2	210, 211	88935	4	485	93240	1	500			
84616	6	191	84764	4	249	84912	9	210, 211	88937	8	485	93241	8	500			
84620	3	57, 253, 438	84770	5	202	84913	6	211	88938	5	485	93242	5	500			
84621	0	57, 253, 438	84771	2	202	84914	3	211	88939	2	485	93243	2	500			
84622	7	228	84772	9	202	84915	0	210, 211	88940	8	485	93244	9	500			
84623	4	228	84773	6	202	85040	8	242	88941	5	485	93245	6	500			
84624	1	241	84774	3	202	85041	5	242	88942	2	485	93299	9	433			
84625	8	248	84775	0	250	85042	2	242	88944	6	486	93300	2	420			
84626	5	248	84776	7	250	85043	9	242	88946	0	486	93301	9	433			
84627	2	248	84777	4	250	88008	5	477	88947	7	486	93302	6	433			
84630	2	208	84778	1	250	88019	1	489	88948	4	486	93303	3	430			
84631	9	208	84779	8	250	88060	3	493	88949	1	487	93304	0	430			
84632	6	208	84780	4	250	88080	1	494	9		93305	7	421				
84633	3	208	84781	1	250	88081	8	494	90901	4	66	93306	4	421			
84640	1	172	84782	8	250	88090	0	373, 494	90902	1	66, 67	93307	1	421			
84641	8	172	84783	5	250	88099	3	475	93034	6	419	93308	8	304, 435			
84642	5	172	84785	9	226	88144	0	380	93101	5	428	93309	5	304, 435			
84643	2	172	84786	6	226	88244	7	380	93102	2	435	93310	1	410			
84644	9	172	84787	3	226	88245	4	380	93105	3	82, 428	93311	8	410			
84645	6	172	84788	0	226	88246	1	380	93110	7	436	93312	5	420			
84646	3	172, 173	84789	7	226	88255	3	503	93111	4	435	93313	2	420			
84647	0	172, 173	84790	3	226	88256	0	503	93112	1	418	93314	9	430			
84648	7	172, 173, 252, 476	84800	9	171	88271	3	501	93114	5	436	93315	6	430			
84649	4	173, 252, 476	84801	6	171	88285	0	380	93115	2	436	93317	0	422			
84650	0	191	84802	3	171	88287	4	498	93116	9	418	93318	7	421			
84651	7	191	84803	0	170, 171	88288	1	498	93120	6	418	93319	4	436			
84652	4	191	84804	7	170, 171	88598	1	475	93121	3	418	93321	7	139, 392			
84653	1	191	84805	4	171	88607	0	488	93122	0	432	93322	4	410			
84654	8	191	84806	1	171	88608	7	461	93123	7	438	93323	1	410			
84655	5	191	84807	8	170, 171	88609	4	476	93124	4	432	93324	8	417			
84656	2	169	84808	5	170, 171	88617	9	488	93125	1	432	93325	5	415			
84657	8	166	84809	2	170	88618	6	488	93126	8	437	93326	2	414			
84658	5	166	84810	8	170, 171	88626	1	475	93127	5	437	93327	9	412			
84659	2	166	84811	5	171	88627	8	476	93129	9	419	93328	6	412			
84660	9	166	84812	2	171	88628	5	475	93134	3	419	93329	3	412			
84661	6	166, 167	84813	9	171	88636	0	476	93135	0	437	93330	9	409			
84662	3	166, 167	84814	6	170, 171	88637	7	461	93138	1	415	93331	6	411			
84663	0	166, 167	84815	3	170	88640	7	460	93139	8	415	93332	3	411			
84664	7	166, 167	84816	0	170	88642	1	460	93140	4	415	93333	0	411			
84665	4	166, 167	84817	7	170	88643	8	472	93141	1	428	93334	7	413			
84666	1	168	84818	4	170	88644	5	472	93143	5	434	93335	4	413			
84667	8	168	84819	1	170	88645	2	472	93144	2	434	93336	1	412			
84668	5	169	84820	7	182	88675	9	477	93145	9	434	93337	8	412			
84669	2	169	84821	4	182	88688	9	490	93146	6	434	93338	5	412			
84670	9	169	84822	1	182	88701	5	487	93147	3	434	93339	2	413			
84671	6	169	84823	8	183	88710	7	477	93148	0	434	93340	8	413			
84672	3	169	84824	5	182	88717	6	490	93149	7	434	93341	5	413			
84673	0	169	84825	2	182	88718	3	490	93150	3	501	93342	2	411			
84674	7	169	84826	9	182	88727	5	487	93151	0	501	93343	9	411			
84675	4	168, 169	84827	6	182	88810	4	478	93152	7	419	93344	6	411	</		

DE Impressum

Herausgeber: Assheuer + Pott GmbH & Co. KG, Talweg 11, 59846 Sundern, Tel. +49 2933 97350, info@aps-germany.de, www.aps-germany.de

Gestaltung: Assheuer + Pott GmbH & Co. KG · Druck: Druck- und Verlagshaus Fromm GmbH & Co. KG, Breiter Gang 10-16, 49074 Osnabrück

Wir behalten uns das Recht vor, die angegebenen Spezifikationen jederzeit zu ändern. Irrtum, Druckfehler und technische Änderungen vorbehalten. Artikelbeschreibungen sowie Abbildungen und Fotodarstellungen sind ohne Gewähr. Alle Angebote ohne Dekoration. Alle Preise verstehen sich unverbindlich (UVP) in Euro zuzüglich der gesetzlichen Mehrwertsteuer.

© 2019 - Die Vervielfältigung dieses Kataloges - auch wenn partial - muss ausschließlich von der Assheuer + Pott GmbH & Co. KG genehmigt werden.

Bildnachweis: Niklas Thiemann Fotodesign · Shutterstock

GB Imprint

Editor: Assheuer + Pott GmbH & Co. KG, Talweg 11, 59846 Sundern, Germany, Tel. +49 2933 97350, info@aps-germany.de, www.aps-germany.de

Design: Assheuer + Pott GmbH & Co. KG - Print: Druck- und Verlagshaus Fromm GmbH & Co. KG, Breiter Gang 10-16, 49074 Osnabrück, Germany

We reserve the right to alter at any time the specifications stated without notice. Errors, printing error and technical changes reserved. Item description as well as images and illustrations are without guaranty. All offers are without decoration. All prices are without commitment (RRP) in Euro and exclude the legal VAT prescribed by law.

© 2019 - This catalogue may not be reproduced in whole or in part unless specific prior written authorization of Assheuer + Pott GmbH & Co. KG.

Picture credits: Niklas Thiemann Fotodesign · Shutterstock

ES Impressum

Editor: Assheuer + Pott GmbH & Co. KG, Talweg 11, 59846 Sundern, Alemania, Tel. +49 2933 97350, info@aps-germany.de, www.aps-germany.de

Diseño gráfico: Assheuer + Pott GmbH & Co. KG - Impresión: Druck- und Verlagshaus Fromm GmbH & Co. KG, Breiter Gang 10-16, 49074 Osnabrück, Alemania

Nos reservamos el derecho de efectuar modificaciones en cualquier momento, sin aviso previo. Salvo errores de imprenta o impresión o cambios técnicos. La descripción de los artículos, sus imágenes e ilustraciones son sin garantía. Los artículos se ofrecen sin decoración. Todos los precios indicados son precios sugeridos (PVR) en euros y a dichos precios se deberá añadir el impuesto sobre el valor añadido legal vigente.

© 2019T - Todas las reproducciones, aunque parciales, de este catálogo tienen que ser autorizadas por escrito por Assheuer + Pott GmbH & Co. KG.

Derechos de la imagen: Niklas Thiemann Fotodesign · Shutterstock

FR Impressum

Éditeur: Assheuer + Pott GmbH & Co. KG, Talweg 11, 59846 Sundern, Allemagne, Tel. +49 2933 97350, info@aps-germany.de, www.aps-germany.de

Design: Assheuer + Pott GmbH & Co. KG - Impression: Druck- und Verlagshaus Fromm GmbH & Co. KG, Breiter Gang 10-16, 49074 Osnabrück, Allemagne

Nous nous réservons le droit de modifier à tout moment les spécifications. Toutes erreurs, fautes d'impression et modifications techniques sont réservées. Les descriptions d'articles, les illustrations et les photos sont sans garantie. Toutes les articles s'entendent hors décoration. Tous les prix sont donnés sans engagement (PVC) et s'entendent en Euro et T. V. A. légale en vigueur non incluse.

© 2019 - toute reproduction même partielle de ce catalogue est interdite sauf autorisation expresse de Assheuer + Pott GmbH & Co. KG.

Crédit photo: Niklas Thiemann Fotodesign · Shutterstock



buffet | tabletop | bar

Assheuer + Pott GmbH & Co. KG

Talweg 11 | 59846 Sundern | Germany

Telefon +49 (0) 29 33 / 97 35 - 0

Telefax +49 (0) 29 33 / 97 35 - 35 (Zentrale)

Telefax +49 (0) 29 33 / 97 35 - 34 (Export)

info@aps-germany.de | aps-germany.de

KATALOG NR 46

CATALOG NO 46

CATÁLOGO N° 46

CATALOGUE N° 46



Follow us on
[aps_germany](https://www.instagram.com/aps_germany)

